



Assembly Instructions

Caution : You must read this before you proceed



End Table

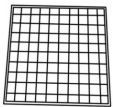

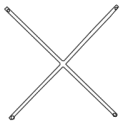
Parts List

Label	Picture	Description	QTY
A		Table Top	1
B		Left Leg Frame	1
C		Right Leg Frame	1
D		"X" Iron Stretcher	1

Hardware

Label	Picture	Description	QTY
①		Nut	9
②		Wrench	1

Assembly Preparation

Before Beginning Assembly:

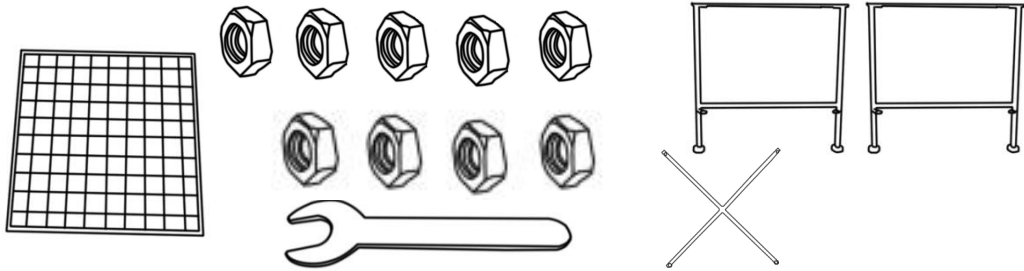

- Read instructions, cover to cover-



- Have 2 adults on hand for assembly-



- Do not assemble on flooring or carpet-



- Assemble on a clean non-marring surface (packing foam)-



- Save all packaging until finished-

Assembly Steps

Overview

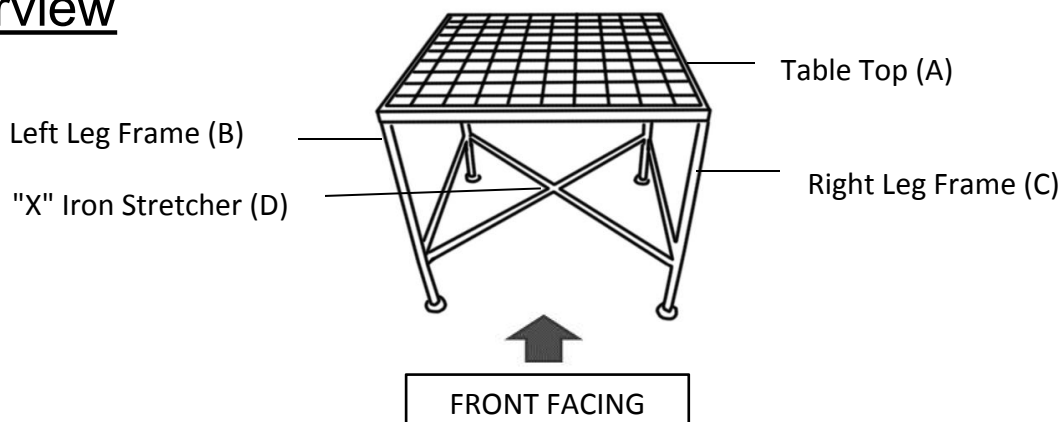

This End Table has multiple parts and may require up to 30 minutes to assemble. To give you an overview of the Table parts, the above picture is to help you put the various parts into perspective. Please read through the instructions below to familiarise yourself with the parts and steps before assembly.

Step 1

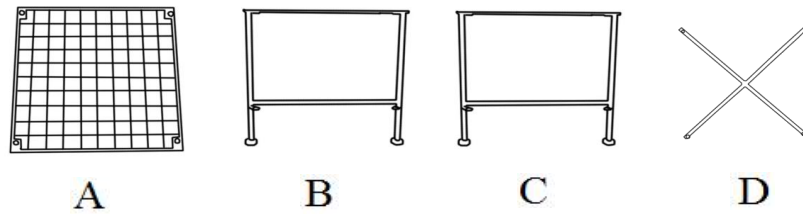

Open the carton and place all parts on a clean, non-marring surface.

Step 2

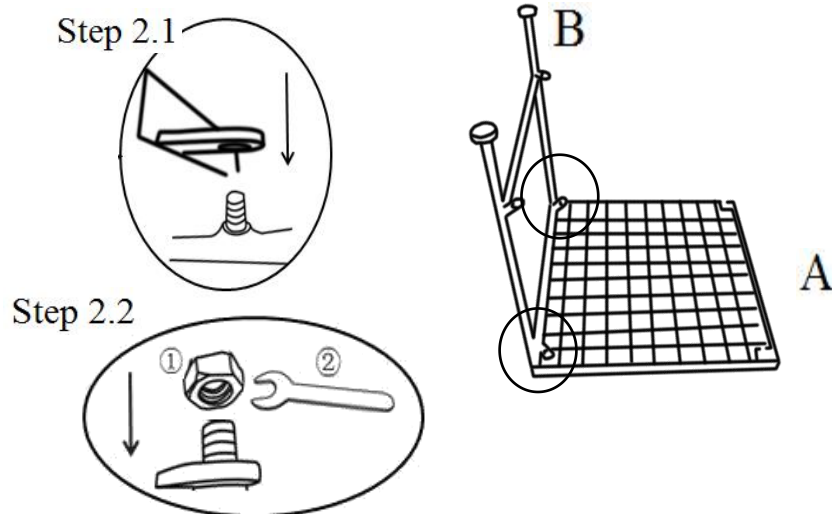

Place the Table Top(A) face down on the clean and soft surface.

2.1) Insert Left Leg Frame(B) into Table Top(A) as shown above.

2.2) Attach Left Leg Frame(B) to Table Top(A) using Nuts(①) with Wrench(②) as shown above.

Do not fully tighten the Nuts.

Step 3

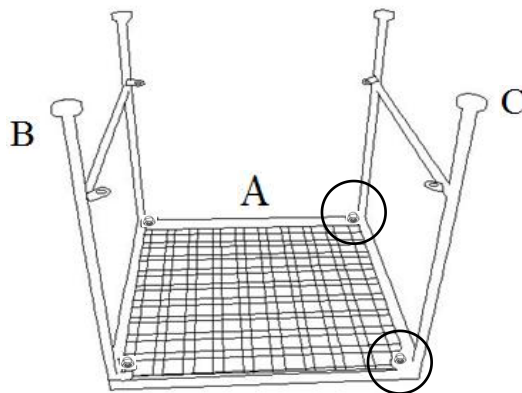

Repeat Step 2, to attach Right Leg Frame(C) to Table Top(A).

Do not fully tighten the Nuts.

Step 4

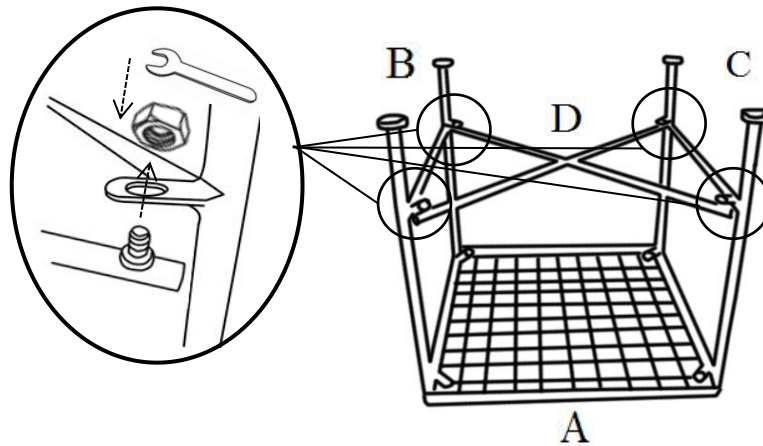

Attach the "X" Iron Stretcher(D) to Left Leg Frame(B) and Right Leg Frame(C) using the Nuts(①) with Wrench(②).
Do not fully tighten the Nuts.

Step 5

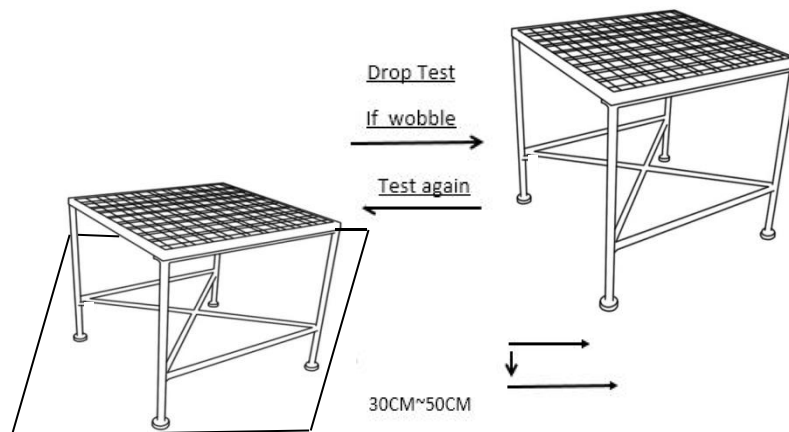

Stand the Table right way up. Place the Table on a LEVEL SURFACE to check for wobbles.

If it wobbles, lift the table some 20cm to 30cm high from the ground.

Keep your feet and toes well away from the drop zone.

Drop the table freely and vertically with all four legs, hitting the ground, at the same time.

This Drop Test will help to ensure that all Nuts and gaps reach full alignment status.

Test again for evenness on a LEVEL SURFACE.

If no wobbles are found, slowly and carefully, turn the Table facedown.

Then, proceed to tighten all Nuts in a sequential manner.

When tightening the Nuts, tighten sequentially.

DO NOT tighten any Nut fully and then towards the next one.



















This could cause the frame to warp. If there are still wobbles, loosen the Nuts and execute the same drop test.

If the Table is not stable, it could lead to damage to the product.

Your End Table is ready for use.

This Table can only be used on a flat, level surface.

Care & Maintenance

-   ● Do not put hot items directly on furniture surface
 -   ● Do not clean furniture with harsh cleansers or polish.
 -   ● To obtain the longest lifespan of your outdoor products, minimizing exposure to direct sunlight is recommended.
 -   ● Children should not climb or jump on the furniture.
 -   ● Do not write on furniture without a padded barrier to protect the surface.
 -   ● To obtain the longest lifespan of your outdoor products, avoid extended and lengthy exposure to rain, snow, and direct sunshine. Whenever possible cover the product and /or place under patio or awnings.
 -   ● Not for commercial use. For residential use only .
 -   ● Stains may be removed with mild soap solution and damp cloth.
-
-   ● Dust and pick-up spills using a clean, non-colored, lint-free cloth .