

Installation & Assembly

we recommend using the included manual installation tool for assembly.
If you choose to use a power drill, please set it to the lowest torque setting
to prevent over-tightening, which may damage the wooden panels.

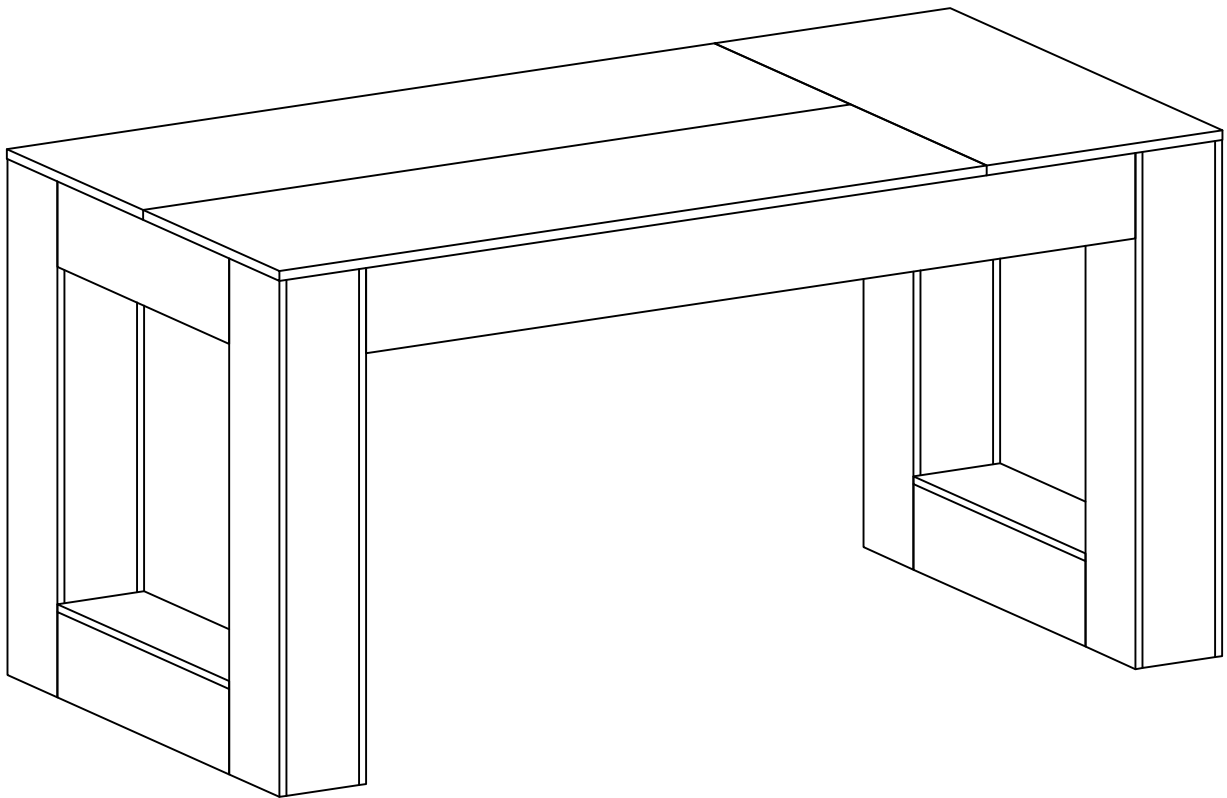

Parts List

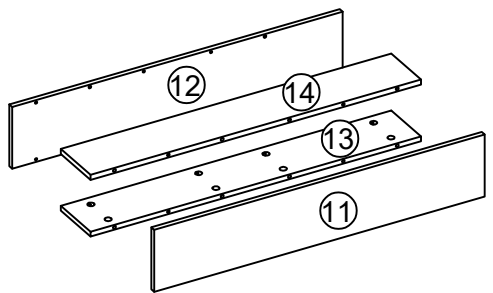
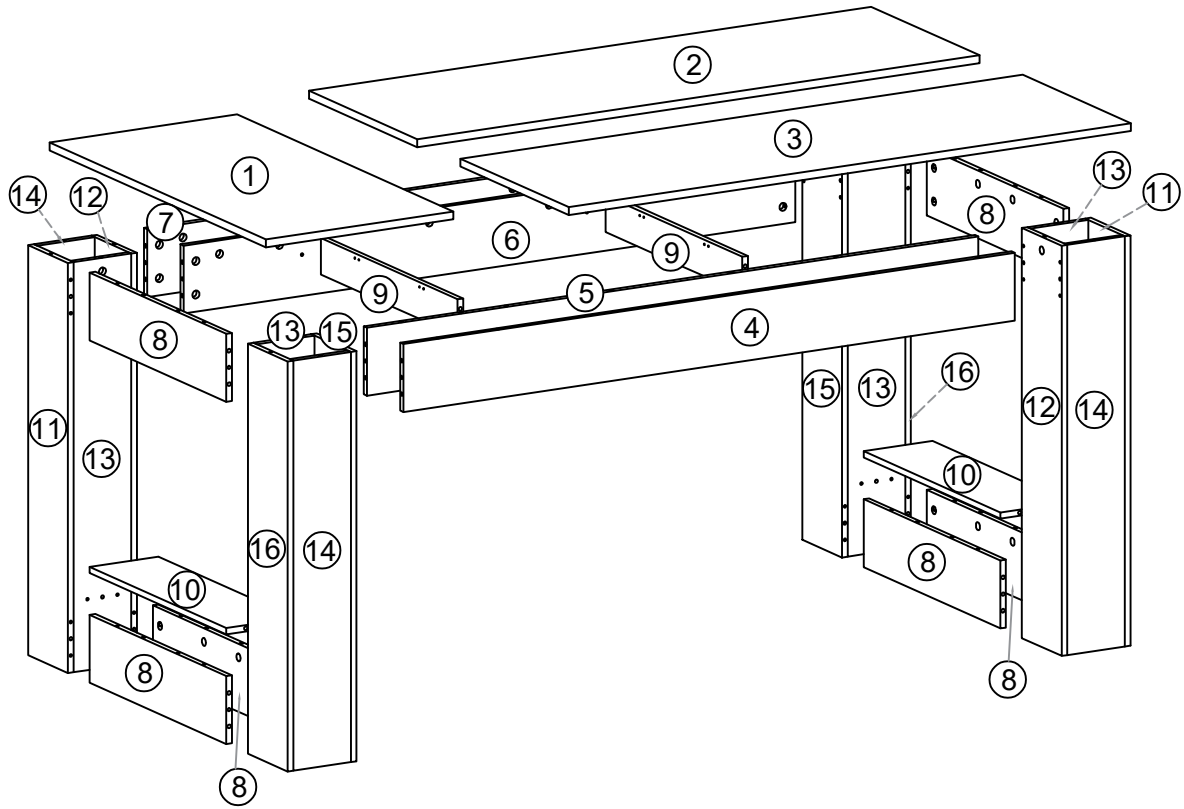

X2

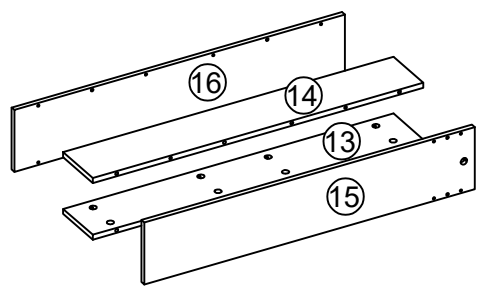

X2

Hardware

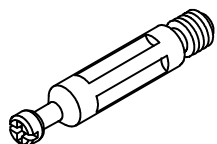

A x 172sets

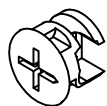

∅15X9.5MM

B x 188sets

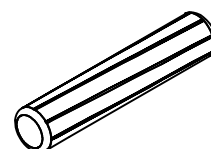

∅6 x 30MM

C x 78pcs

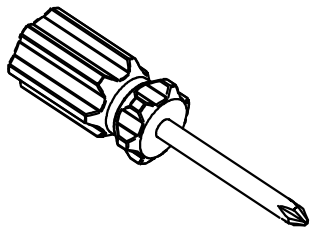

D x 1sets

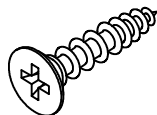

3.5 x 12MM

E x 34pcs

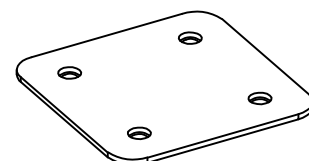

F x 2pcs

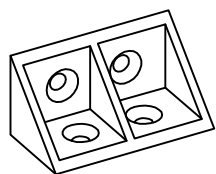



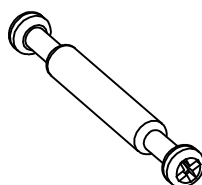

G x 6sets

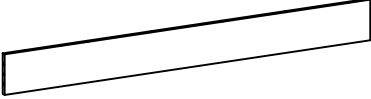

H x 8sets

ASSEMBLY MATERIAL

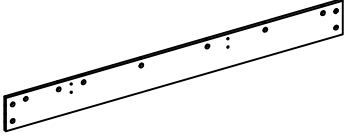
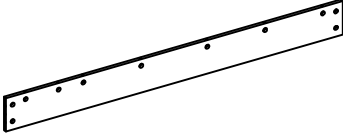
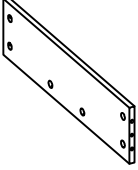
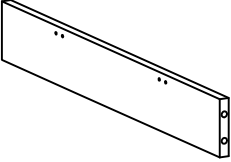
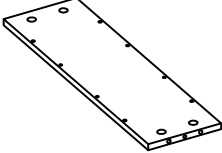
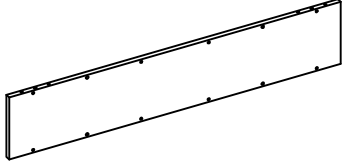
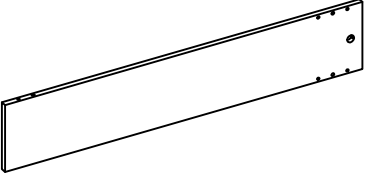
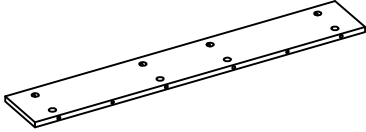
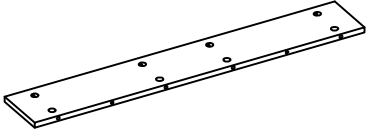
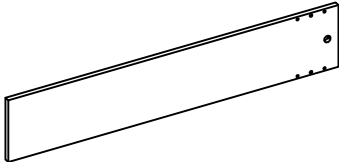
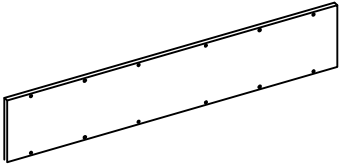
Item no.	Reference Image	Qty.	Item no.	Reference Image	Qty.
①		X1	②		X1
③		X1	④		X1
⑤		X1	⑥		X1
⑦		X1	⑧		X6
⑨		X2	⑩		X2
⑪		X2	⑫		X2
⑬		X4	⑭		X4
⑮		X2	⑯		X2

Step 1

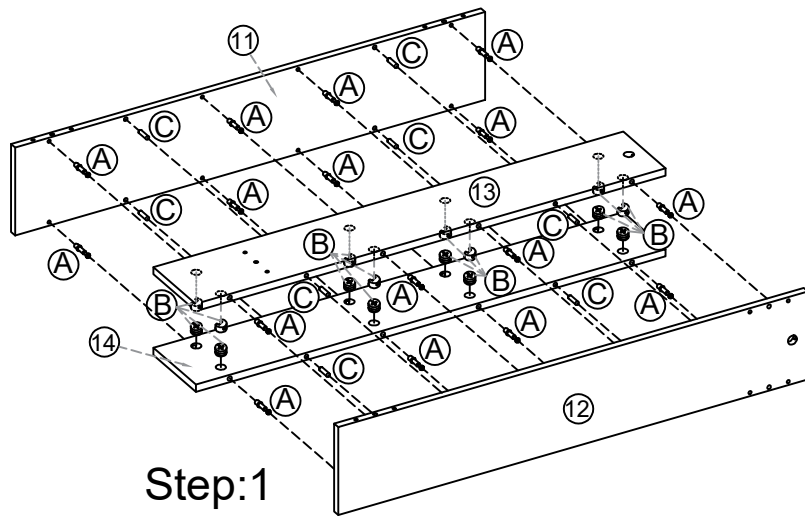
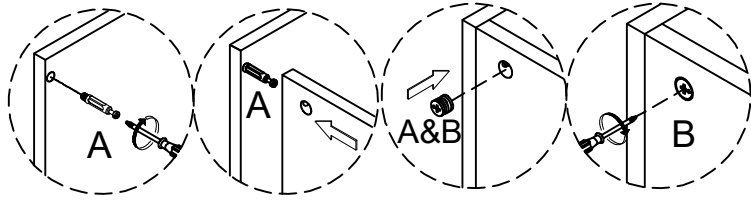
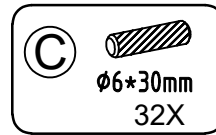
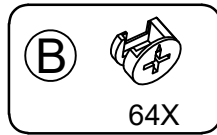
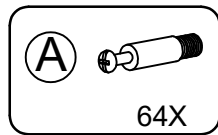

Step:1

X2

Step:2

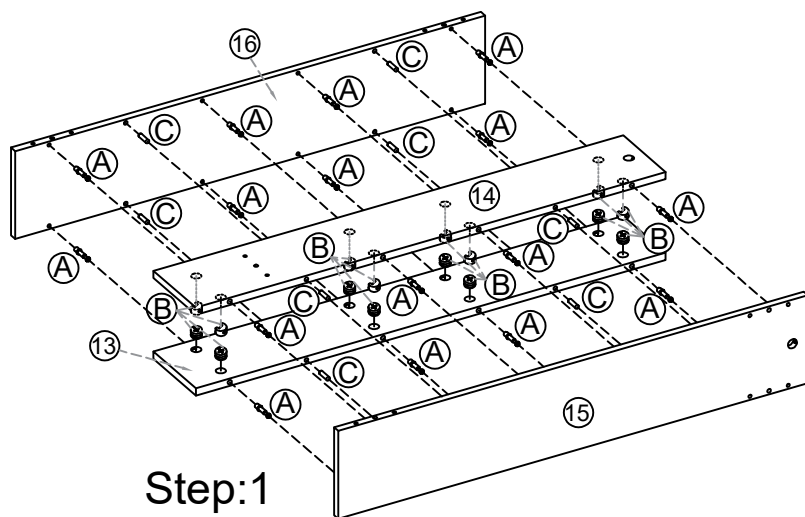
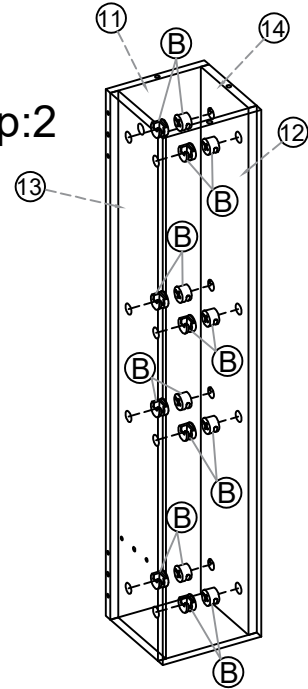

Step:1

X2

Step:2

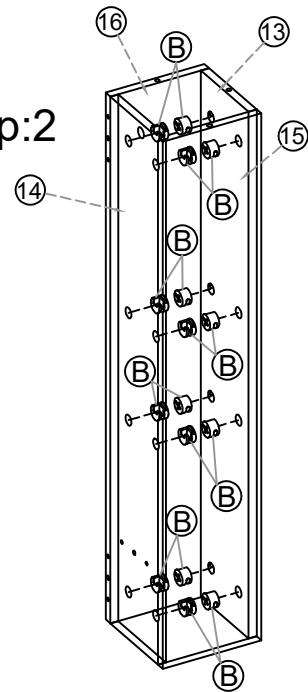

Note: When tightening with a screwdriver, you need to insert your hand into the foot to tighten

Step 2

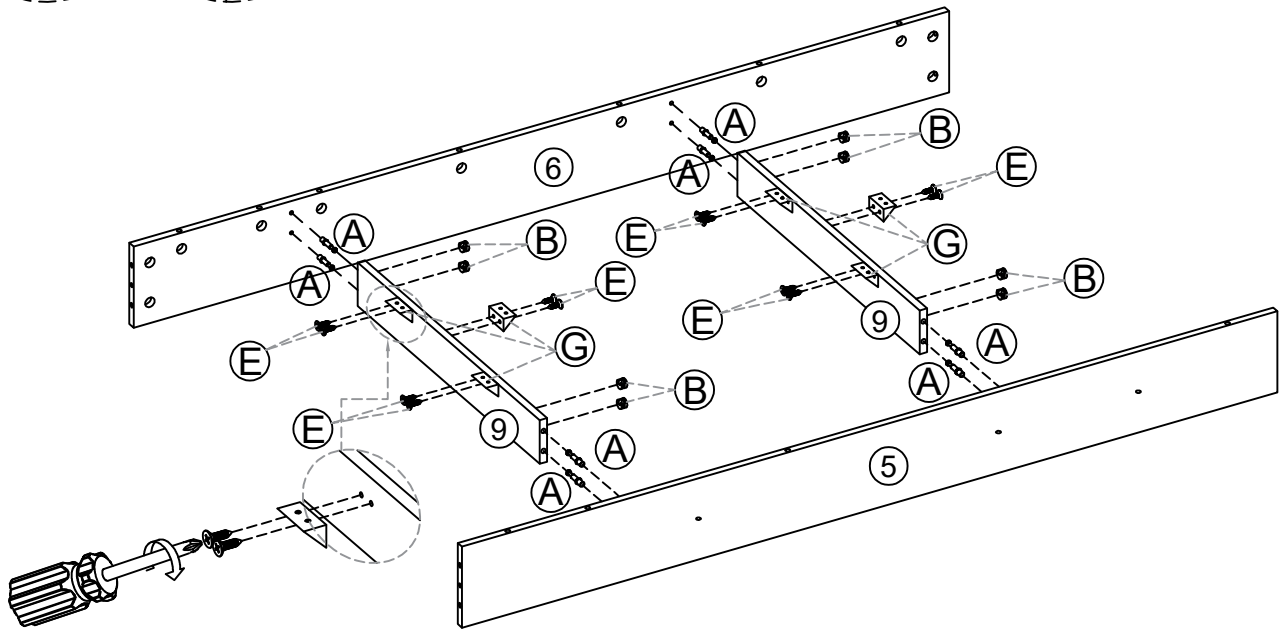
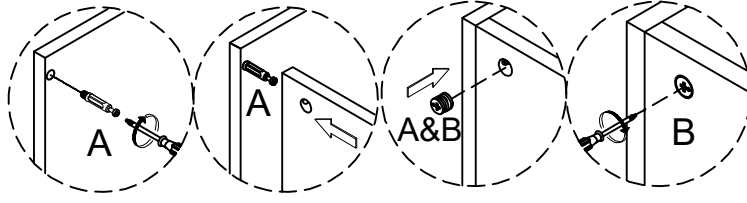
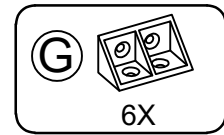
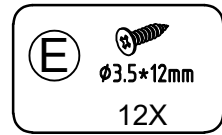
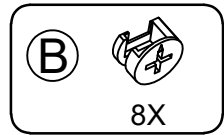
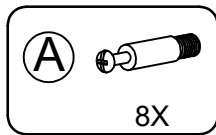

Step 3

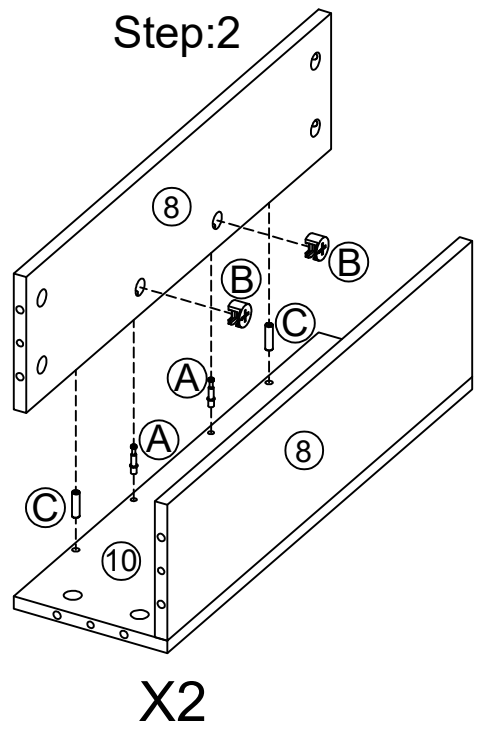
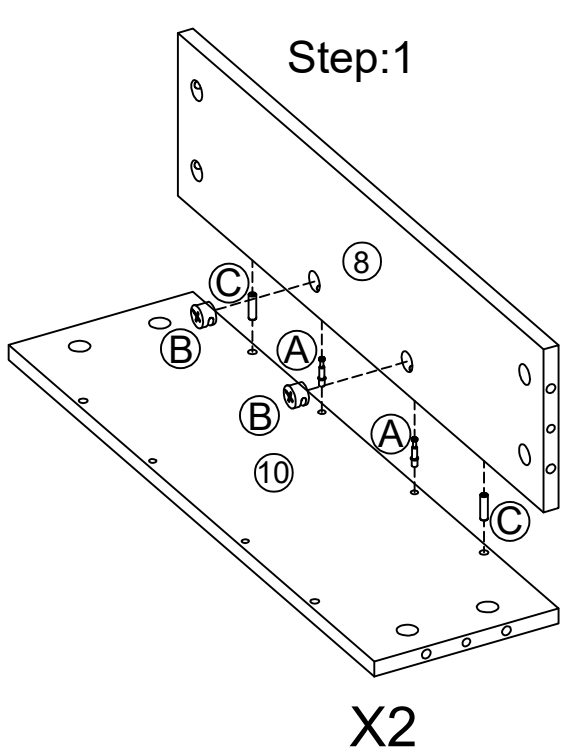
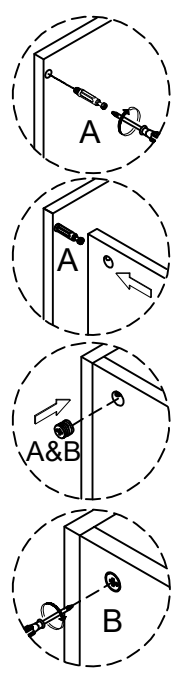
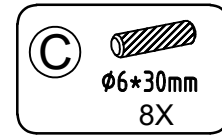
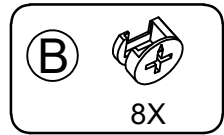
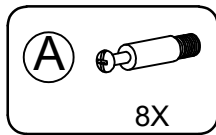

Step 4

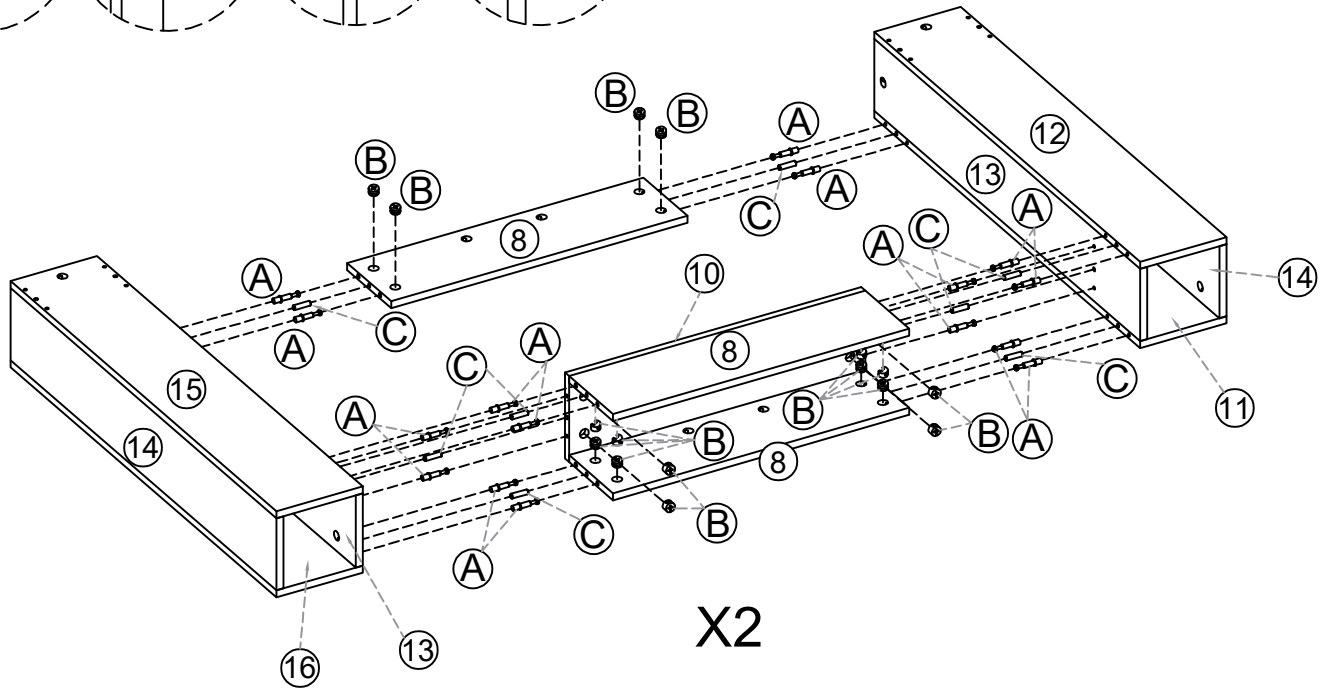
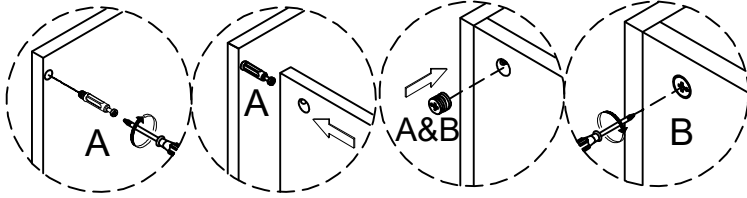
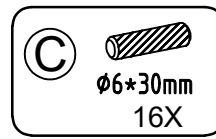
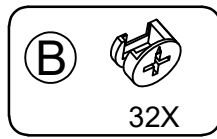
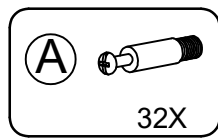

Step 5

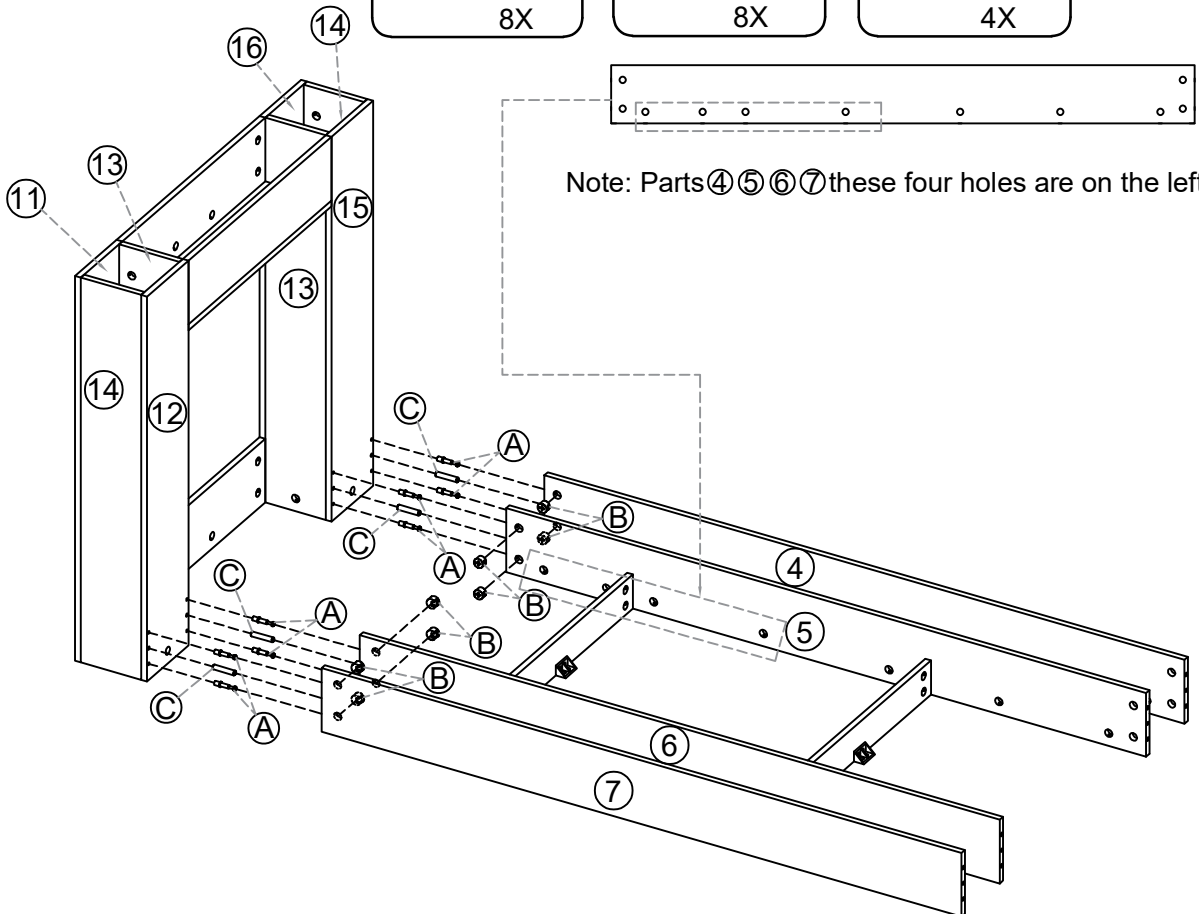
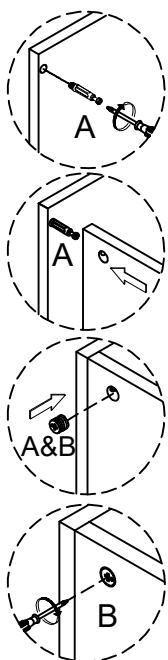
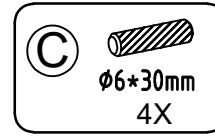
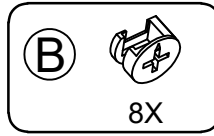
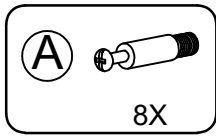

Note: Parts ④ ⑤ ⑥ ⑦ these four holes are on the left side

6Step 6

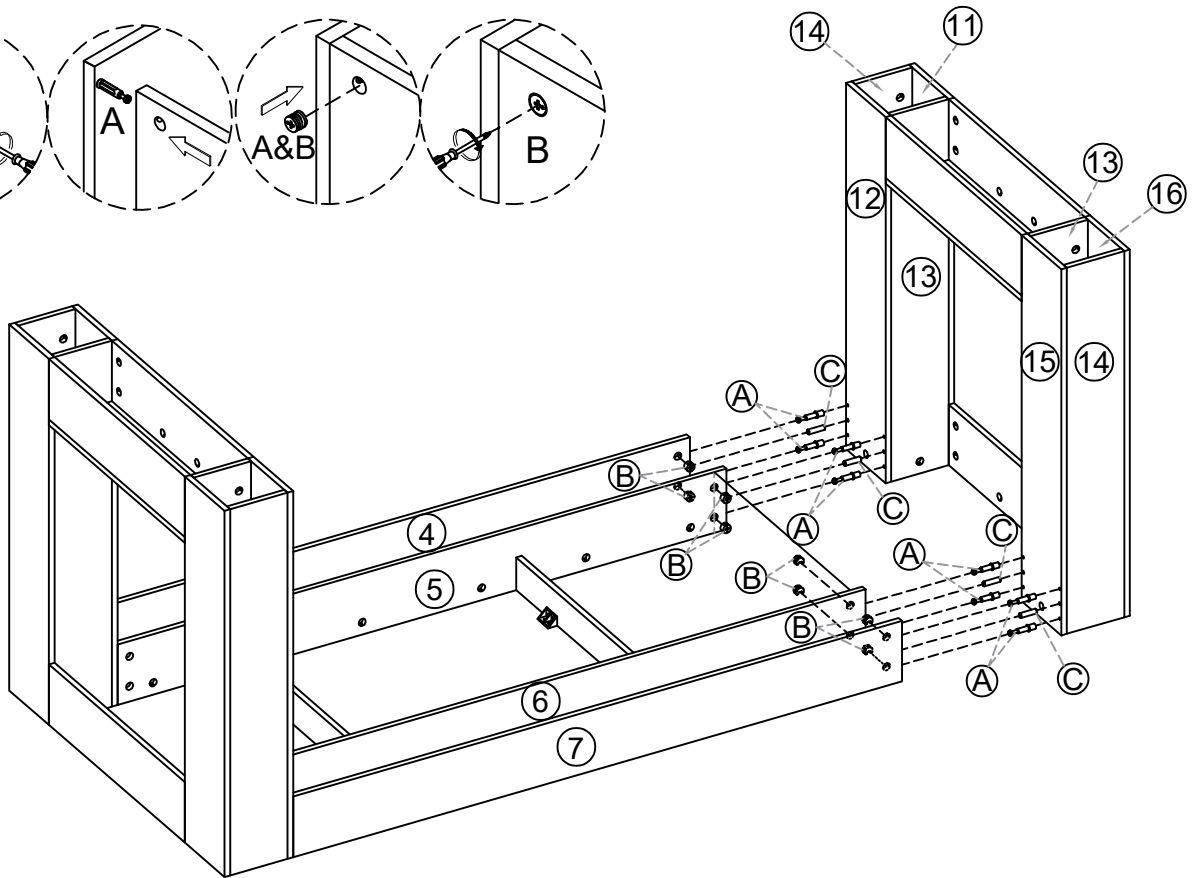
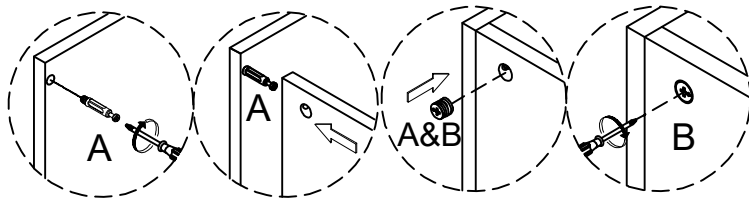
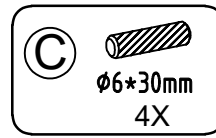
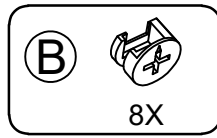
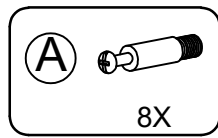

Step 7

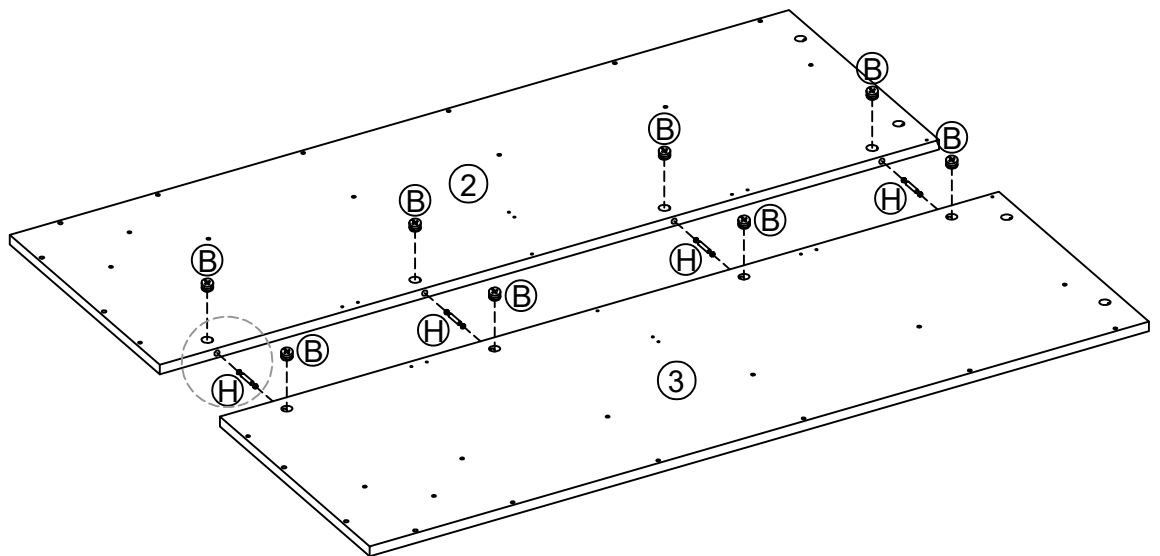
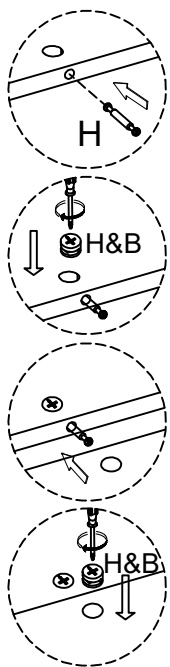
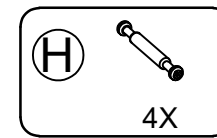
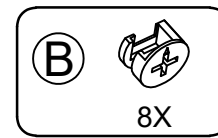

Step 8

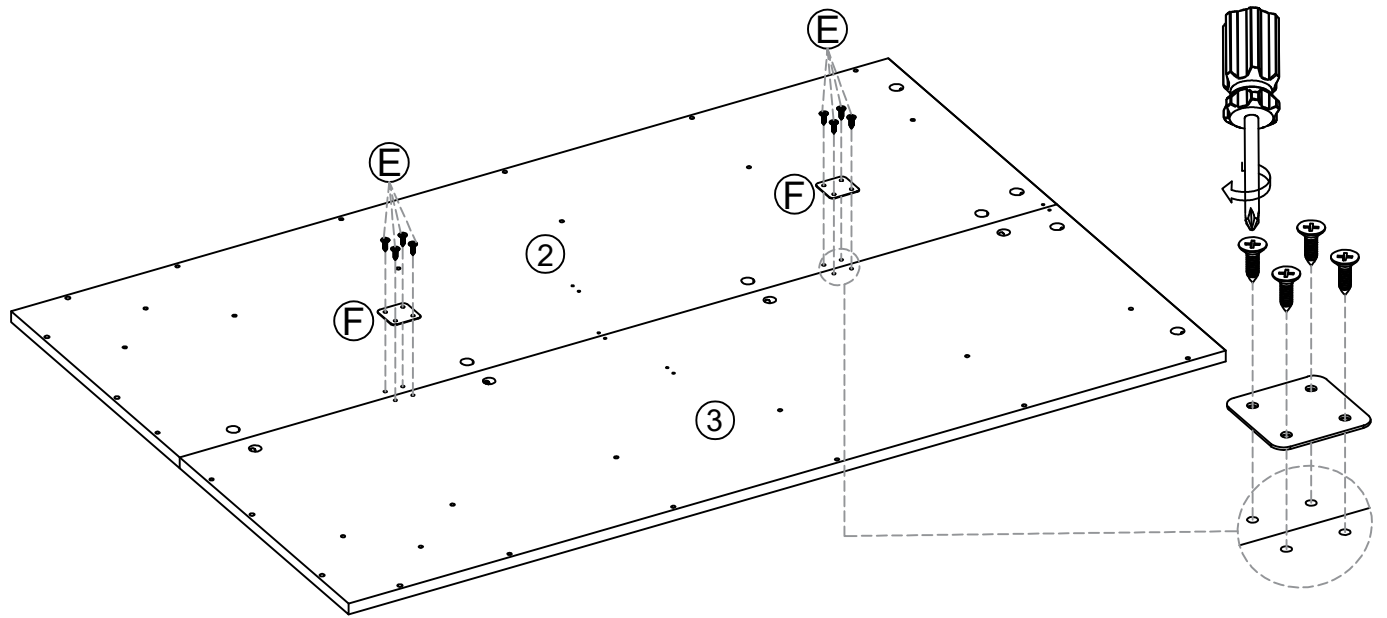
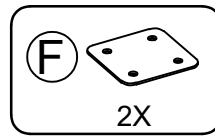
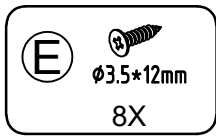

Step 9

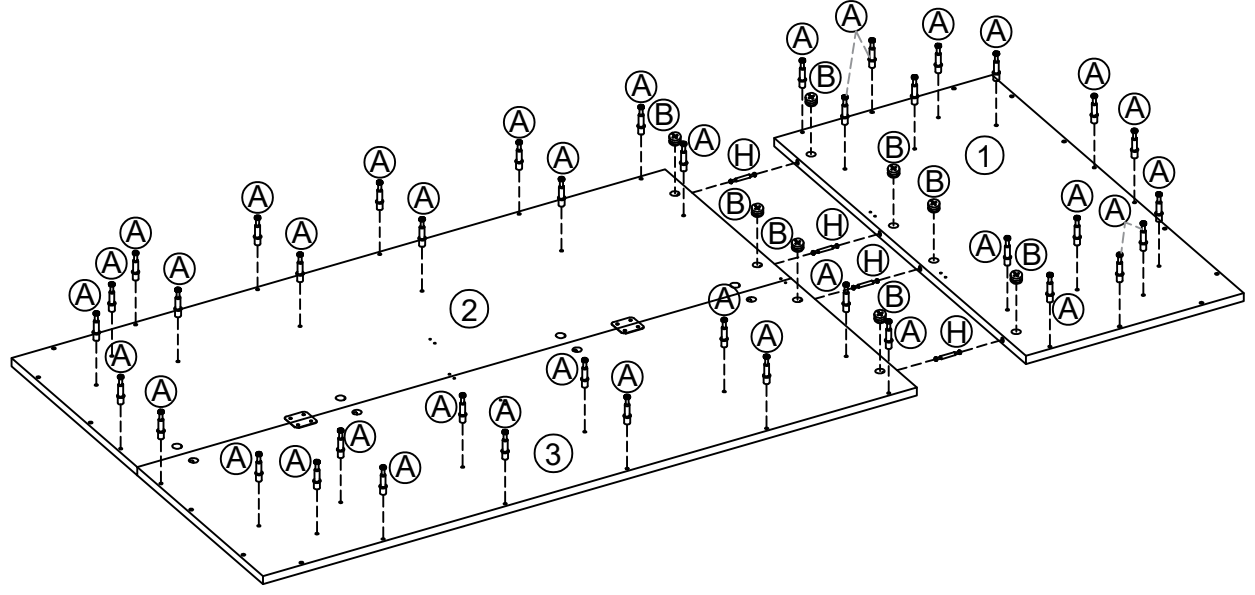
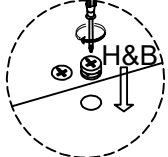
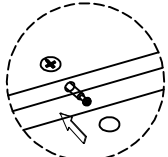
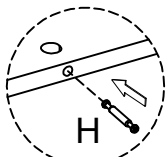
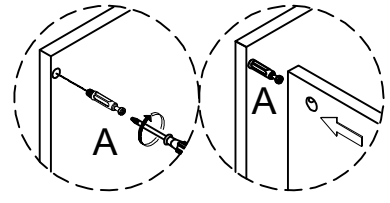
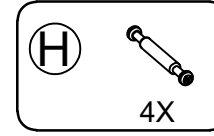
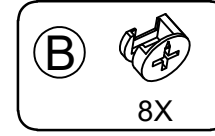
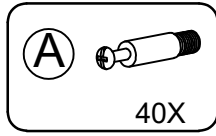

Step 10

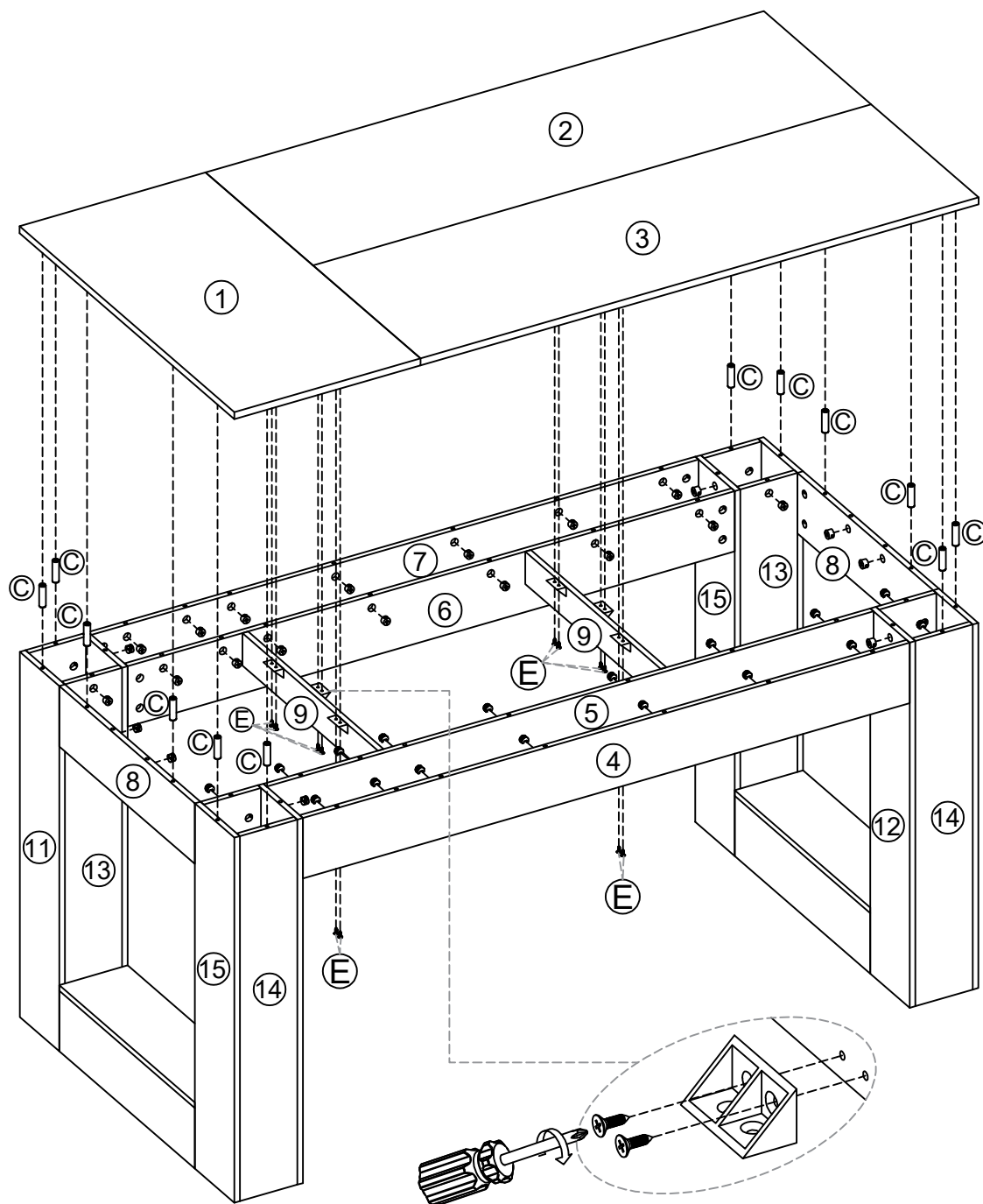
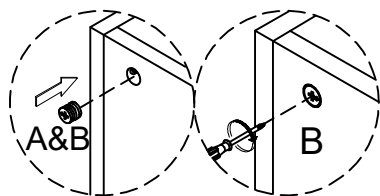
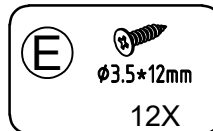
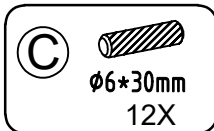
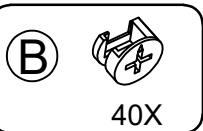

Ⓐ is already locked in the panels ① ② ③ in advance, simply lower the panel to place Ⓐ into the corresponding holes, as shown: hole corresponding to the lock plate Ⓑ

Step 11

