

INSTALLATION MANUAL

WARRANTY & SERVICES

1 year warranty services are provided for this light fixtures.

We provide 24-hour customer service, and any questions you have will be answered within 24 hours. If you have any questions or problems during the warranty period, please feel free to contact us via email, your order ID and details are preferred so that our customer service will help you more quickly and accurately!

Note: please use this light fixture accordingly to its intended purpose, do not retrofit or remodeling this light fixture. The warranty does not cover if the failure is caused by the third party product, or natural disasters.

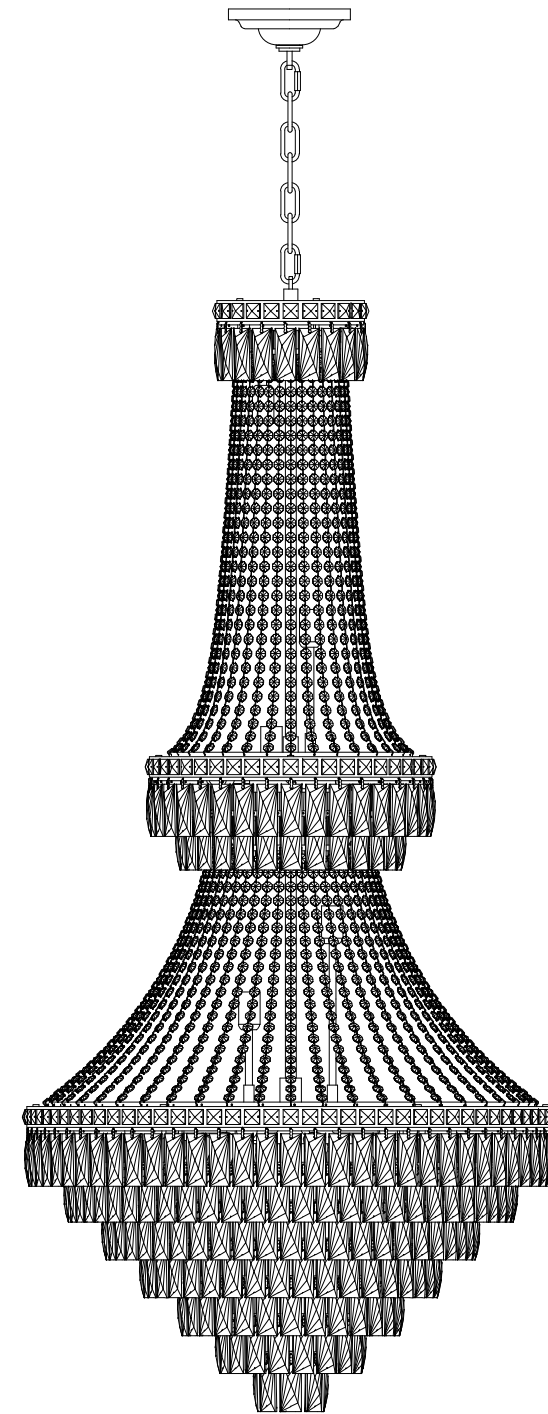

- ◆ Require 26 pieces E12 bulbs(110V, Max 60W),not included in package, if you want it dimmable, please purchase a dimming bulbs with matched dimmer.
- ◆ For transportation safety, the product needs to be partially assembled
- ◆ please wear gloves for installation, especially when hanging crystals



SAFETY INSTRUCTIONS

These instructions are provided for your safety. It is very important that they are read completely before beginning the installation of your fixture.

1. WE RECOMMEND INSTALLATION BY A LICENSED ELECTRICIAN.
2. This fixture require 26 pieces E12 bulbs(not included in product), bulb rated wattage Max 60W. To avoid risk of fire, do not exceed the recommended wattage.
3. If any special control devices are used with this fixture, follow the instructions carefully to assure full compliance with N.E.C. requirements. If there are any questions, contact a qualified electrical contractor.
4. please make sure shut off the main electrical supply before installation, changing bulbs or cleaning light fixture.



WARNINGS

THIS IS NOT A TOY AND THE PRODUCT HAS NO PLAY VALUE.

Keep at least 3 ft away from cribs, bassinets, and toddler beds.

Keep out of reach of children under 3.



PREPARATION

1. Before begining installation, make sure all parts are included refer to the contents diagrams(PACKAGE CONTENTS). if any Part is missing or damaged, do not attempt to assemble, install or operate the product.
2. 26 pieces E12 bulbs(Max.60W) are required.
3. Any question or problem, please feel free to contact us.

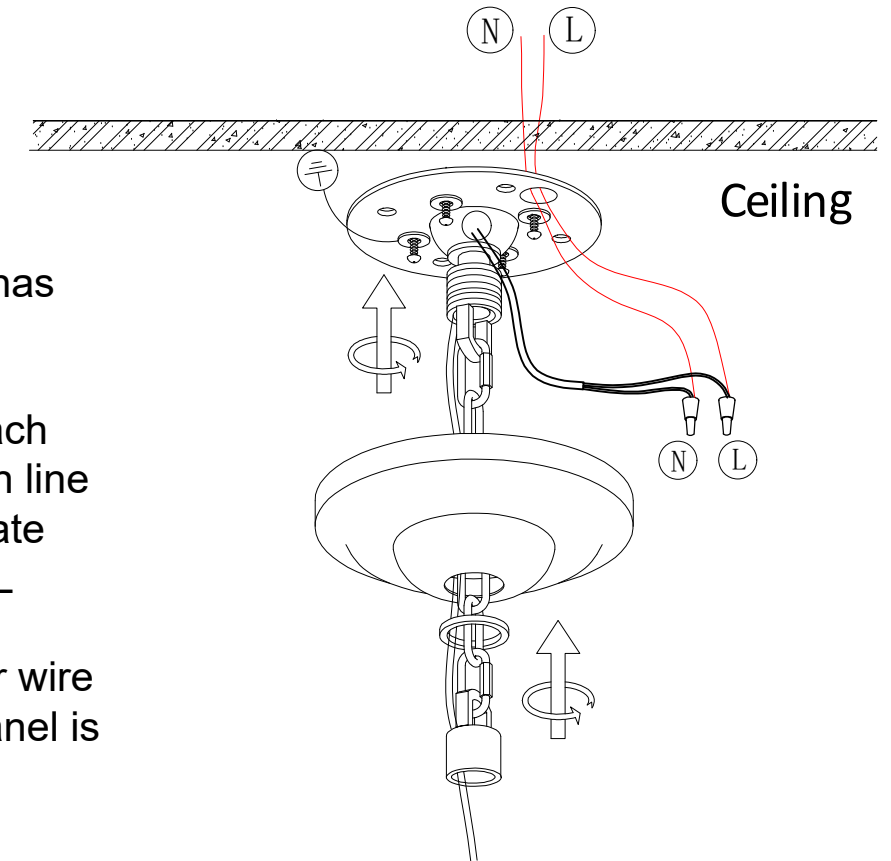

Notes:

1. The lamp body has two main wires
2. Two wires on each transparent main line do not differentiate between N and L
3. The bare copper wire on the ceiling panel is the ground wire

NOTES:

The diagram is only for reference installation method of ceiling plate, please install according to the actual ceiling situation.

If you don't need such a long chain, please cut it appropriately short before hanging it. If you want to increase the length of the hanging chain and wires, please purchase eligible wires and hanging chains that meet the standards and replace and install it by professional electricians.

WARNING: Never connect ground wire to black or white power supply wires.

please make sure shut off the main electrical supply before installation.

Please do not connect two wires on the same transparent wire together.

Step VII

Overall rendering after installation

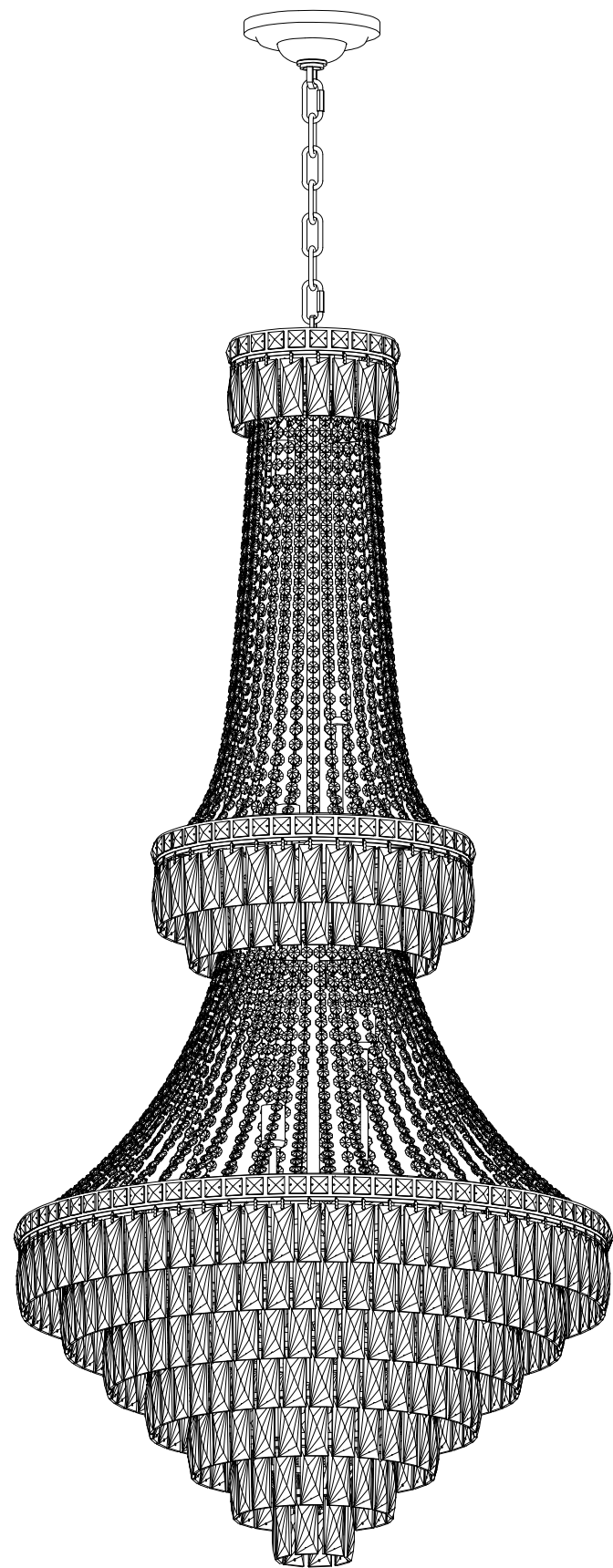

PACKING CONTENTS

The main accessories are listed below, all fragile or easily lost parts (including during transportation and installation) have spare parts, please rest assured of installation

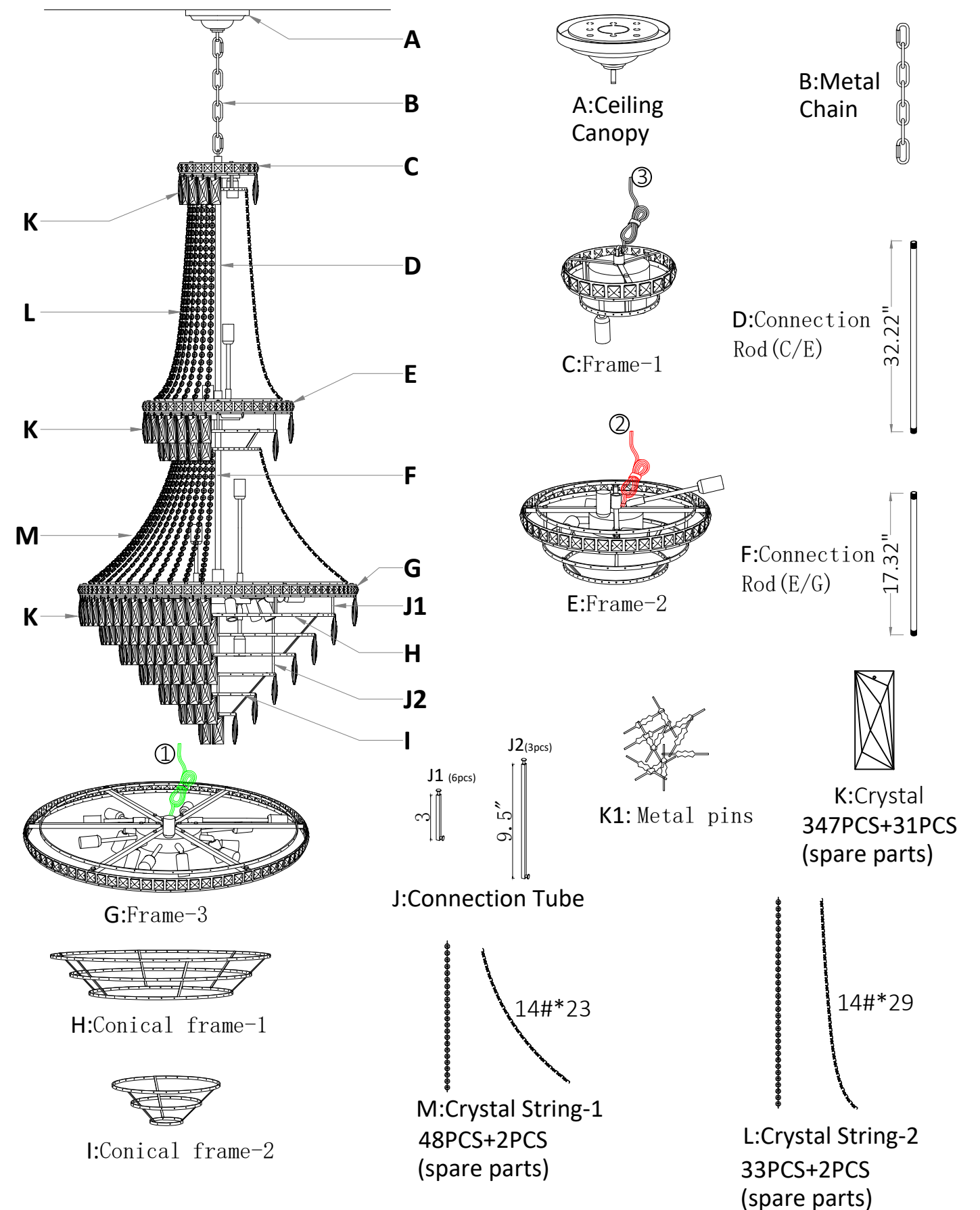

INSTALLATION STEPS

Step I

Adjust the position of bulb holders on Frame-3(G) as shown.
Install Conical frame(H and I) on Frame-3(G) with Connection tube(J1 and J2).

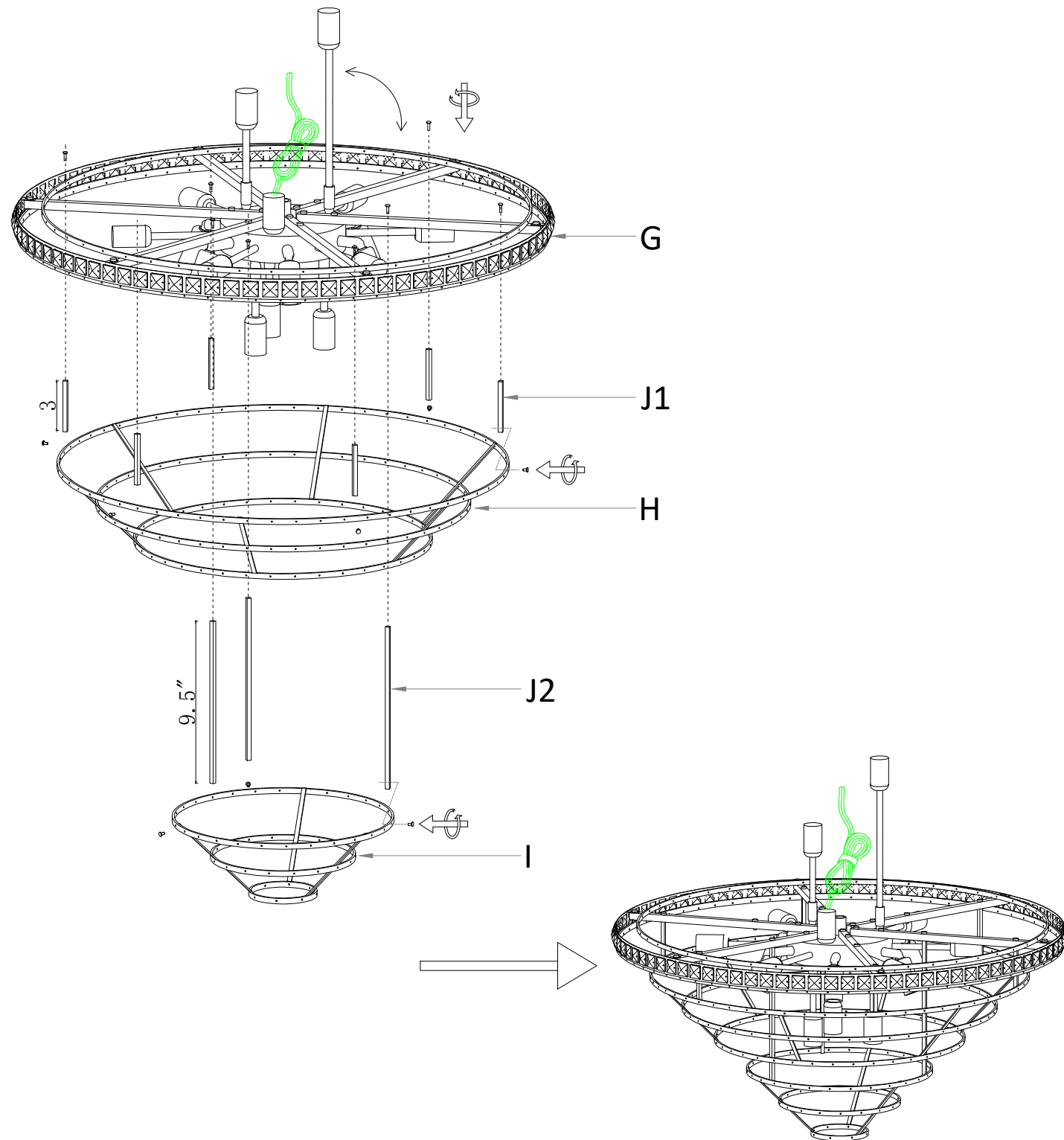

INSTALLATION STEPS

Step VI

Hanging crystal "K" "L" "M" to the corresponding location as shown.

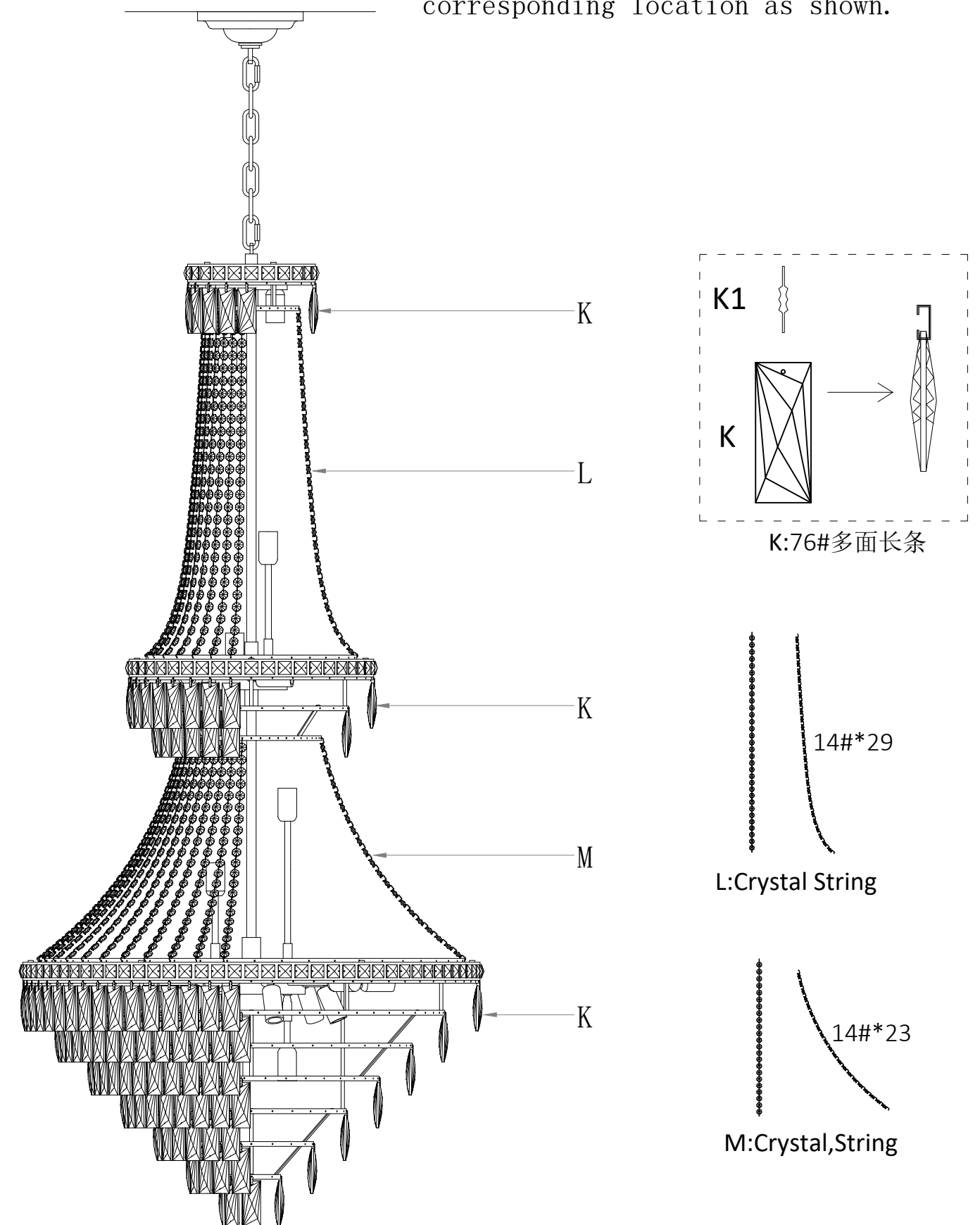

LLATION STEPS

Step V

Remove the mounting bracket from ceiling canopy(A) and install it on the ceiling.
Connect lamp wires with house wires.
then hanging the lamp frame on the ceiling
(details on page 11)
Put on E12 bulbs, and power-on test.

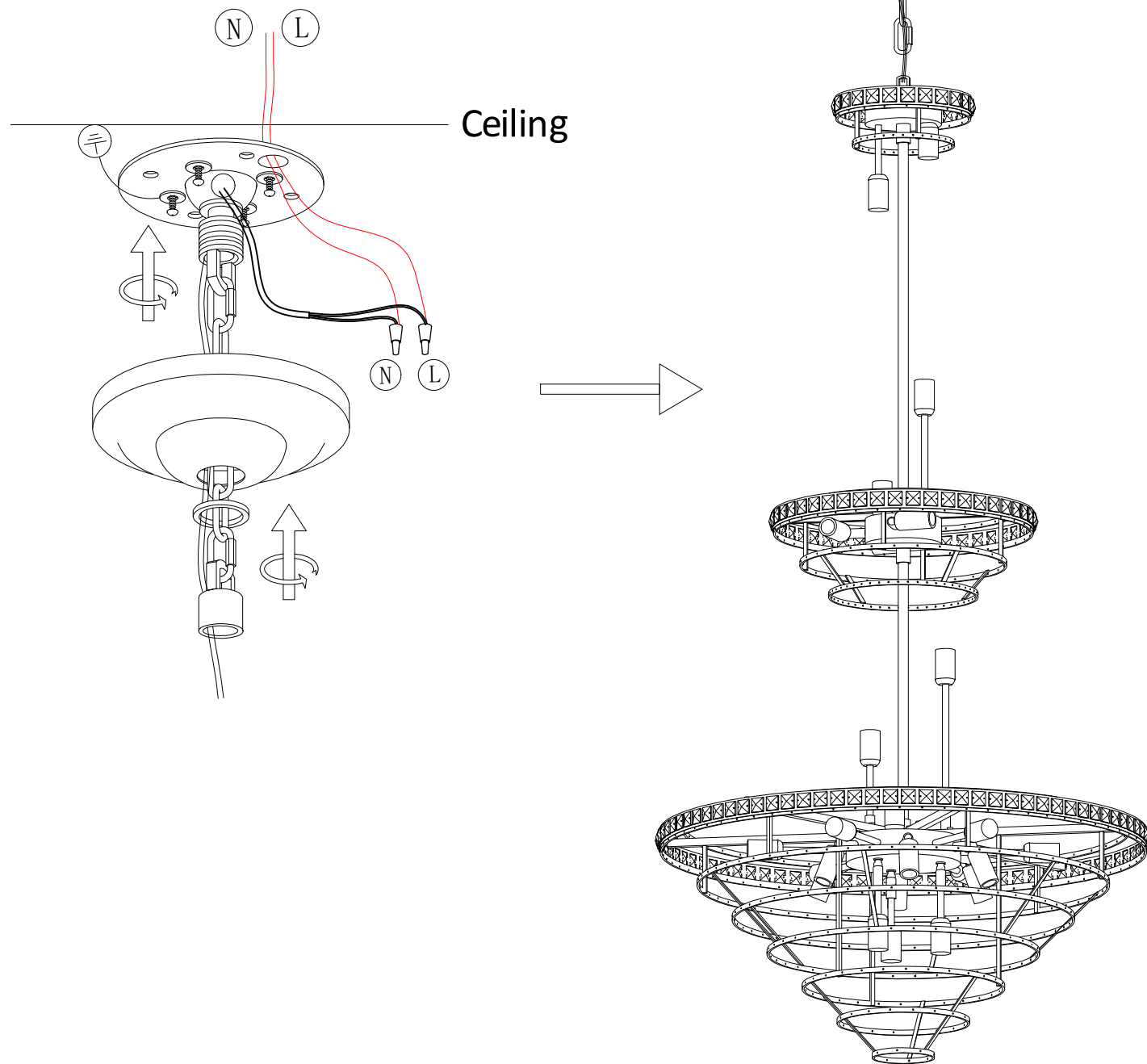

INSTALLATION STEPS

Step II

Pass the main wire(1) on Frame-3(G) through Connection Rod(F), and fix conection rod(F) on Frame-3(G).
Then Pass the main wire(1) through Frame-2(E), and fix Frame-2(E) on Connection Rod(F).

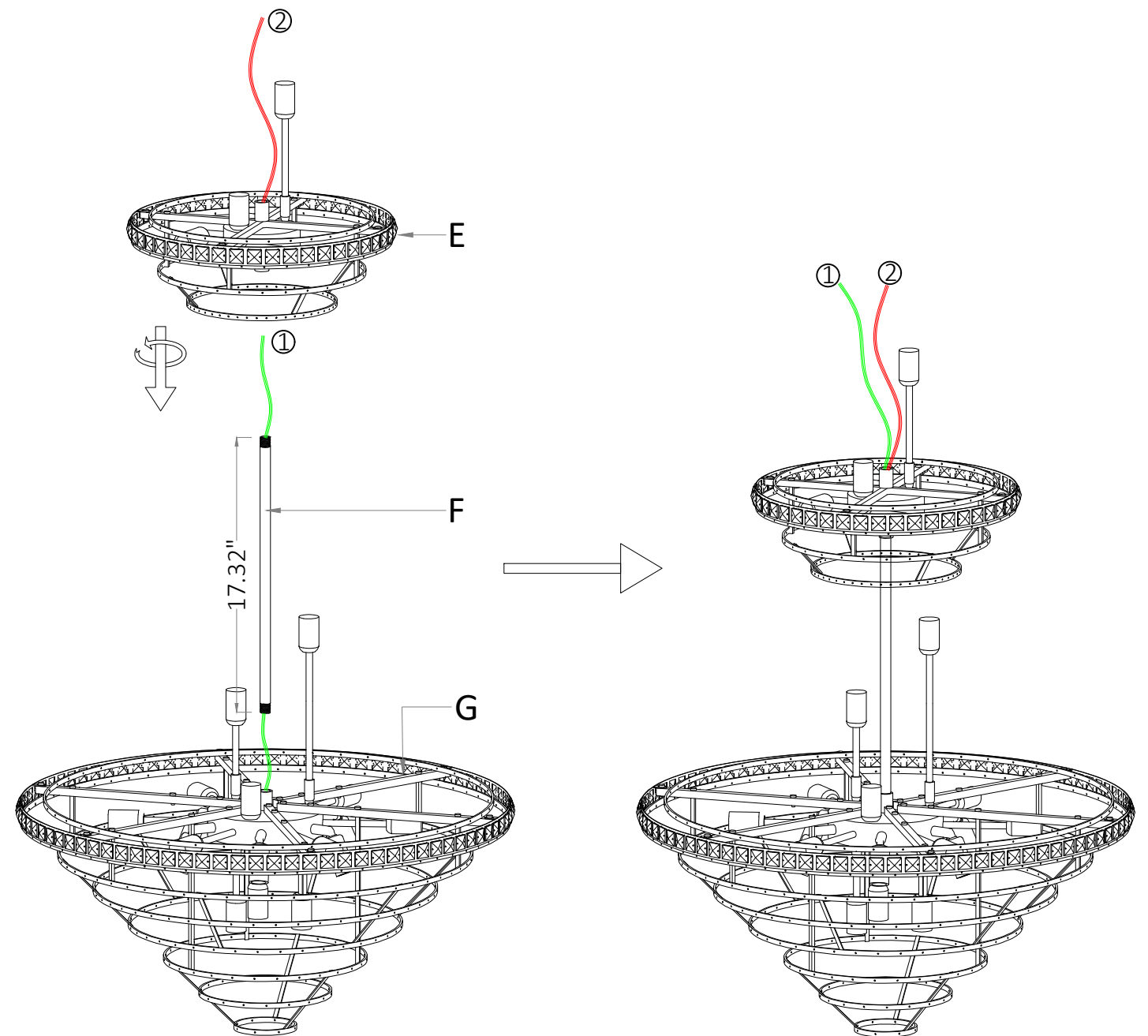

LLATION STEPS

Step III

Pass the main wire ① and ② through Connection Rod(D), and fix connection rod(D) on Frame-2(E).

Open the box on frame-1(C), connect wires ①, ②, bulb holders wires on frame-1(C) with main wire ③ together. then install frame-1(C) on connection Rod(D) as shown.

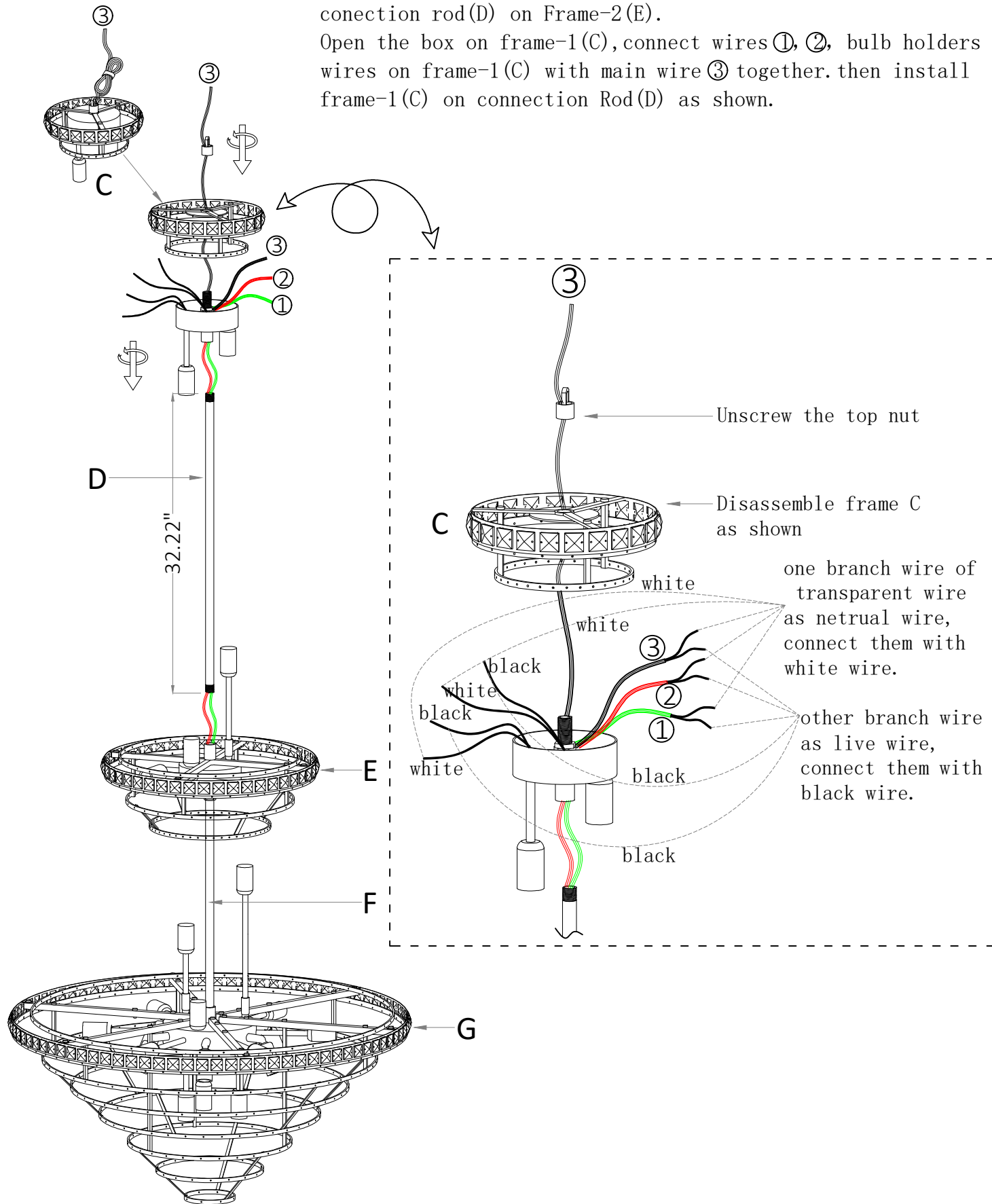

INSTALLATION STEPS

Step IV

Connct lamp frame with ceiling canopy(A) with metal chain(B). pass main wire ③ through metal chain and ceiling canopy.

