

▲ AVERTISSEMENT	▲ WARNING	
<p><b>Des enfants sont morts à cause du renversement de meubles. Pour réduire le risque de renversement des meubles:</b></p> <ul style="list-style-type: none"> <li>• Installez TOUJOURS le dispositif anti- basculement fourni.</li> <li>• NE JAMAIS placer un téléviseur sur ce produit.</li> <li>• NE JAMAIS laisser un enfant se tenir debout sur les tiroirs, les portes ou les tablettes, y grimper ou s'y suspendre.</li> <li>• N'ouvrez JAMAIS ouvrir plus d'un tiroir à la fois.</li> <li>• Mettre les objets les plus lourds dans les tiroirs du bas.</li> </ul> <p><i>Cette étiquette est permanent Ne pas la retirer !</i></p>	<p><b>Children have died from furniture tipover. To reduce the risk of furniture tipover:</b></p> <ul style="list-style-type: none"> <li>• ALWAYS install anti-tip device provided.</li> <li>• NEVER put a TV on this product.</li> <li>• NEVER allow children to stand, climb, or hang on any drawers, doors or shelves.</li> <li>• NEVER open more than one drawer at a time.</li> <li>• Place heaviest items in the lowest drawers.</li> </ul> <p><i>This is a permanent label. Do not remove !</i></p>	

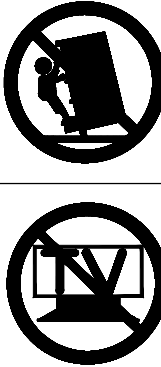

**A**

x1 Dresser  
x1 Commode  
x1 Tocador

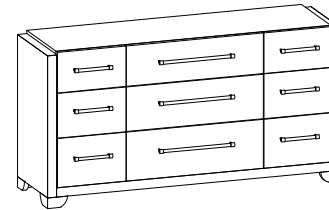
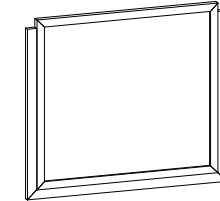

**B**

x1 Mirror  
x1 Miroir  
x1 Espejo

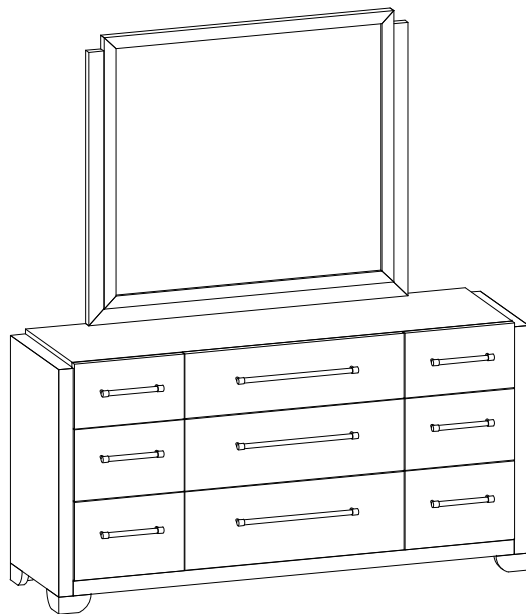

**C**

x2 Mirror Support \*  
x2 Supporte de miroir  
x2 Soporte del espejo

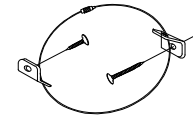

**D**

x1 Anti-tipping Restraint \*  
x1 Systeme antibasculement  
x1 Control para evitar volcos



**E**

x8 Allen Bolt Ø1/4" x 40mm \*  
x8 Vis à tête creuse hexagonale  
Ø1/4 " x 40mm  
x8 Perno Allen Ø1/4 " x 40mm



**F**

x8 Lock Washer Ø1/4" \*  
x8 Rondelle de blocage Ø1/4 "  
x8 Arandela de seguridad Ø1/4 "



**G**

x8 Flat Washer Ø1/4" \*  
x8 Rondelle de plate Ø1/4 "  
x8 Arandela plana Ø1/4 "

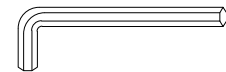

**H**

x1 Allen Key 4mm \*  
x1 Clé hexagonale 4mm  
x1 Llave allen 4mm

\* Replaceable Part

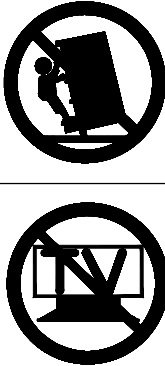
▲ AVERTISSEMENT	▲ WARNING	
<p><b>Des enfants sont morts à cause du renversement de meubles. Pour réduire le risque de renversement des meubles:</b></p> <ul style="list-style-type: none"> <li>• Installez TOUJOURS le dispositif anti- basculement fourni.</li> <li>• NE JAMAIS placer un téléviseur sur ce produit.</li> <li>• NE JAMAIS laisser un enfant se tenir debout sur les tiroirs, les portes ou les tablettes, y grimper ou s'y suspendre.</li> <li>• N'ouvrez JAMAIS ouvrir plus d'un tiroir à la fois.</li> <li>• Mettre les objets les plus lourds dans les tiroirs du bas.</li> </ul> <p style="text-align: center;"><i>Cette étiquette est permanent Ne pas la retirer !</i></p>	<p><b>Children have died from furniture tipover. To reduce the risk of furniture tipover:</b></p> <ul style="list-style-type: none"> <li>• ALWAYS install anti-tip device provided.</li> <li>• NEVER put a TV on this product.</li> <li>• NEVER allow children to stand, climb, or hang on any drawers, doors or shelves.</li> <li>• NEVER open more than one drawer at a time.</li> <li>• Place heaviest items in the lowest drawers.</li> </ul> <p style="text-align: center;"><i>This is a permanent label. Do not remove !</i></p>	

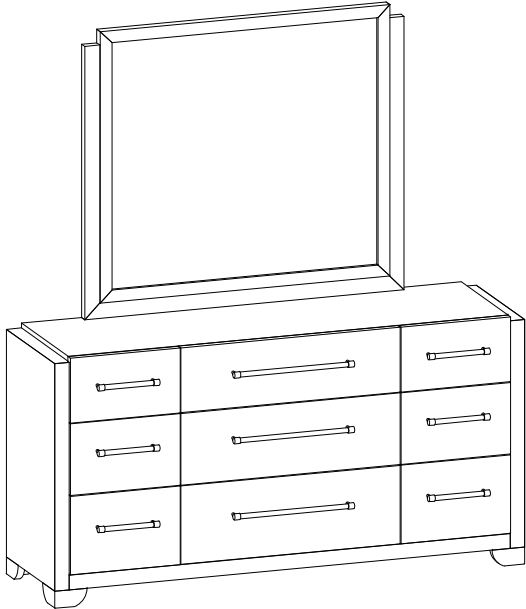

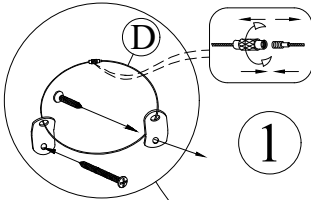

1

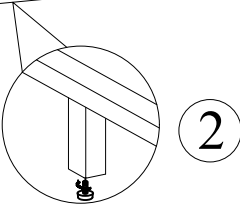

2

Leveler

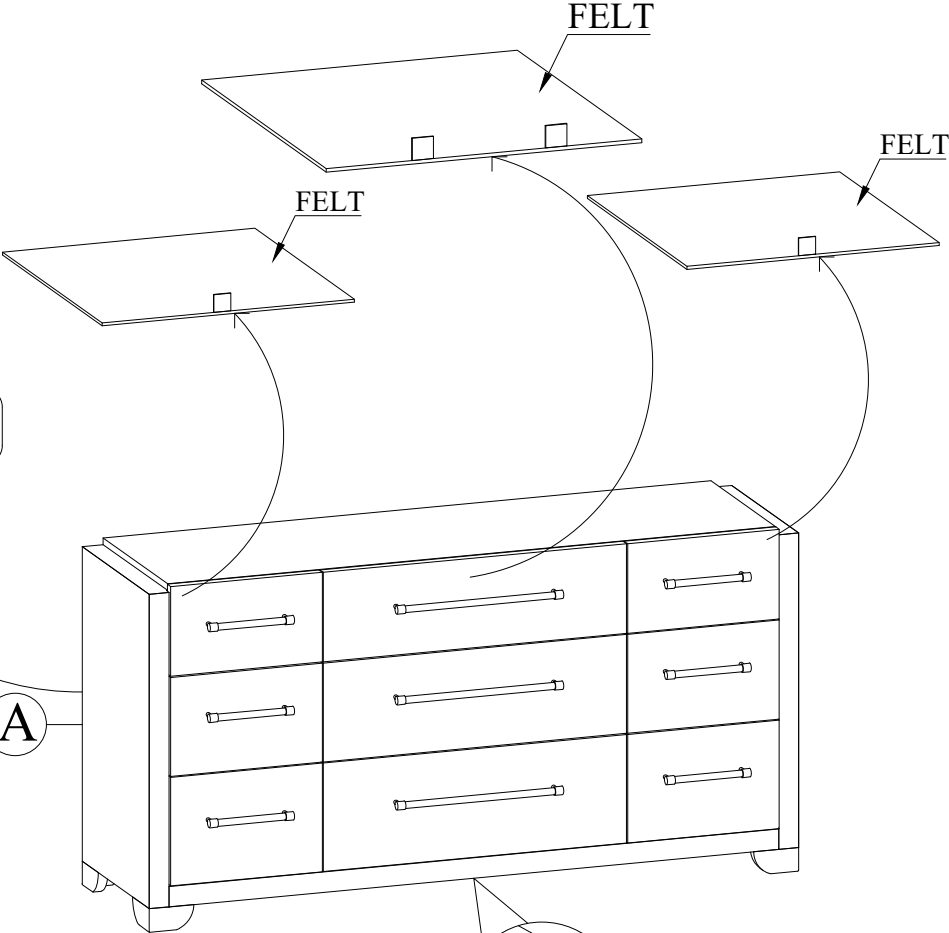

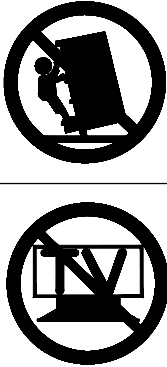
▲ AVERTISSEMENT	▲ WARNING	
<p><b>Des enfants sont morts à cause du renversement de meubles. Pour réduire le risque de renversement des meubles:</b></p> <ul style="list-style-type: none"> <li>• Installez TOUJOURS le dispositif anti- basculement fourni.</li> <li>• NE JAMAIS placer un téléviseur sur ce produit.</li> <li>• NE JAMAIS laisser un enfant se tenir debout sur les tiroirs, les portes ou les tablettes, y grimper ou s'y suspendre.</li> <li>• N'ouvrez JAMAIS ouvrir plus d'un tiroir à la fois.</li> <li>• Mettre les objets les plus lourds dans les tiroirs du bas.</li> </ul> <p><i>Cette étiquette est permanent Ne pas la retirer !</i></p>	<p><b>Children have died from furniture tipover. To reduce the risk of furniture tipover:</b></p> <ul style="list-style-type: none"> <li>• ALWAYS install anti-tip device provided.</li> <li>• NEVER put a TV on this product.</li> <li>• NEVER allow children to stand, climb, or hang on any drawers, doors or shelves.</li> <li>• NEVER open more than one drawer at a time.</li> <li>• Place heaviest items in the lowest drawers.</li> </ul> <p><i>This is a permanent label. Do not remove !</i></p>	

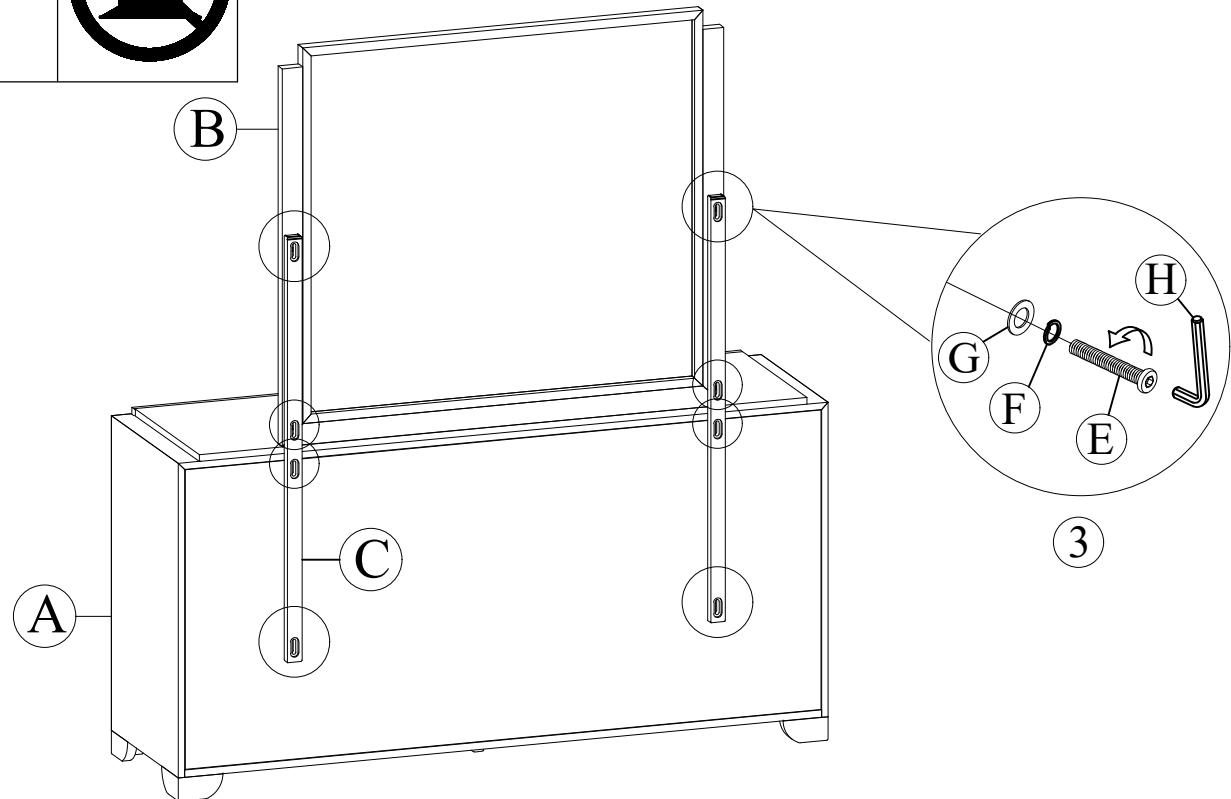
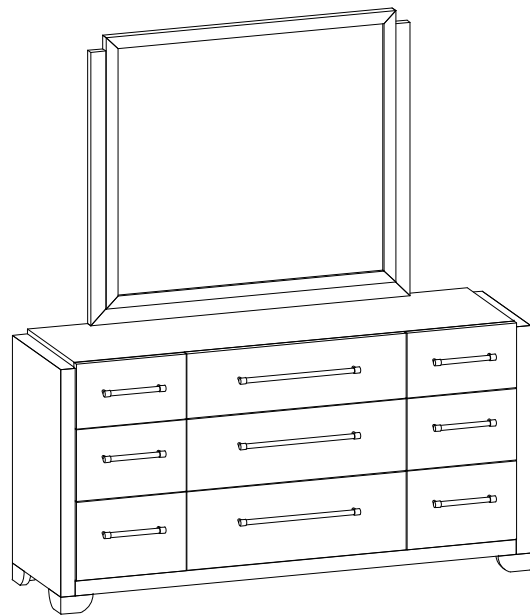

## ▲ AVERTISSEMENT

**Des enfants sont morts à cause du renversement de meubles. Pour réduire le risque de renversement des meubles:**

- Installez TOUJOURS le dispositif anti-basculement fourni.
- NE JAMAIS placer un téléviseur sur ce produit.
- NE JAMAIS laisser un enfant se tenir debout sur les tiroirs, les portes ou les tablettes, y grimper ou s'y suspendre.
- N'ouvrez JAMAIS ouvrir plus d'un tiroir à la fois.
- Mettre les objets les plus lourds dans les tiroirs du bas.

*Cette étiquette est permanent  
Ne pas la retirer !*

## ▲ WARNING

**Children have died from furniture tipover. To reduce the risk of furniture tipover:**

- ALWAYS install anti-tip device provided.
- NEVER put a TV on this product.
- NEVER allow children to stand, climb, or hang on any drawers, doors or shelves.
- NEVER open more than one drawer at a time.
- Place heaviest items in the lowest drawers.

*This is a permanent label.  
Do not remove !*

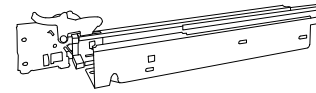
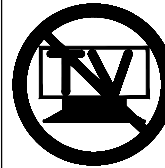

x9 RP402100-GLIDE  
Undermount Soft Close  
Fermeture douce sous-montée  
Cierre suave con montaje inferior



x2 RP402100-SFELT  
Side Removable Felt  
Feutre  
Fieltro

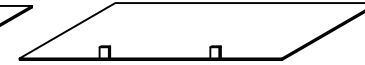

x1 RP402100-CEFELT  
Center Removable Felt  
Feutre  
Fieltro

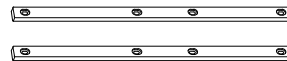
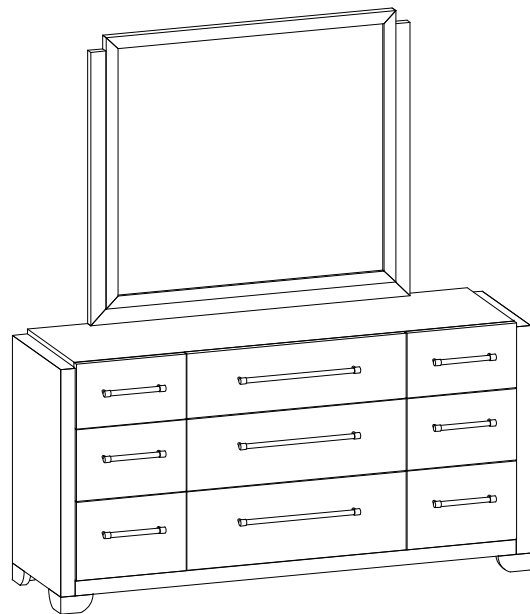

x2 RP402-110-MISU  
Mirror Support  
Supporte de miroir  
Soporte del espejo



x6 RCP402-SHANDLE  
Short Handle With Screw  
Poignée Courte Avec Vis  
Manija Corta Con Tornillo



x3 RCP402-LHANDLE  
Long Handle With Screw  
Poignée Longue Avec Vis  
Manija Larga Con Tornillo

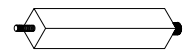

x1 RP402100-CELEG  
Center Leg  
Support central  
Soporte para la pata central

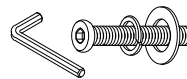

x1 RP402-110-HWKIT  
Hardware Kit  
Kit de matériel  
Kit de hardware



x2 RC-LEVE-White  
White Leveler  
Patin réglable  
Nivelador



x2 RC-WH-NAIL  
White Plastic Nail  
Clou en plastique  
Clavo de plástico

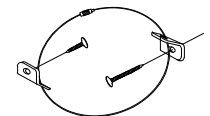

x1 RC-ANTI-TIP-M  
Anti-tipping Restraint  
Système antibasculement  
Control para evitar vulcos

\* Replaceable Part