

READ AND SAVE THIS INSTRUCTIONS FOR FUTURE USE

Tools Recommended

# ASSEMBLY & INSTRUCTION MANUAL

**WARNING****EN**

1. A 3 person assembly is required for this tent.
2. Please take appropriate actions as heavy rain, wind and snow can damage the tent. If necessary please dis-assemble and store for later use.
3. In snowy conditions please do not allow the thickness of the snow to be more than 5cm on the roof, this should be cleared as soon as possible for your safety.

**ATTENTION****FR**

1. 3 personnes minimum requis pour le montage de la tente.
2. Ne pas utiliser la tente en période de pluie, de vent et de neige qui peuvent endommager la tente. Nous ne serons pas responsable de la mauvaise utilisation du produit.
3. Pour votre sécurité, en période de neige, il est recommandé de ne pas laisser de neige de plus de 5cm sur le toit.

**ADVERTENCIA****ES**

1. Se requieren 3 personas para realizar el montaje de esta tienda de campaña.
2. Tome las medidas apropiadas, ya que las fuertes lluvias, viento y nieve pueden dañar la tienda de campaña. Si es necesario, desarme y almacene la tienda de campaña para el uso posterior.
3. En condiciones de nieve, no permita que el grosor de la nieve sea superior a 5 cm en el techo, en el motivo de proteger su seguridad, debe eliminar la nieve en techo lo más pronto posible.



























**WARNHINWEISE****DE**

1. Bauen Sie das Zelt mit Hilfe von 3 Personen auf.
2. Stellen Sie das Zelt auf einen ebenen Untergrund auf und achten Sie darauf, dass sich keine offenen Feuerstellen in der Nähe befinden.
3. Um Beschädigungen des Zeltes zu vermeiden, benutzen Sie es bitte nicht bei schlechten Wetterbedingungen wie starkem Regen, Wind oder Schneefällen. Für Schäden aufgrund schlechter Witterungsverhältnisse wird keine Haftung und Gewährleistung übernommen.
4. Bei Schneefall darf die Schneehöhe auf dem Dach 5 cm nicht überschreiten. Es obliegt Ihrer Verantwortung, das Zelt rechtzeitig und vorsichtig von der Schneelast zu befreien.
5. Sollten sich bei starkem Regen Wassertaschen auf dem Dach bilden, obliegt es Ihrer Verantwortung diese rechtzeitig und vorsichtig zu beseitigen.
6. Achten Sie beim Verstauen des Zeltes darauf alle Teile, insbesondere die Plane, vorher zu säubern und erst in trockenem Zustand einzupacken. Lagern Sie das Zelt an einem trockenen Ort.
7. Prüfen Sie vor Wiederaufbau des Zeltes die Vollständigkeit und Funktionalität aller für den Aufbau benötigten Teile.

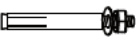

**AVVERTENZE****IT**

1. Per assemblare questa tenda sono necessarie 3 persone
2. Si prega di prendere le precauzioni necessaria in quanto pioggia, vento e neve possono danneggiare la tenda. Se necessario si prega di smontarla e conservarla per uso futuro.
3. Qualora nevicasse si prega di non lasciare che lo strato di neve sopra la tenda sia spesso oltre i 5cm, anzi la neve va rimossa al più' presto per la vostra sicurezza.

BOX 1/2

No.	PARTS	Qty
A		4pcs
B		4pcs
C		4pcs
D		4pcs
E		4pcs
F		4pcs
G		4pcs
H		8pcs
I		4pcs
J		4pcs
K		6pcs
L		2pcs
M		2pcs
N		8pcs
O		1pc
P		1pc
Q		6pcs
R		4pcs
S		4pcs
T		4pcs
U		16pcs
V		1pc
W		4pcs
X1	 M6*15	91pcs
X2	 M6*40	32pcs
X3		8pcs
Y		123pcs
Z		1pc

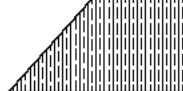
BOX 2/2

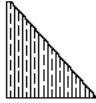
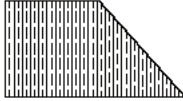
No.	PARTS	Qty
1		4pcs
2		4pcs
3		4pcs
4		4pcs
5		4pcs

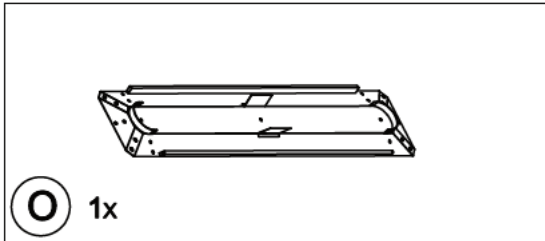
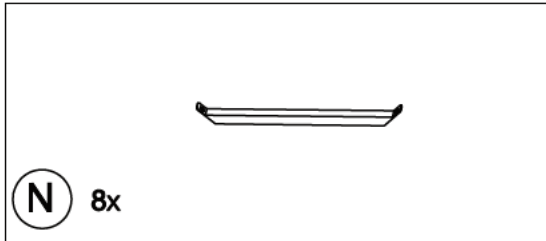
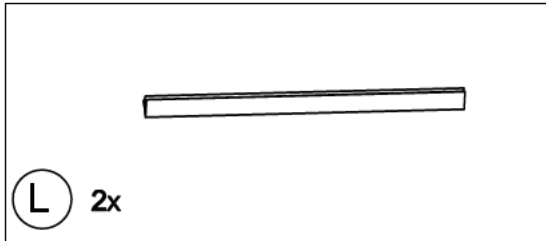
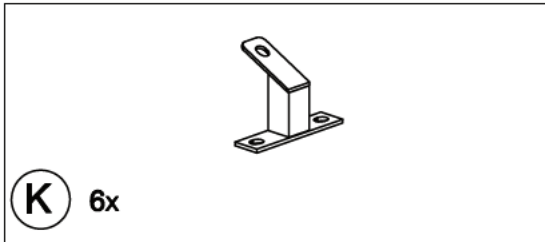
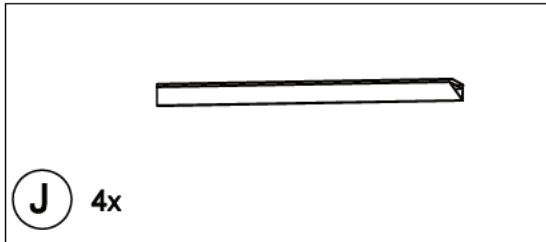
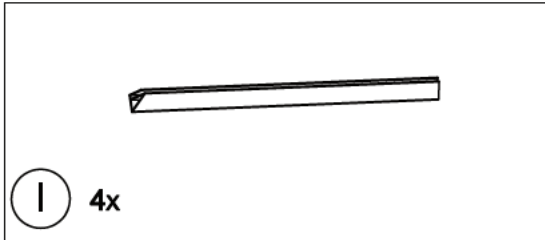
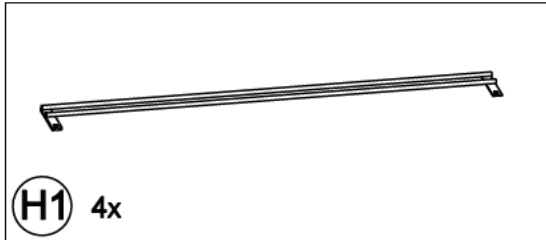
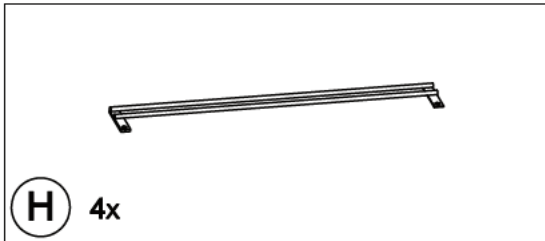
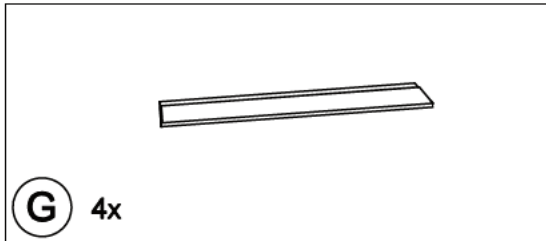
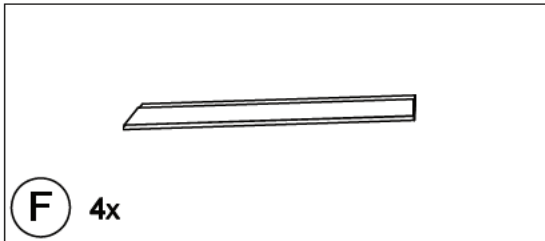
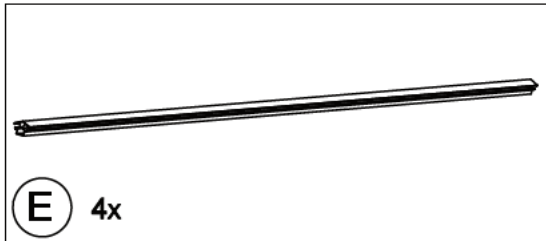
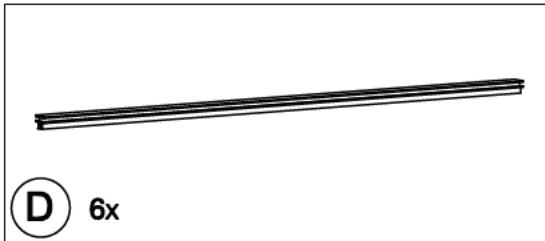
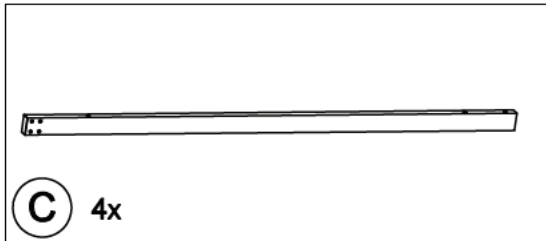
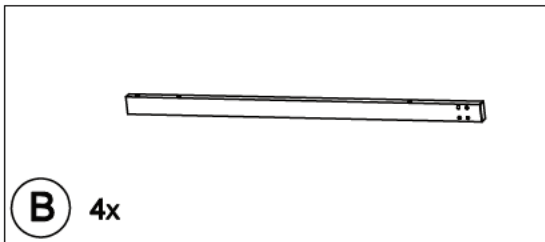
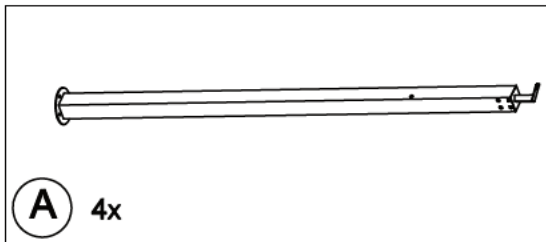

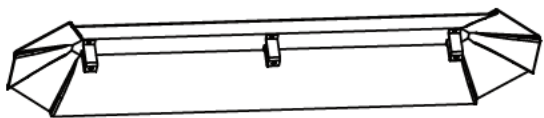

**P** 1x



**Q** 6x



**R** 4x



**S** 4x



**T** 4x



**U** 16x



**V** 1x

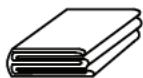

**W** 4x



M6\*15

**X1** 91x



M6\*40

**X2** 32x

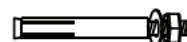

**X3** 8x



**Y** 123x



**Z** 1x

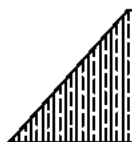

**1** 4x

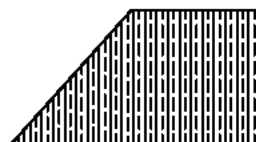

**2** 4x

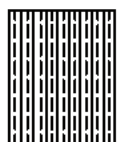

**3** 4x

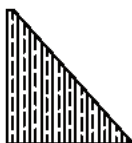

**4** 4x

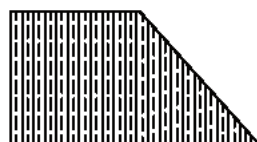

**5** 4x



**A** 4x



**B** 4x

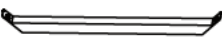

**N** 4x



M6\*15

**X1** 8x

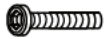

M6\*40

**X2** 16x



**Y** 24x

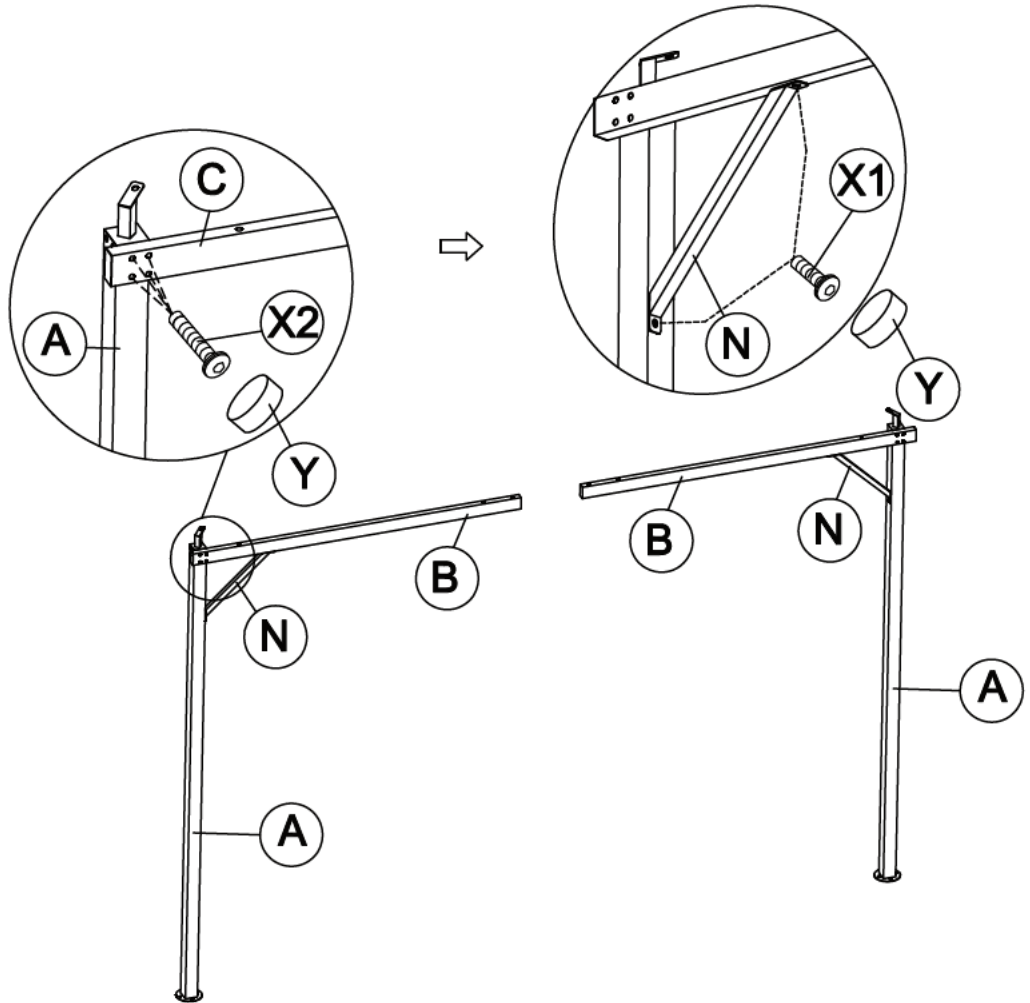



**H** 4x



**K** 2x



**T** 2x



**X1** 12x  
M6\*15



**Y** 12x

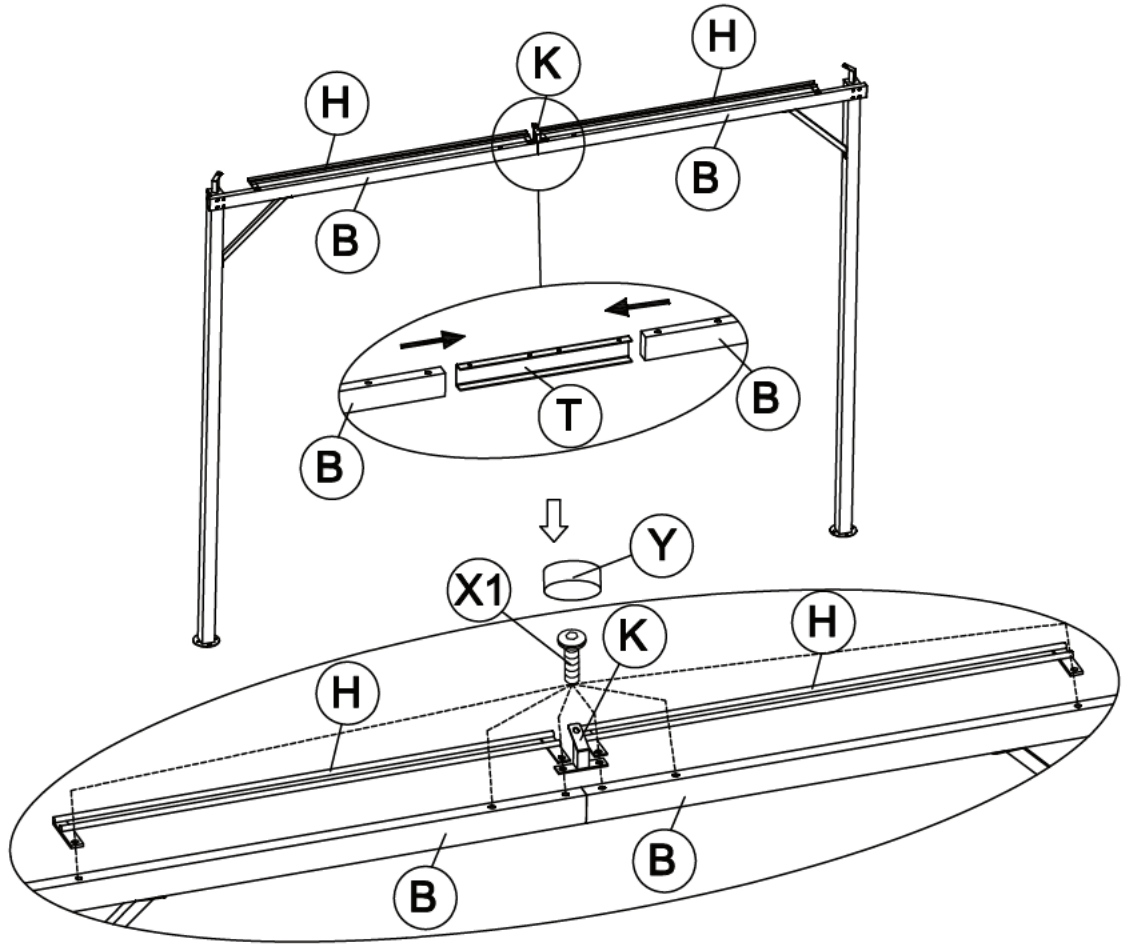



**C** 4x



**N** 4x



M6\*15

**X1** 8x



M6\*40

**X2** 16x



**Y** 24x

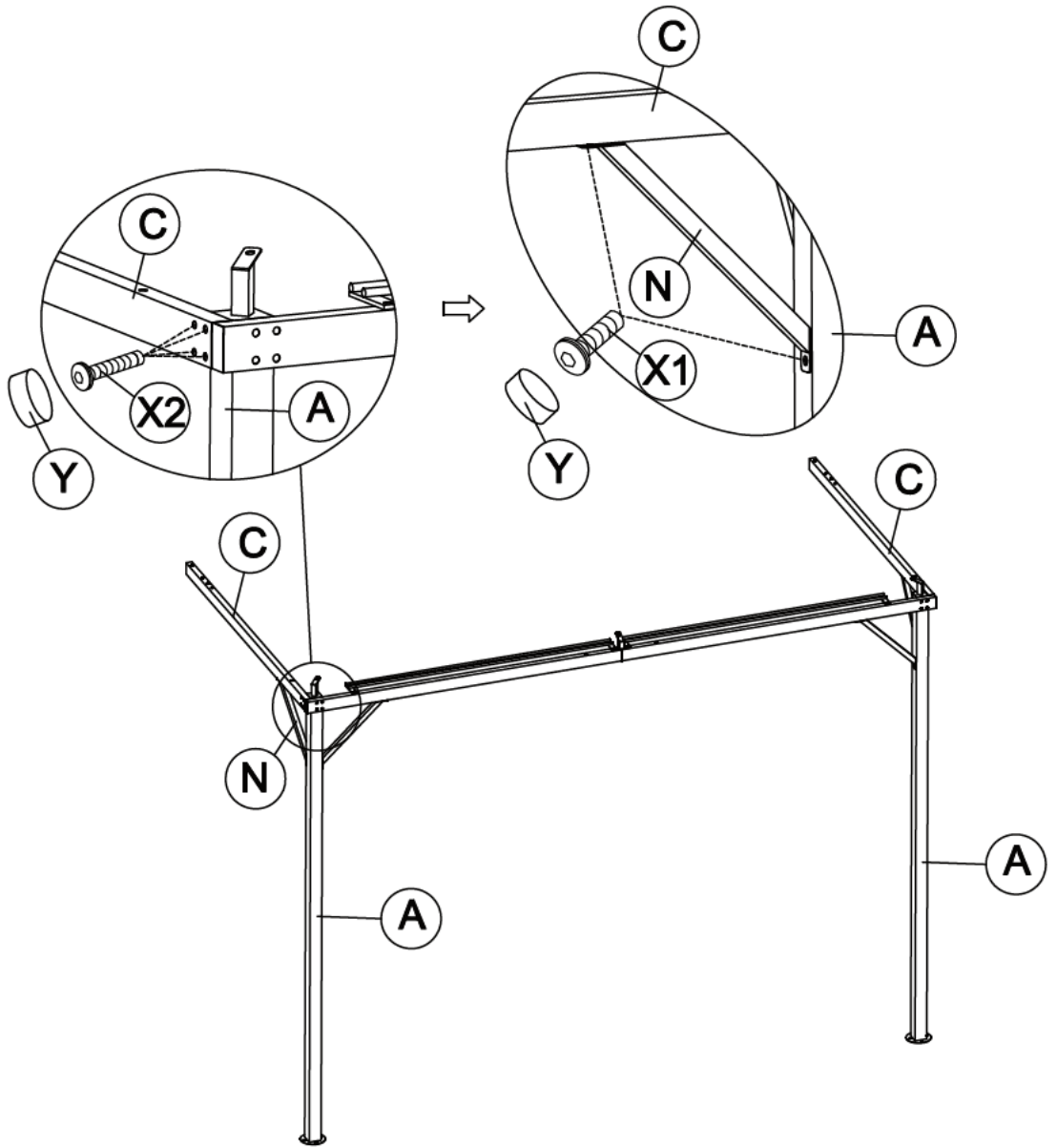



**H1** 4x



**K** 4x



**T** 2x



M6\*15

**X1** 20x



**Y** 20x

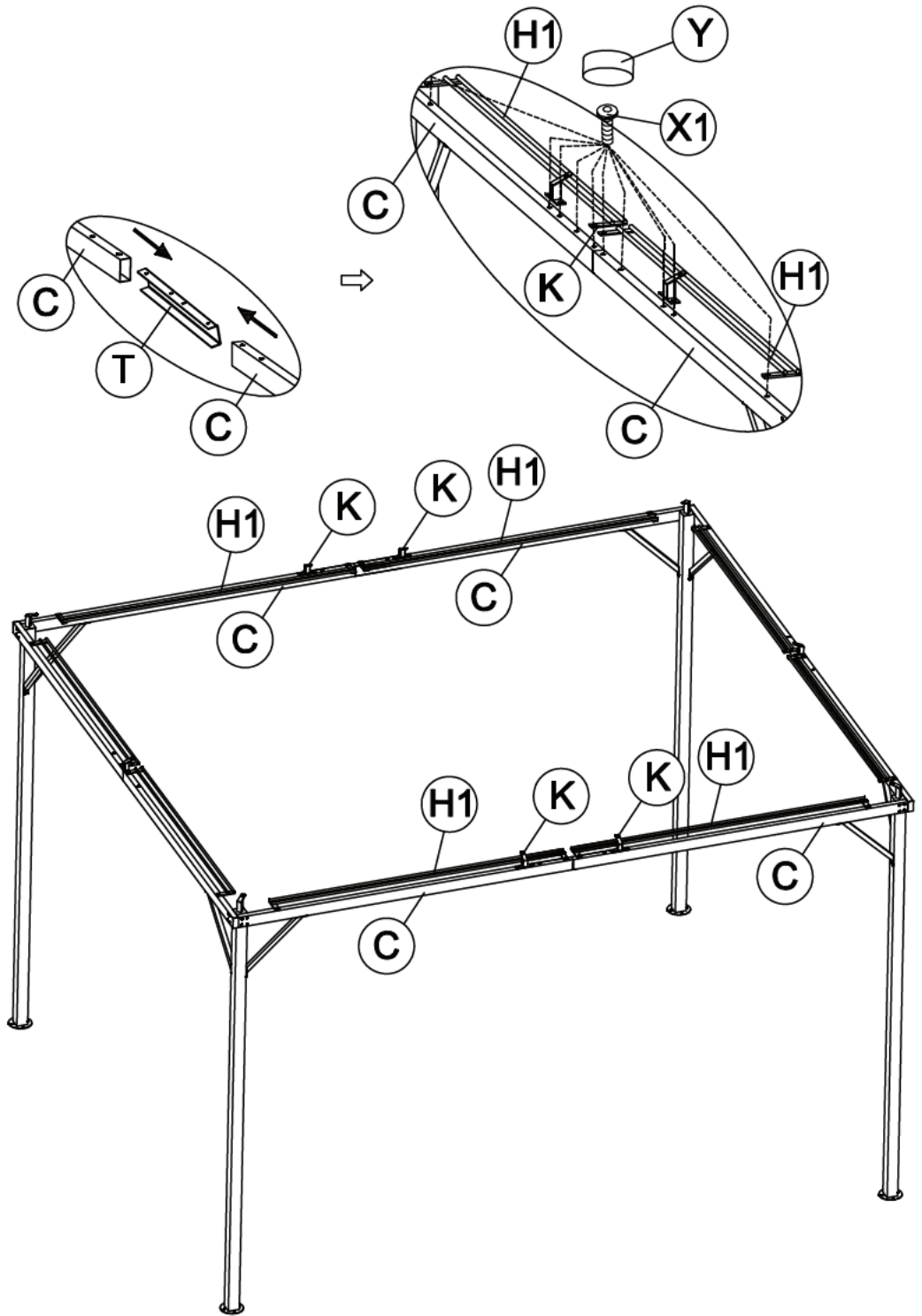



E 4x



O 1x



X1 8x



Y 8x

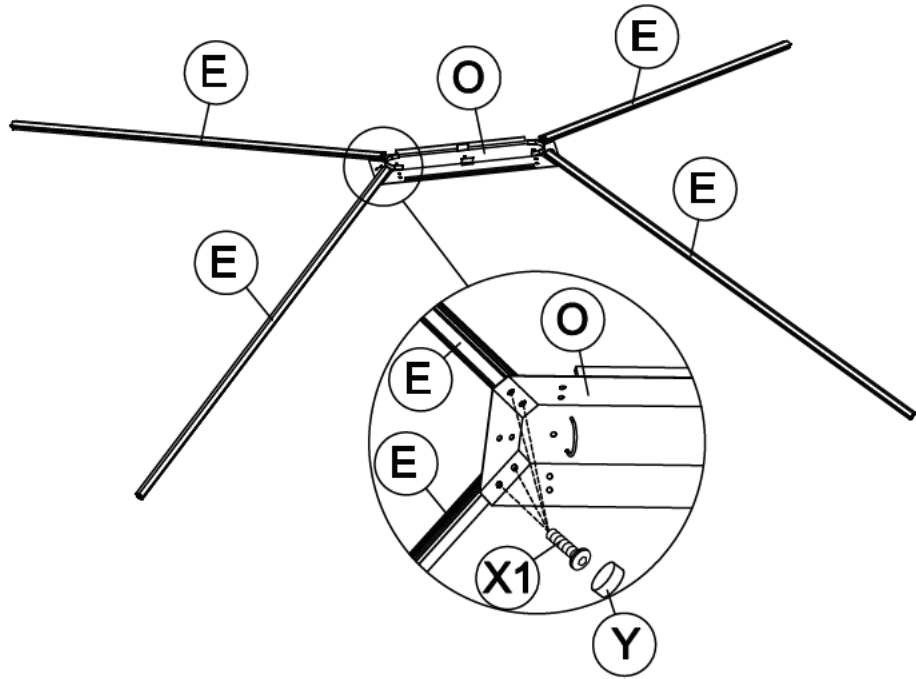

X1 4x



Y 4x

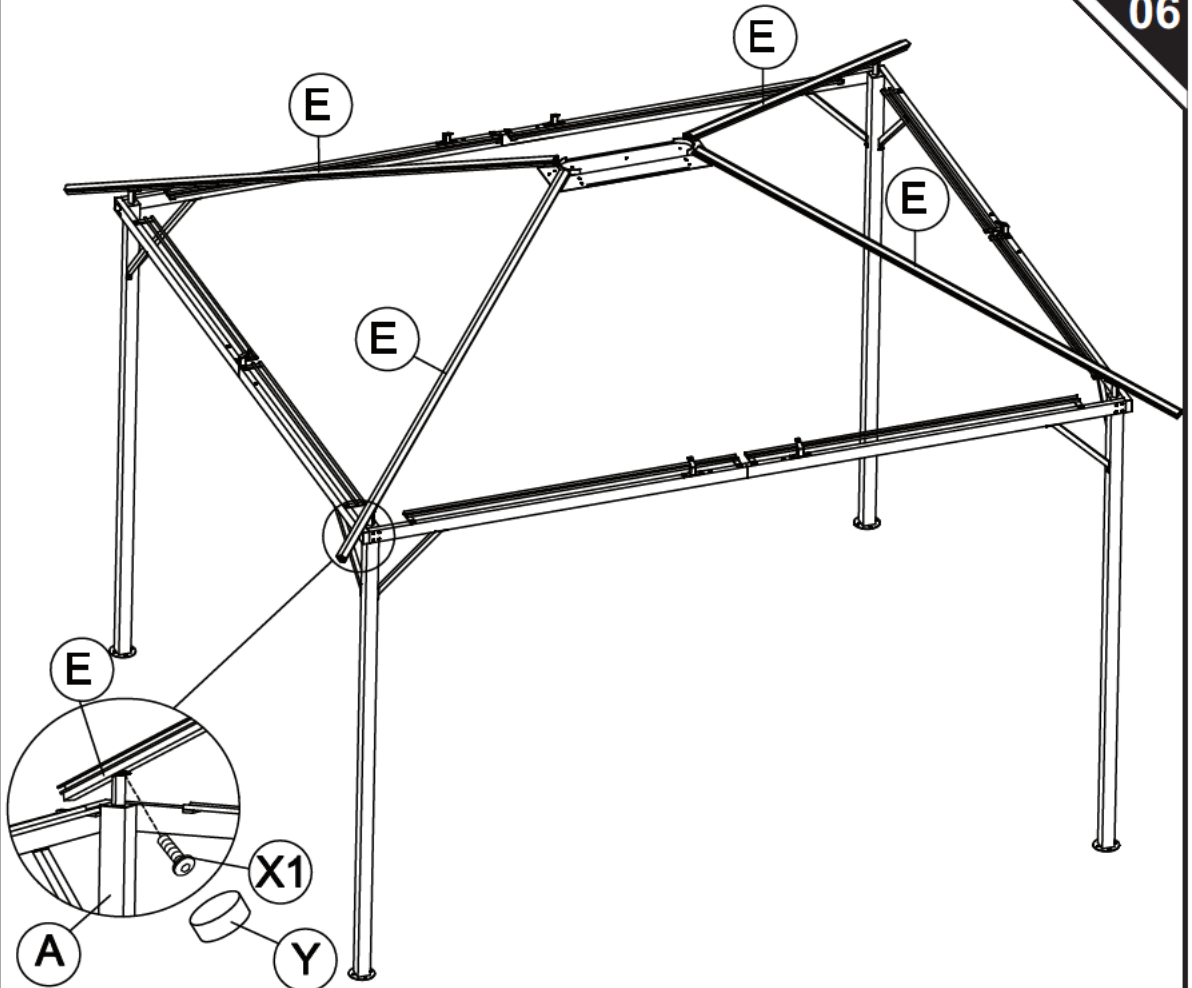



D 6x



X1 18x



Y 18x

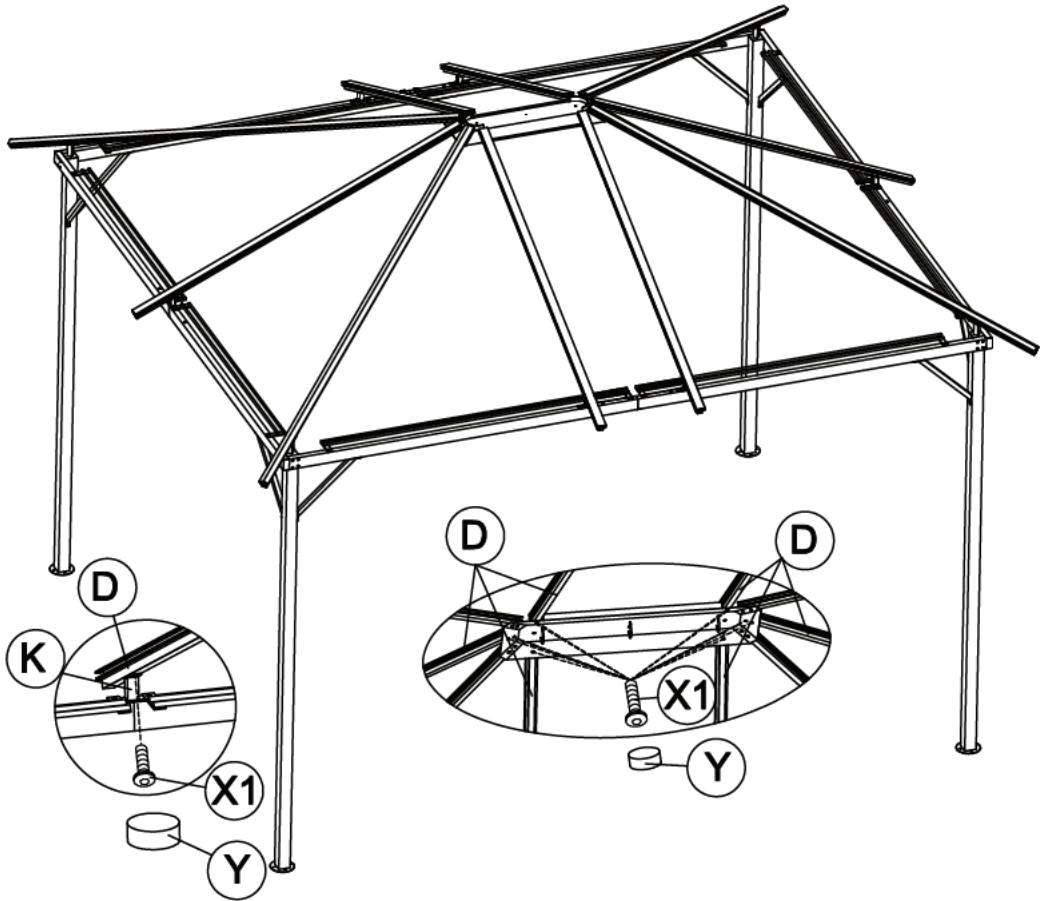

P 1x









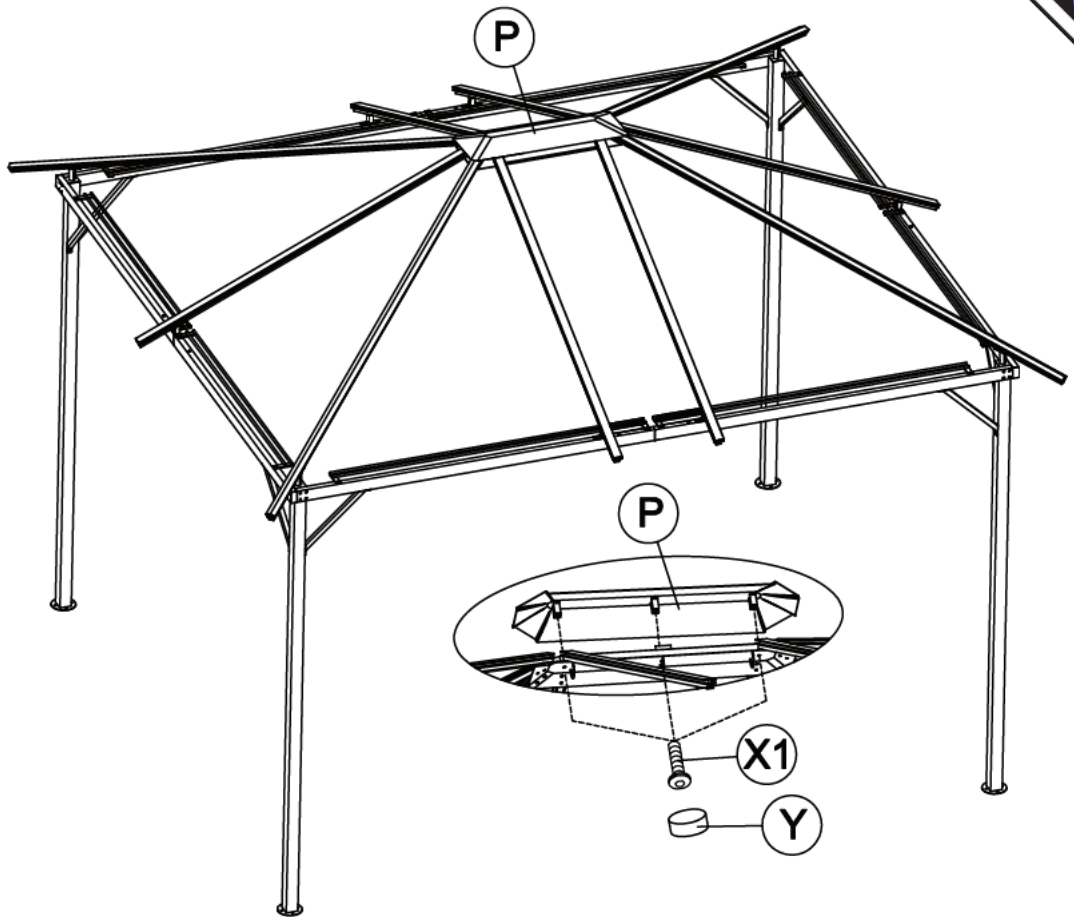

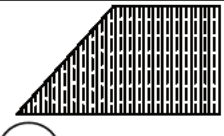
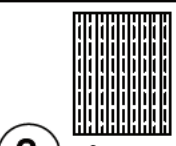
X1 3x

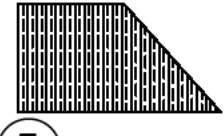

Y 3x

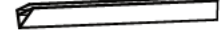

-  1 4x
-  2 4x
-  3 4x
-  4 4x
-  5 4x
-  F 4x
-  G 4x
-  M 2x
-  I 4x
-  J 4x

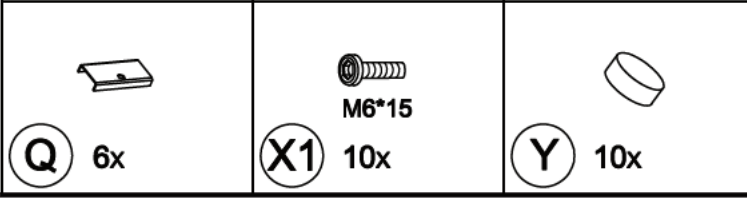
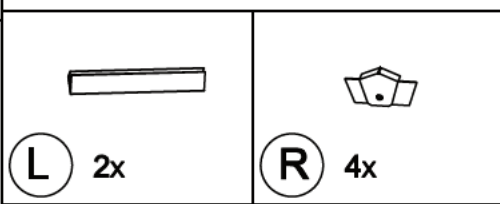
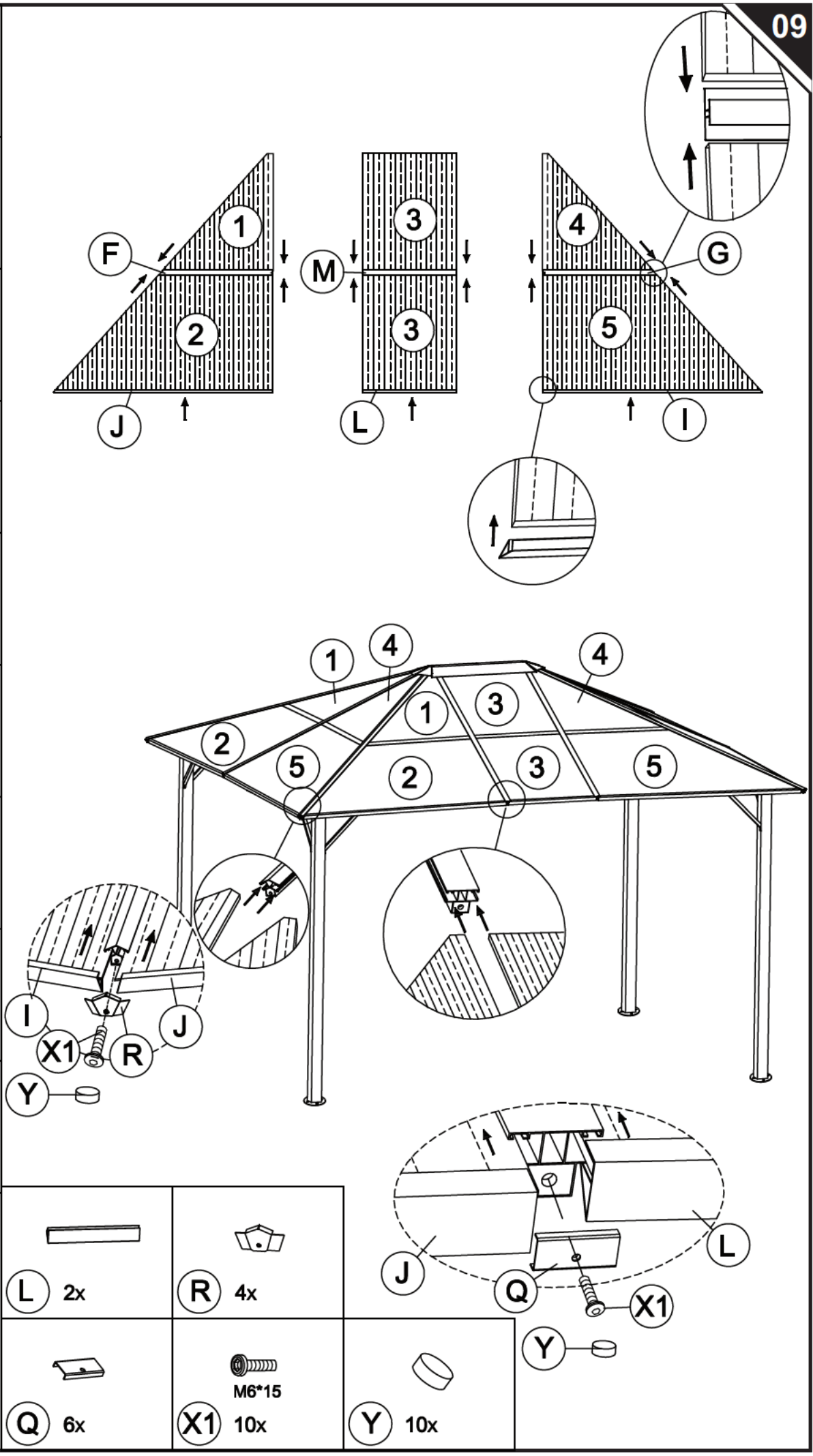

Done

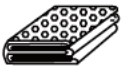

S 4x

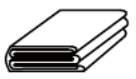

W 4x



U 16x

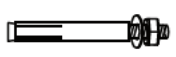

X3 8x

