

Assembly Instructions

TOOLS REQUIRED BUT NOT INCLUDED:
EX. 'Phillips head screwdriver, Level, Hammer'

WARNINGS:
Do not throw away packing materials and carton until after assembly.
Assemble all parts on a clean smooth surface.

CARE INSTRUCTIONS:
Avoid direct exposure to sunlight. Do not place over heat or air conditioning vents.
Adjust levelers so that the furniture sits flat on uneven floors.
Blot spills do not rub, with a clean white cloth.
Do not use harsh chemicals.
Before cleaning any part test a small spot in a hidden area.
You may need to re-tighten all bolts after initial use.

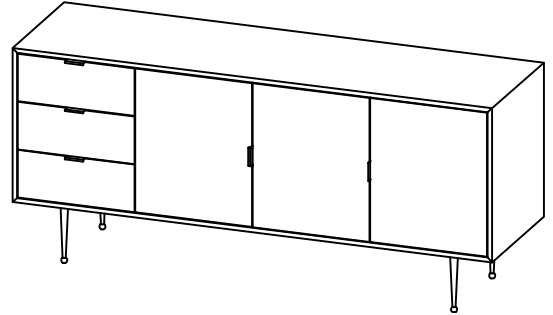

PARTS INCLUDED

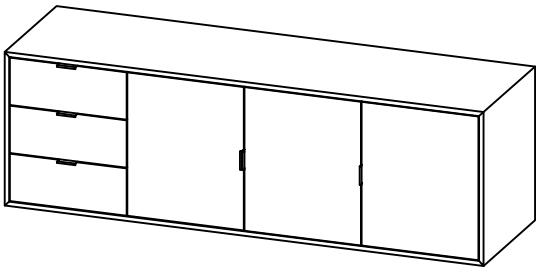

(A) TOP PART
x1



(B) LEG
x4

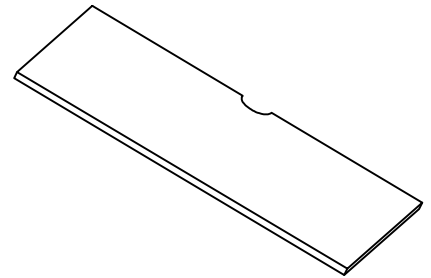

(C) LARGE SHELF
x1

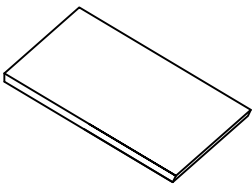

(D) SMALL SHELF
x1

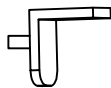

(E) SHELF PIN
X8



(F) CSK ALLEN BOLT
[M6 X 16 MM]
16x



(G) ALLEN KEY [4MM]
1x

Assembly Instructions

STEP1: With help lay the Top Part (A) over into a clean smooth surface. Attach Leg (B) on the Bottom of Buffet by using Bolts (F) and tighten with Allen Key (G) as shown in below).

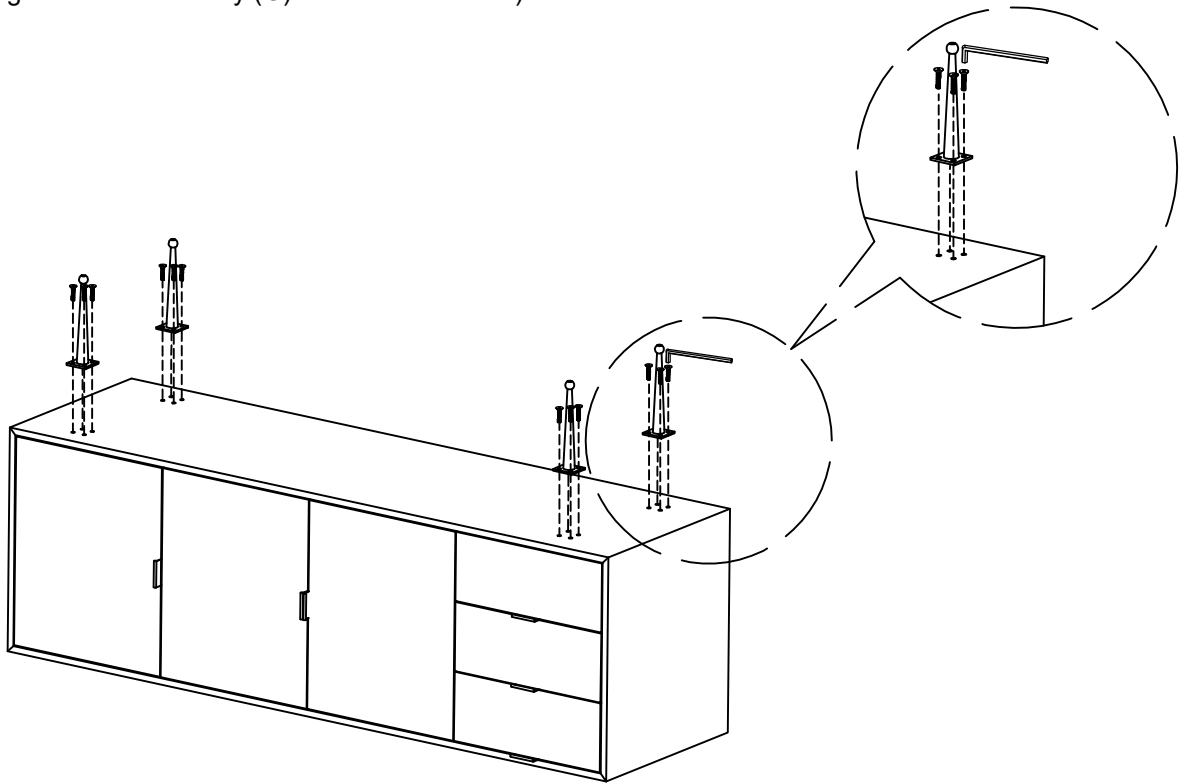

STEP 2: Place shelf pin (E) on to the holes.

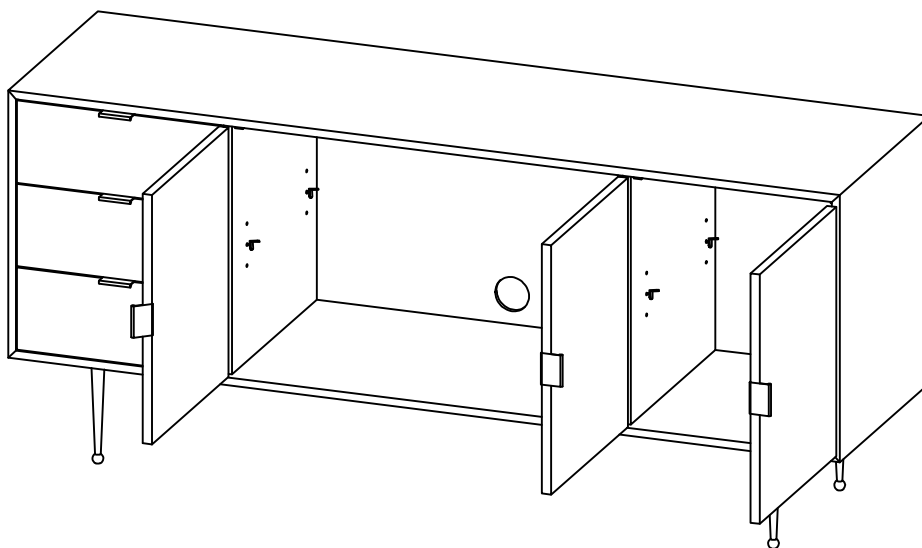

Assembly Instructions

STEP 3: Then place the Large shelf (C) & Small shelf (D) on to the shelf pin (E).

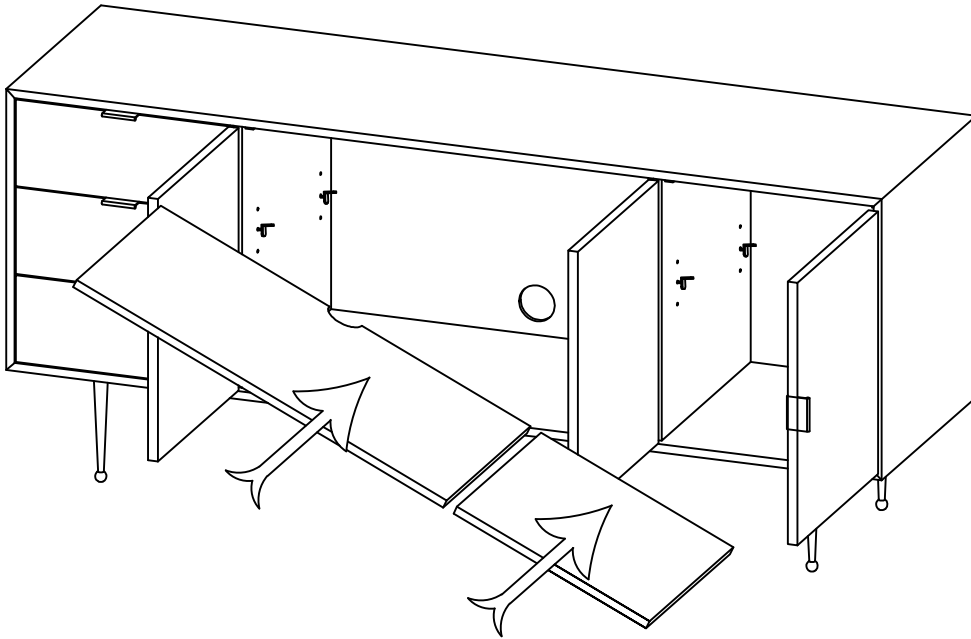

FINAL: Now Your Buffet is ready for use.

