

ASSEMBLY INSTRUCTION

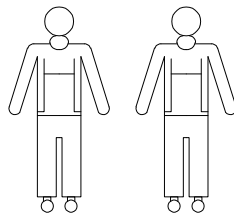

Minimum no. 2 of people
recommended to assemble
this product: Approx.
assembly time: 60 mins

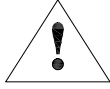



SAFETY WARNING









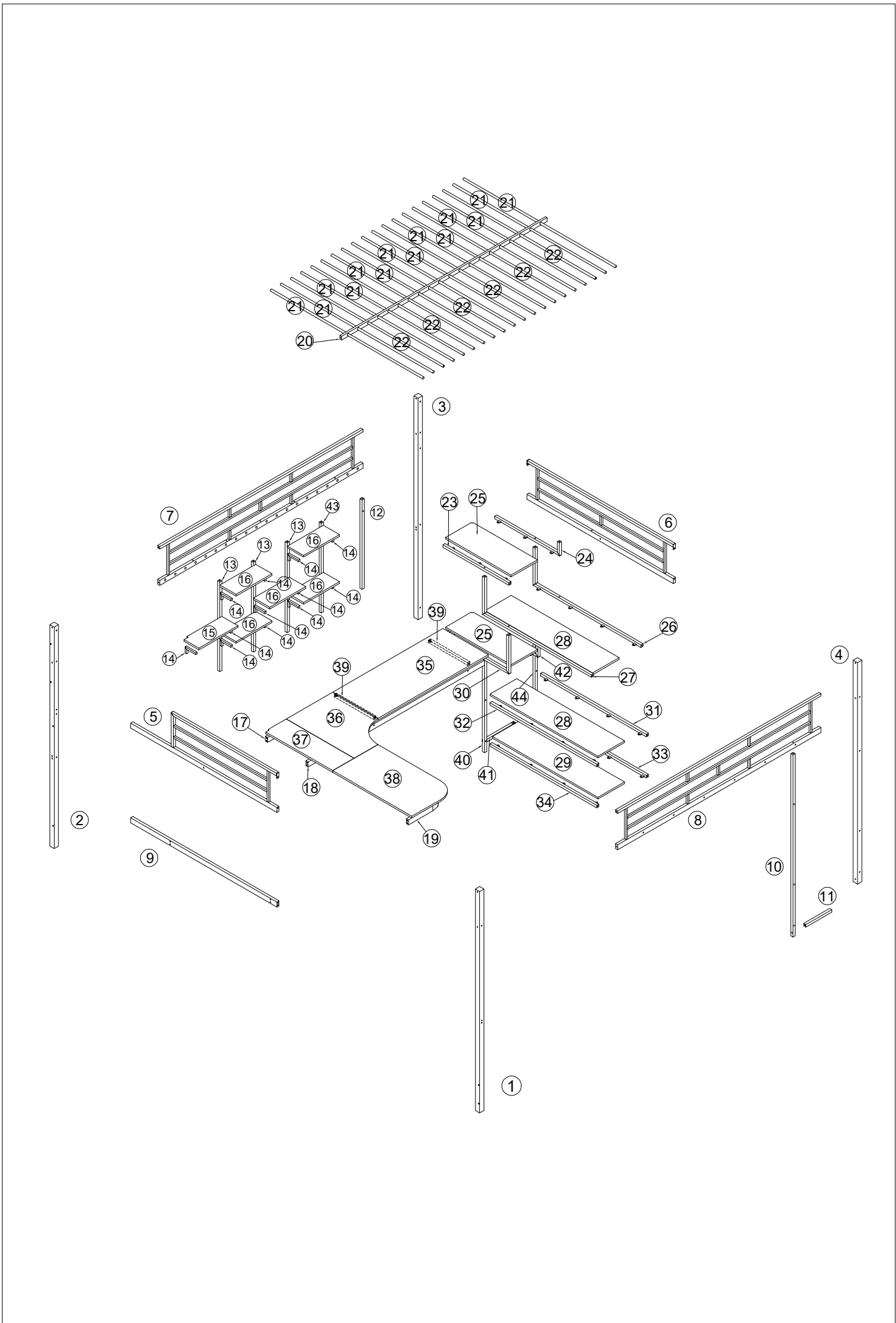







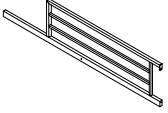
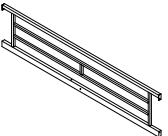
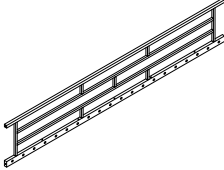
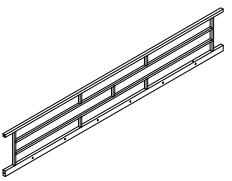
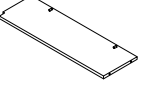

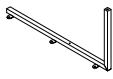



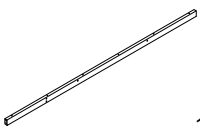
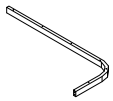

1. This bed is designed for use only mattress(es) meeting the following specifications on the upper bunk
Upper bunk

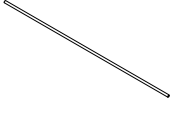
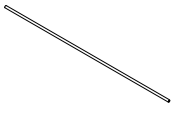
Bed type	Length	Width	Thickness
Full Standard	74"- 75"	53"- 54"	6" Max

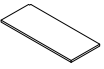



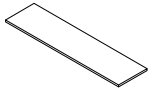



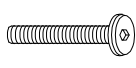
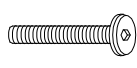
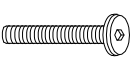
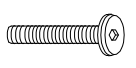
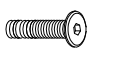

2. Follow the Information on the warnings appearing on the upper bunk bed end structure and on the carton. Do not remove warning label from bed.
3. Always use the recommended size mattresses or mattress supports, or both, to help prevent the likelihood of entrapment or falls.
4. Surface of mattress must be at least 5" (127mm) below the upper edge of guardrails .
5. Do not allow children under 6 years of age to use the upper bunk.
6. Periodically check and ensure that the guardrail , ladder , and other components are in their proper position , free from damage , and that all connectors are tight .
7. Do not allow horseplay on or under the bed and prohibit Jumping on the bed .
8. Always use the ladder for entering and leaving the upper bunk .
9. Do not use substitute part . Contact the manufacturer or dealer for replacement part .
10. Use of a night light may provide added safety precaution for a child using the upper bunk .
11. Always use guardrails on both long sides of upper bunk . If the bunk bed will be placed next to the wall , the guardrail that runs the full length of the bed should be placed against the wall to prevent entrapment between the bed and wall .
12. The use of water or sleep flotation mattresses is prohibited .
13. STRANGULATION HAZARD - Never attach or hang items to any part of the bunk bed that are not designed for use with the bed ; for example , but not limited to , hook , belts and Jump ropes .
14. Keep these Instructions for future reference .
15. Prohibit more than one person on upper bunk
16. We recommend assembling your bunk bed on the shipping carton to protect your floor or carpet
17. Be certain all staples are out the box before beginning assembly on the shipping carton .









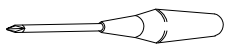



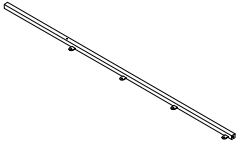
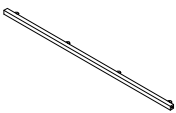
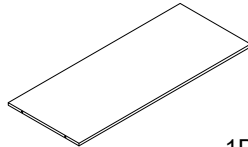
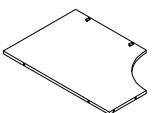
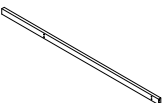
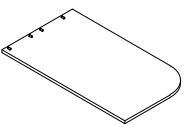







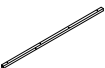





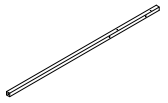
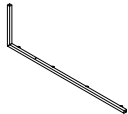

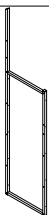

PART LIST

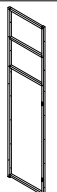
1  1PC	2  1PC	3  1PC	4  1PC
5  1PC	6  1PC	7  1PC	8  1PC
37  1PC	40  1PC	42  1PC	12  1PC
13  3PCS	14  12PCS	43  1PC	16  2PCS
17  1PC	18  1PC	19  1PC	20  1PC
21  14PCS	22  6PCS	46  1PC	50  1PC
25  2PCS	26  1PC	54  1PC	65  1PC
29  1PC	30  1PC		

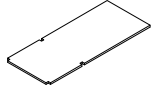
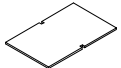
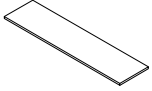
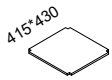

HARDWARE LIST

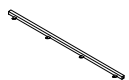
A  38PCS M $\frac{1}{2}$ "X55	B  2PCS M $\frac{1}{2}$ "X50	C  69PCS M $\frac{1}{4}$ "X35	D  22PCS M $\frac{1}{4}$ "X30	E  25PCS M $\frac{1}{4}$ "X15
F  4PCS #40x40x16	G  16PCS M4x50	H  54PCS M4x30	i  22PCS M4x25	j  45PCS M4x15
K  10PCS #20x20x13	L  2PCS 20x20	M  8PCS Ø8x25	N  1PC M4X23X57	O  Not include

PART LIST



33	 1PC	34	 1PC	35	 1PC	36	 1PC
9	 1PC	38	 1PC	39	 2PC	10	 1PC
41	 1PC	11	 1PC	15	 1PC	44	 1PC
45	 1PC	23	 1PC	47	 2PCS	48	 1PC
49	 1PC	24	 1PC	51	 1PC	52	 1PC
53	 1PC	27	 1PC	55	 1PC	56	 1PC
57	 2PCS	58	 2PCS	59	 1PC	60	 1PC
61	 1PC	62	 1PC	63	 1PC	64	 1PC
28	 2PCS	66	 1PC	67	 1PC	68	 2PCS
69	 1PC	16	 3PCS	31	 1PC	32	 1PC

STEP 1

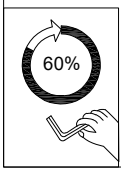
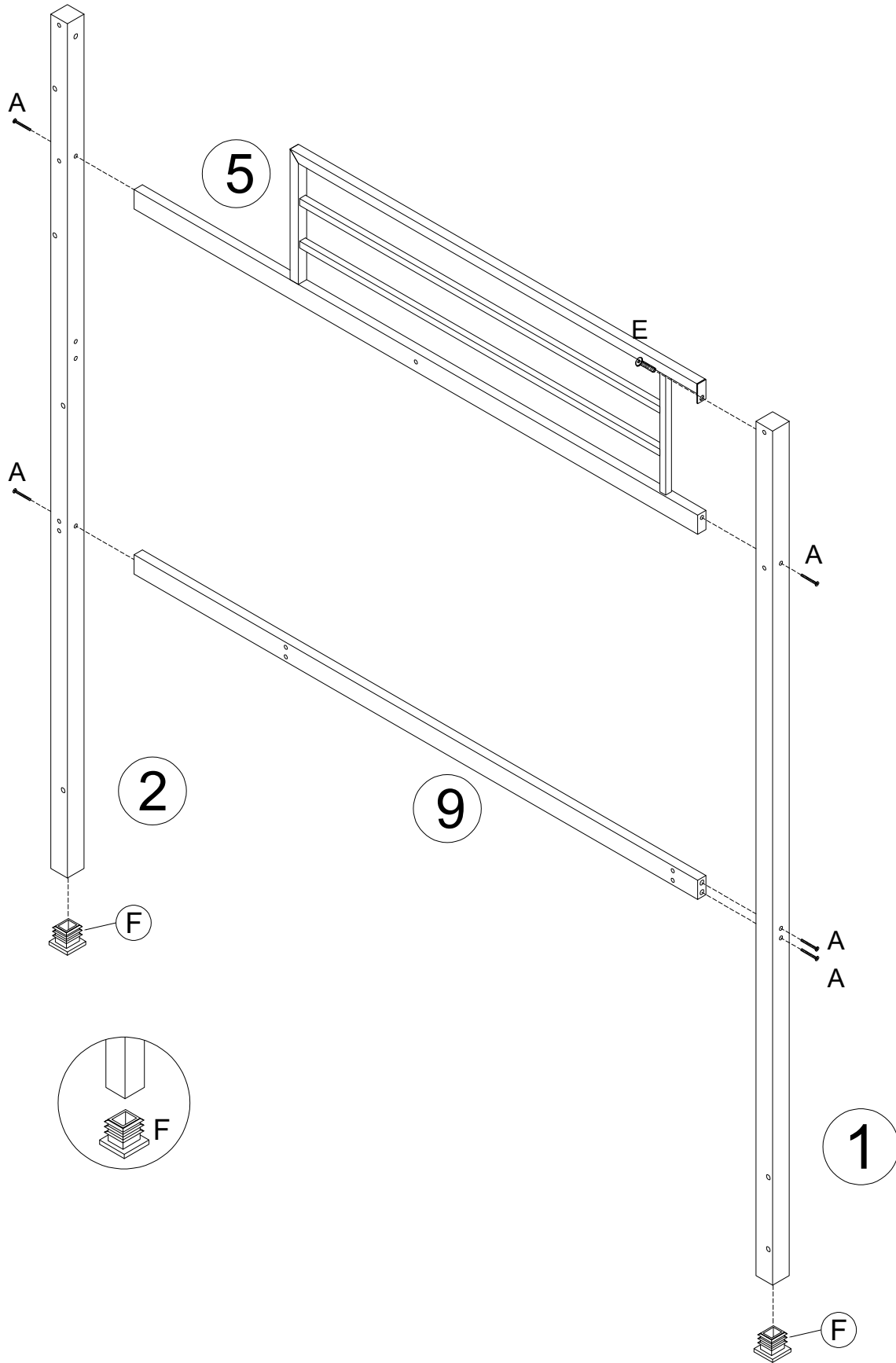
A	E	F
 M $\frac{1}{4}$ "x55	 M $\frac{1}{4}$ "x15	 #40x40x16
5 PCS	1 PC	2 PCS



STEP 2

A	E	F
 M $\frac{1}{4}$ "x55	 M $\frac{1}{4}$ "x15	 #40x40x16
4 PCS	2 PCS	2 PCS

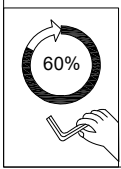
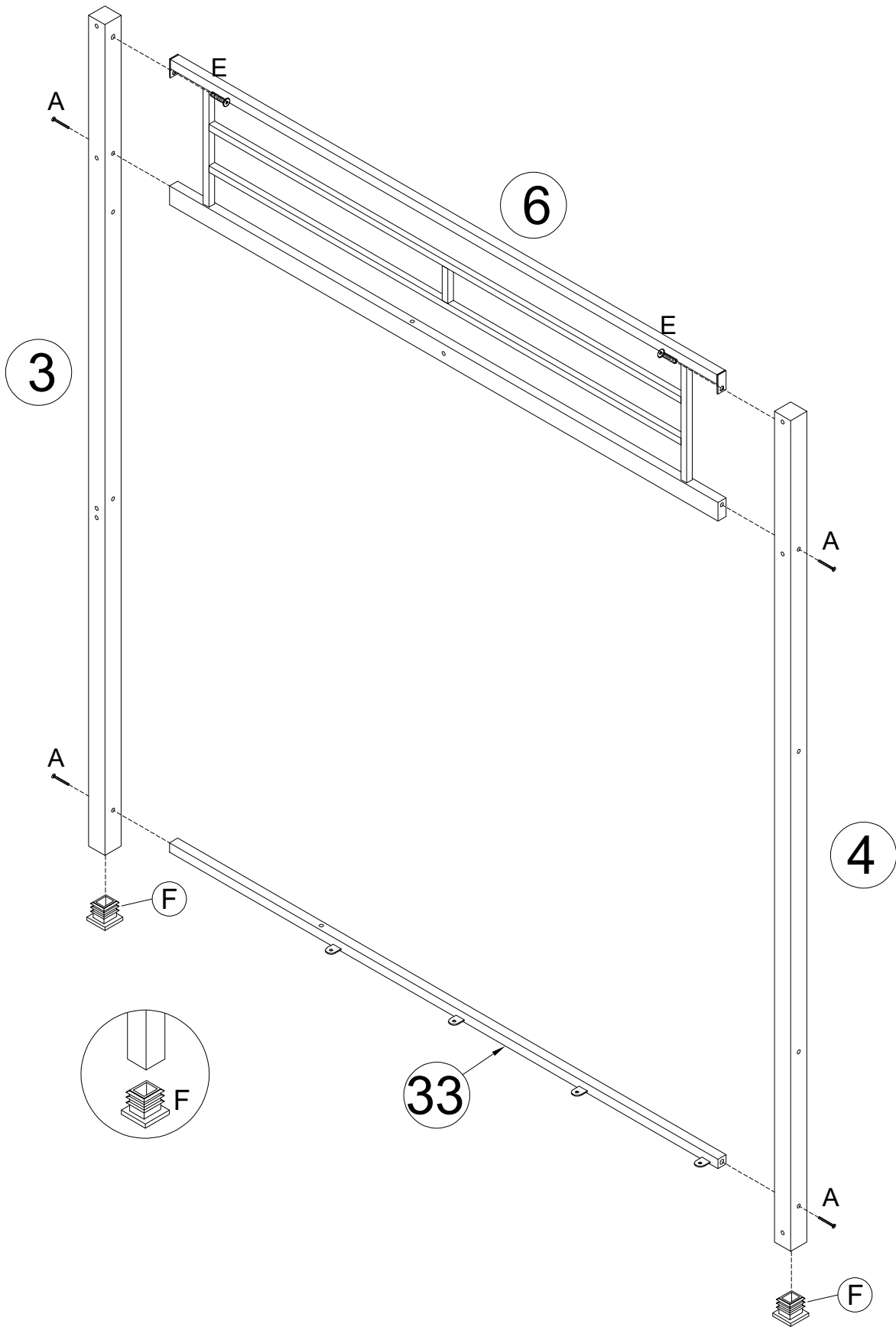

STEP 3



E

M $\frac{1}{4}$ x15

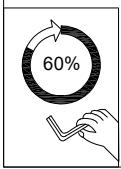
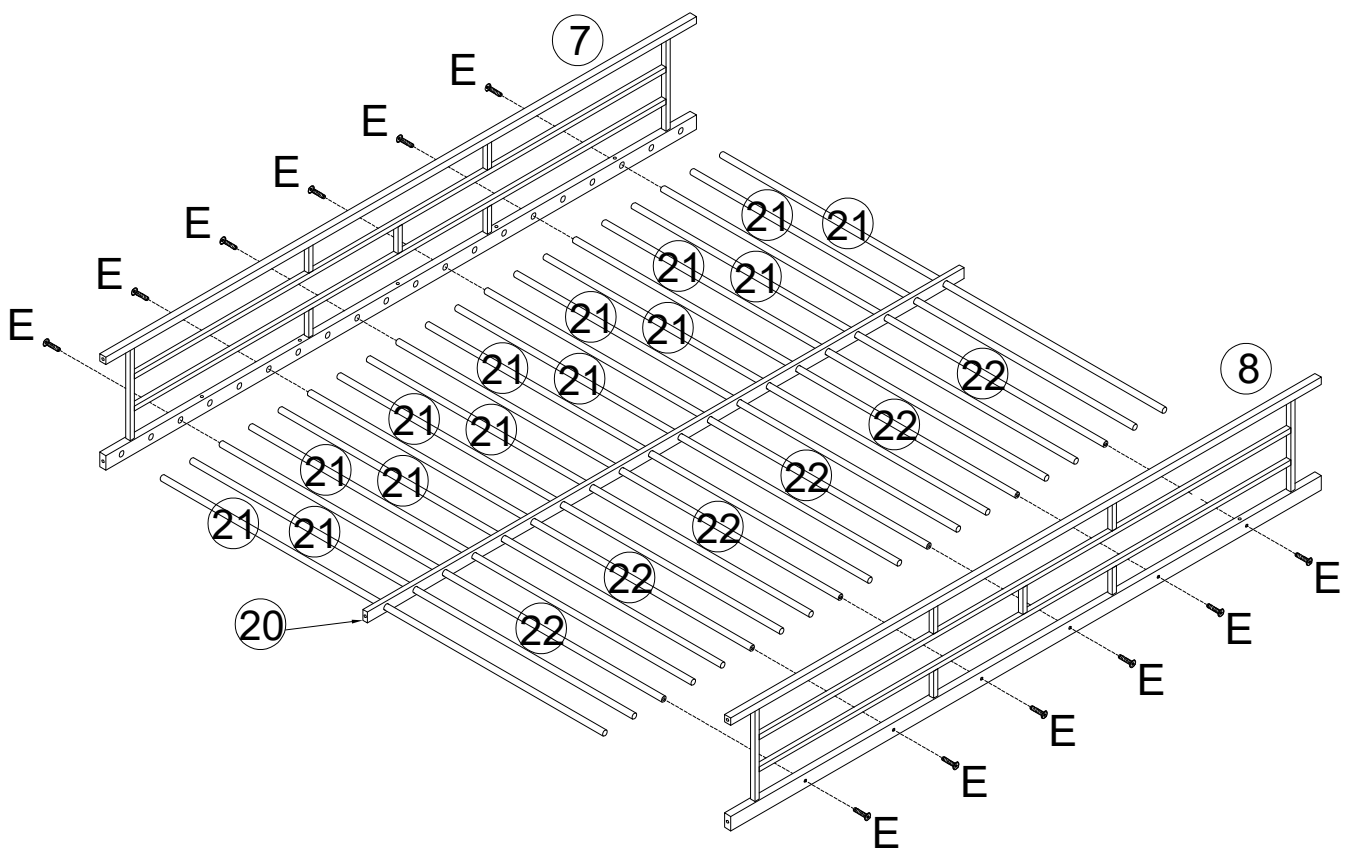
12 PCS



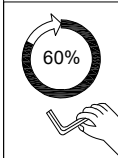
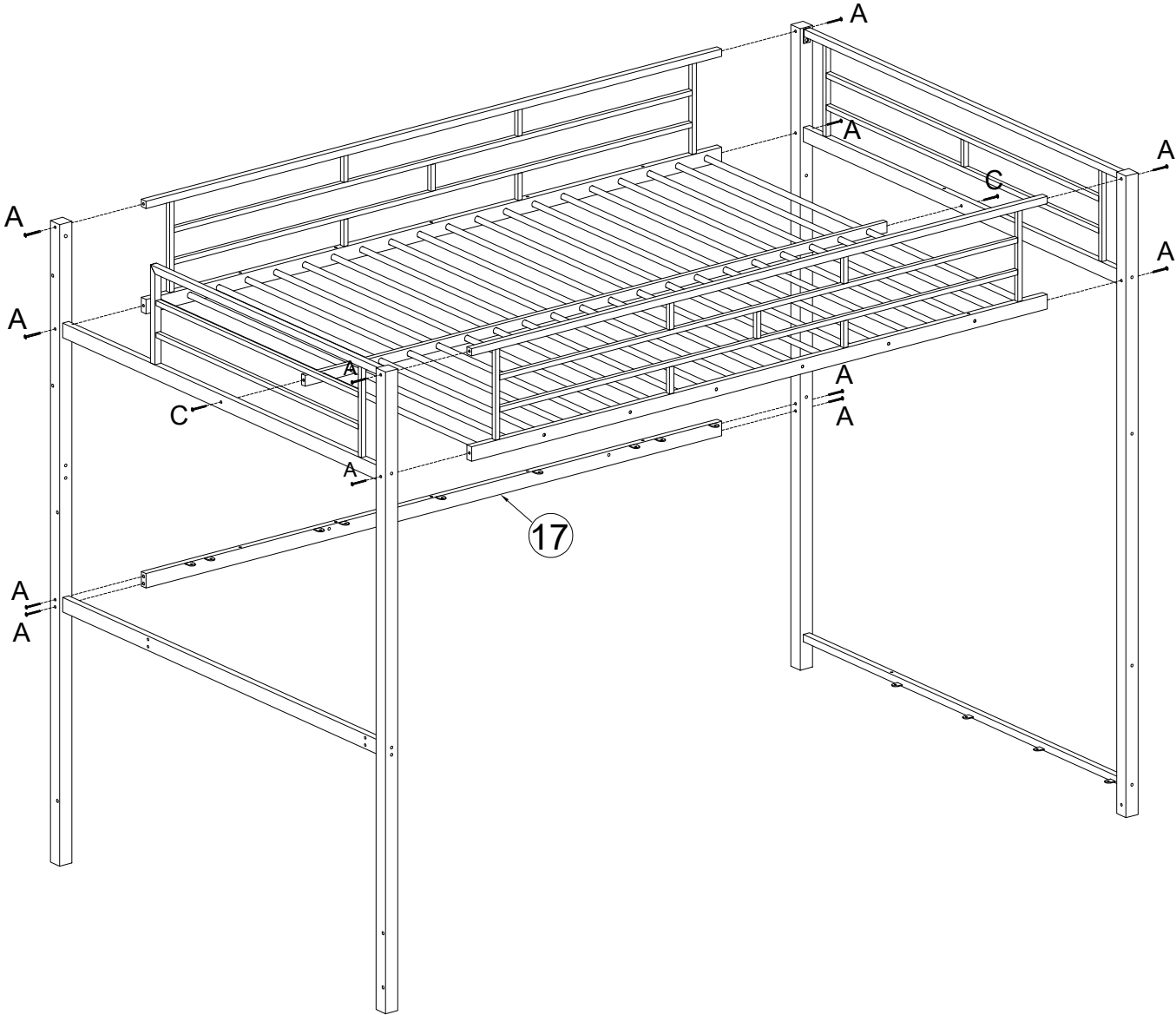

STEP 4

A	C
 M $\frac{1}{4}$ "x55	 M $\frac{1}{4}$ "x35
12 PCS	2 PCS



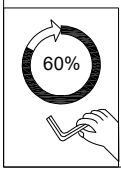
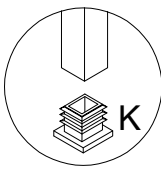
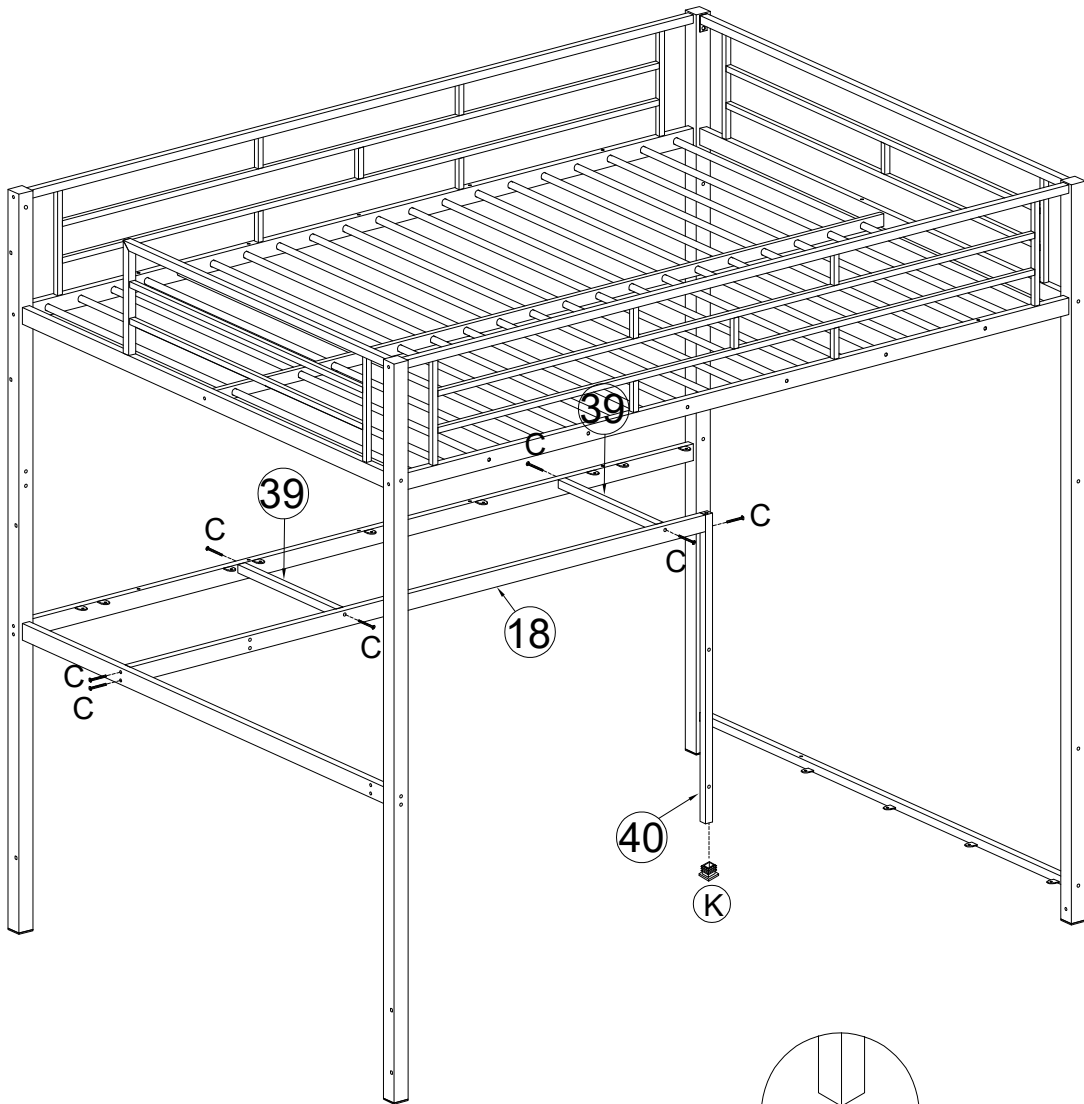

STEP 5

C	K
 M $\frac{1}{4}$ "x35	 #20x20x13
7 PCS	1 PC

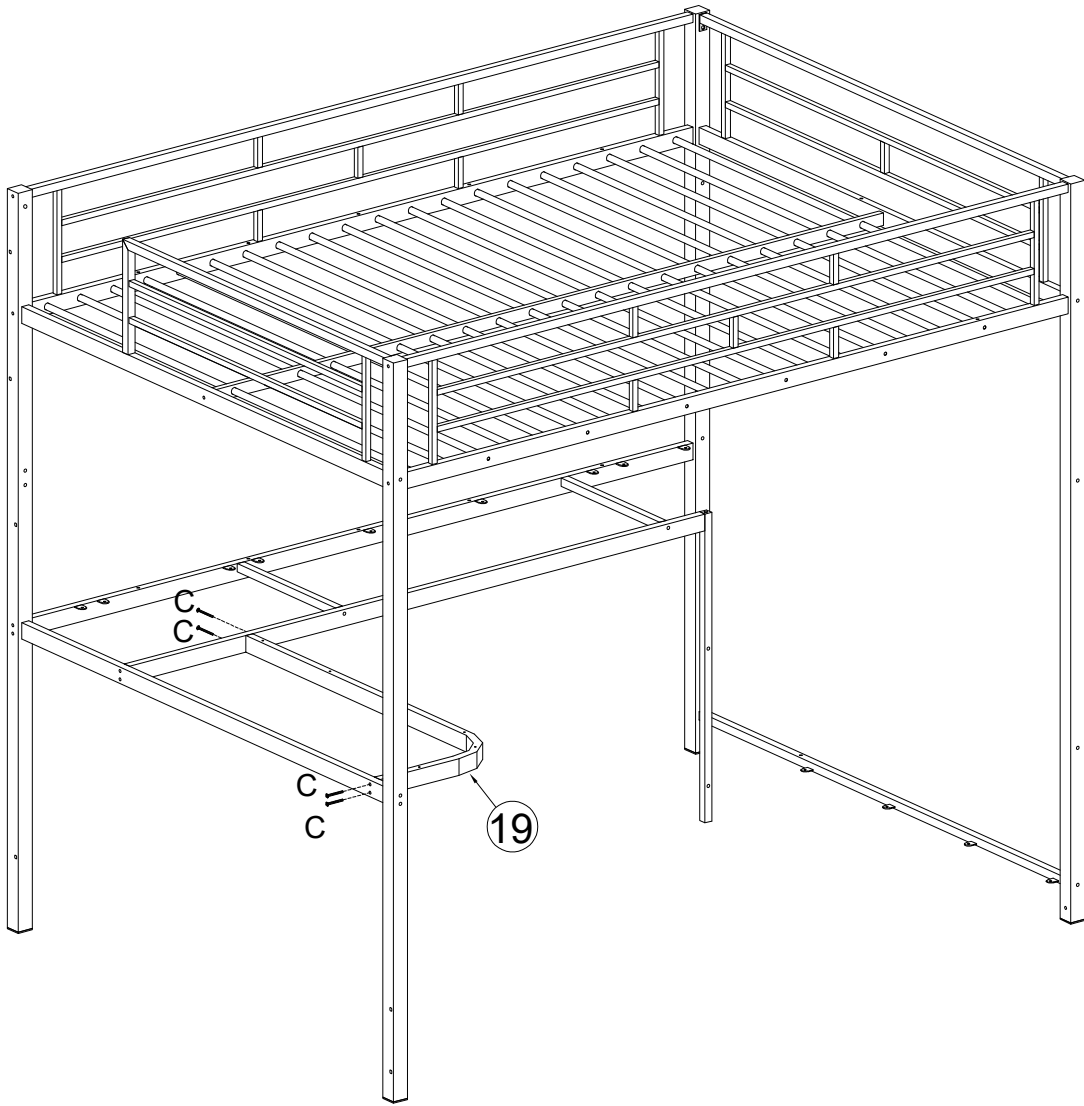

STEP 6



C
 M $\frac{1}{4}$ "x35
4 PCS

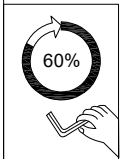

STEP 7

3 SET

1 SET

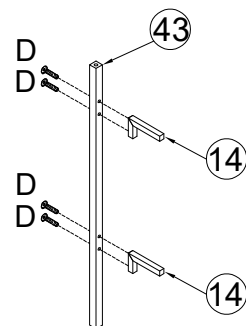
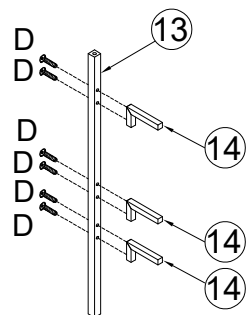

D
 M $\frac{1}{4}$ "x30
22 PCS

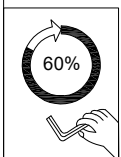

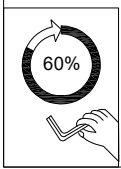
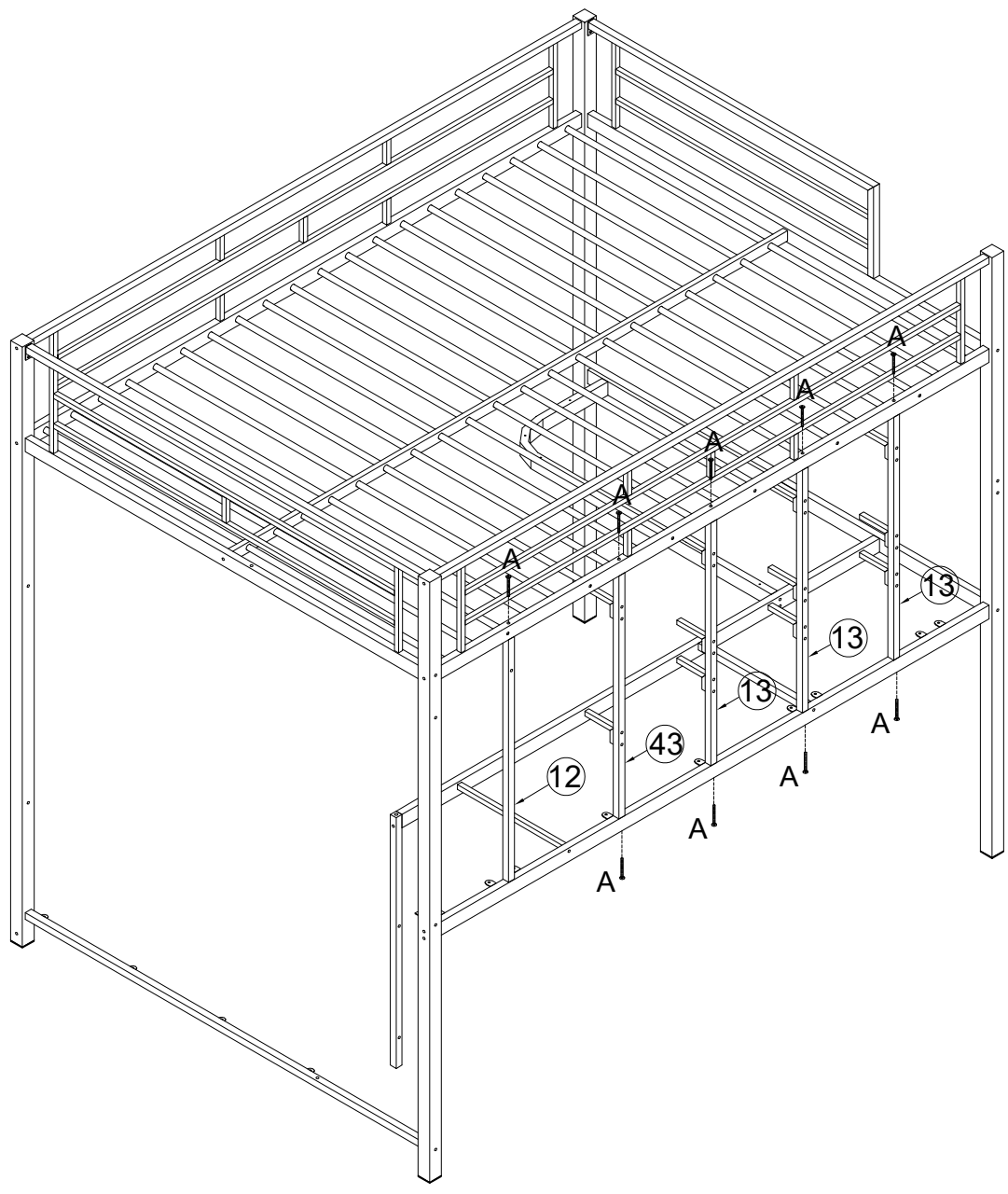

STEP 8

A

M $\frac{1}{4}$ x55
9 PCS



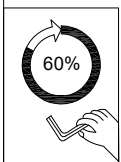
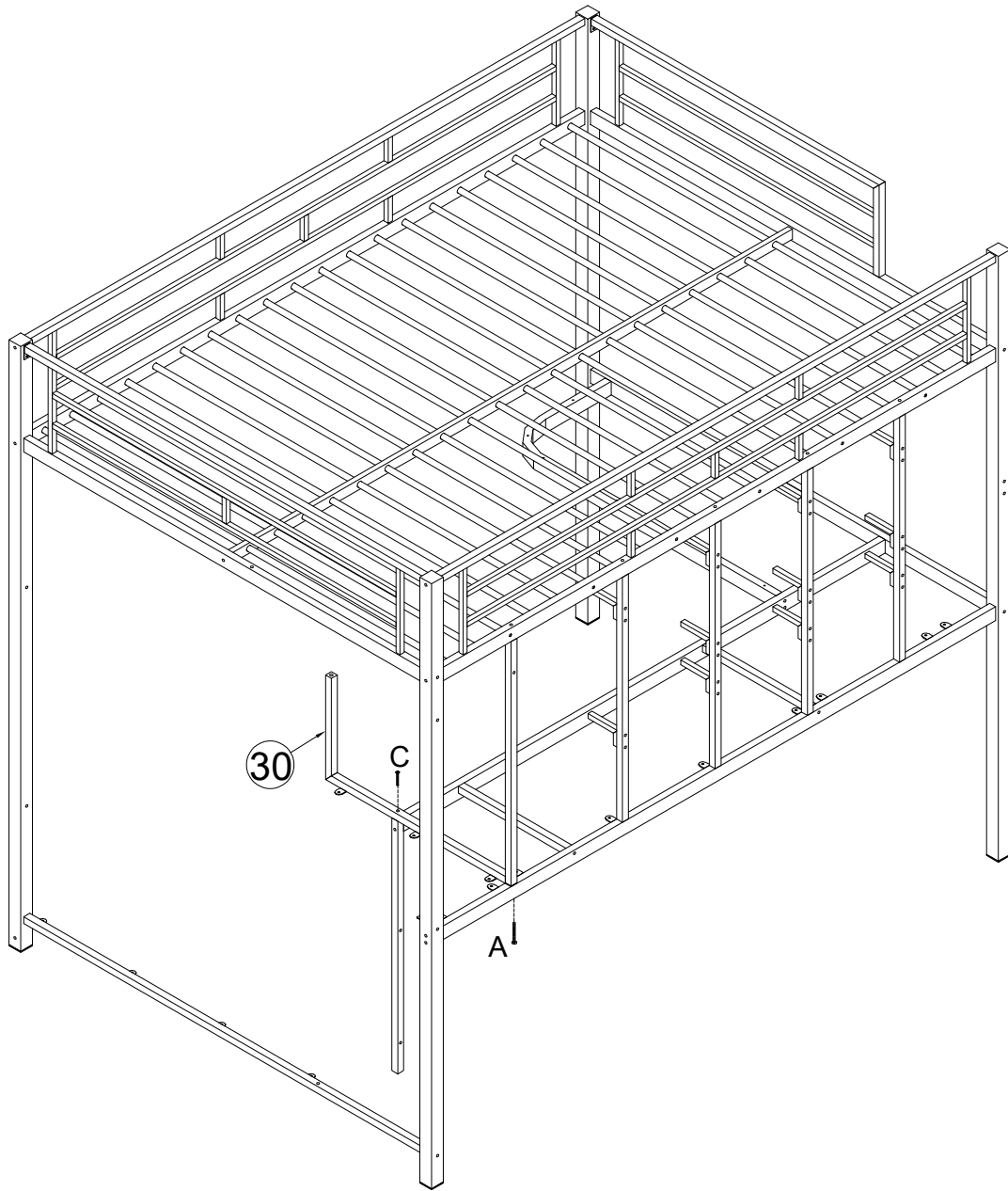

STEP 9

A	C
 M $\frac{1}{4}$ "x55	 M $\frac{1}{4}$ "x35
1 PC	1 PC



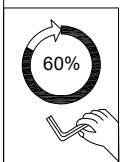
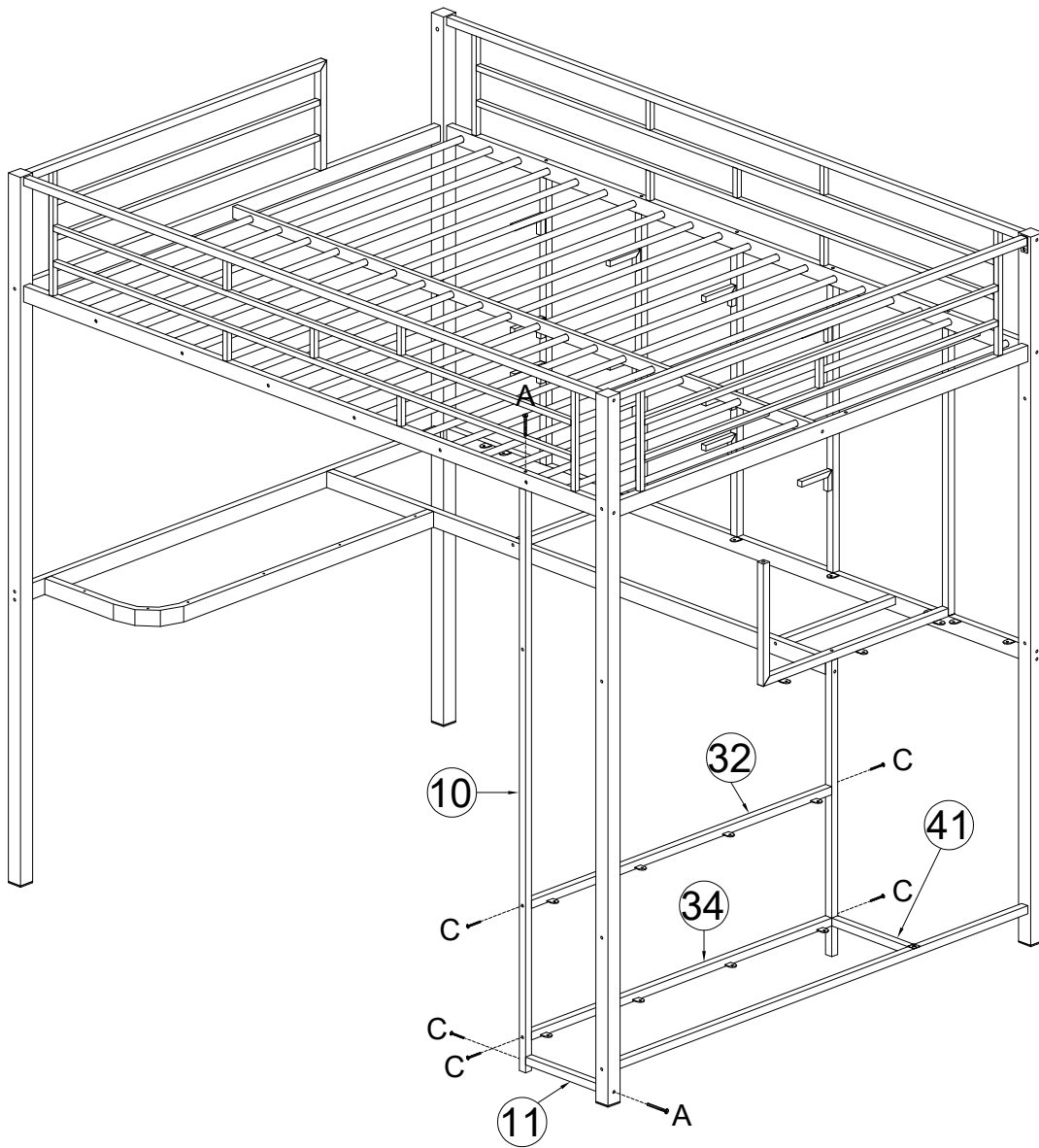

STEP 10

A	C
 M $\frac{1}{4}$ "x55	 M $\frac{1}{4}$ "x35
2 PC	5 PCS



STEP 11

A	C
 M $\frac{1}{4}$ "x55	 M $\frac{1}{4}$ "x35
1 PC	2 PCS

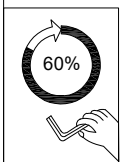
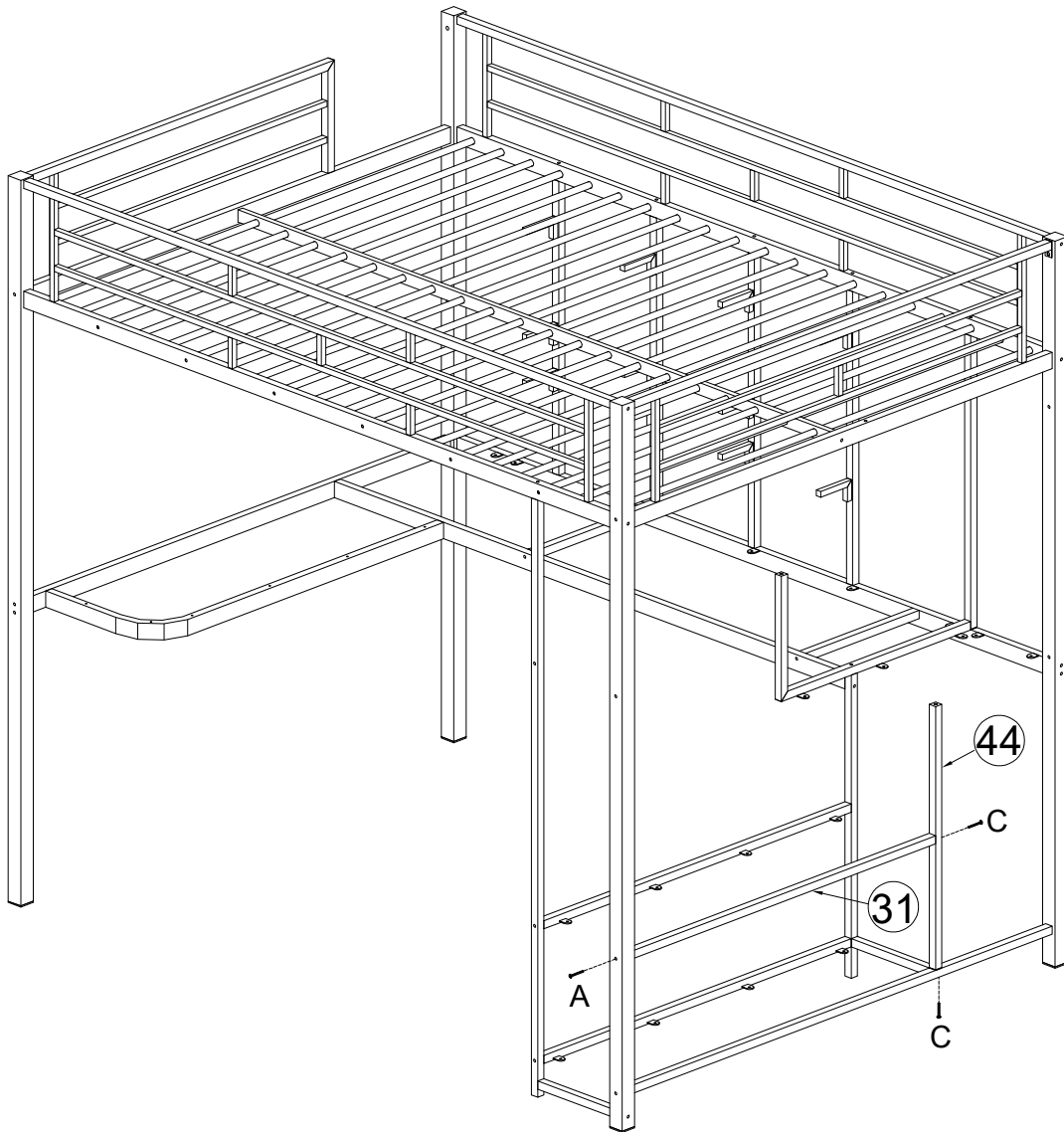

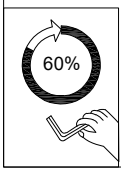
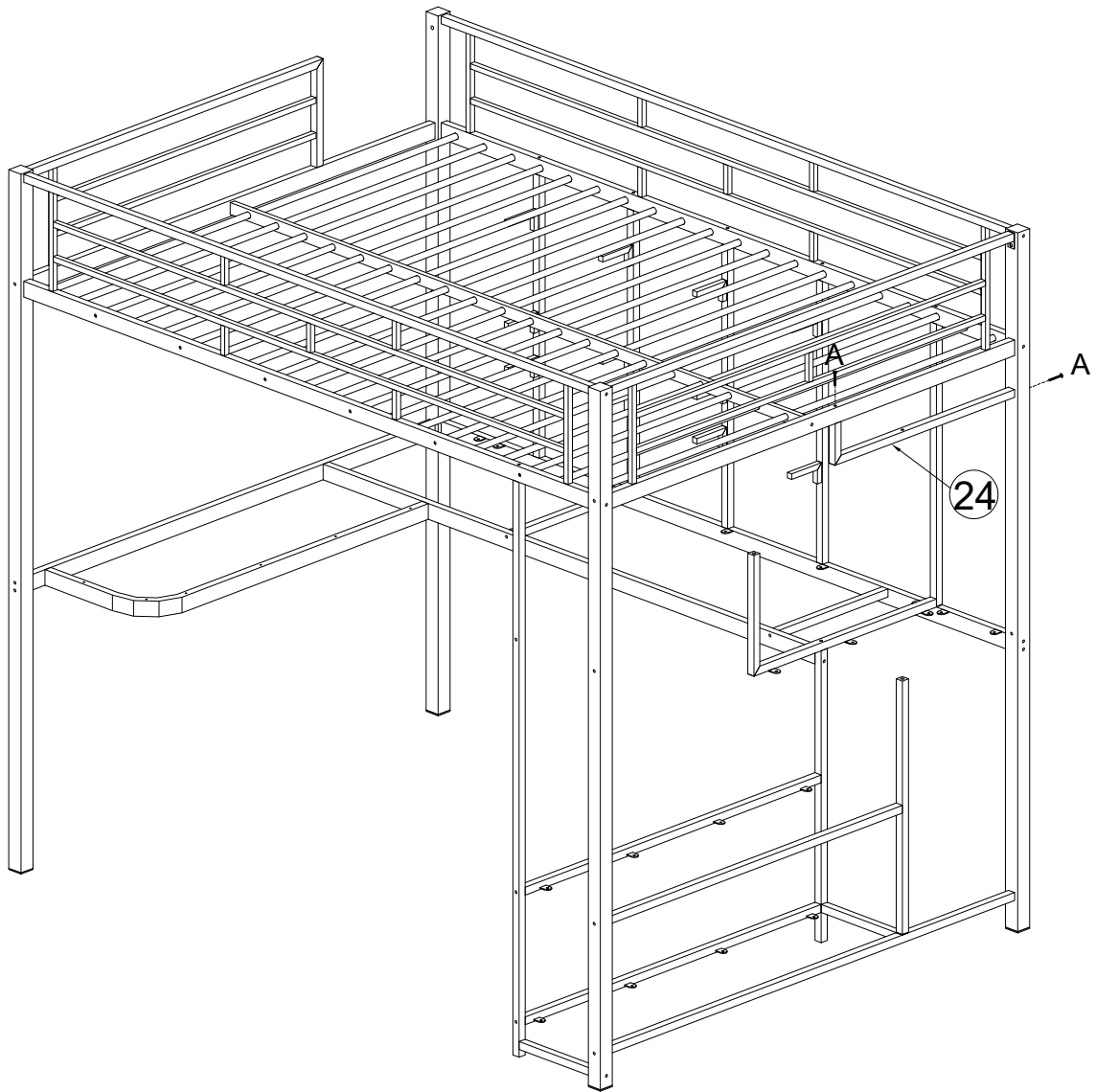

STEP 12

A
 M $\frac{1}{4}$ "x55
2 PCS



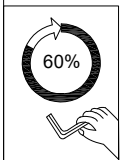
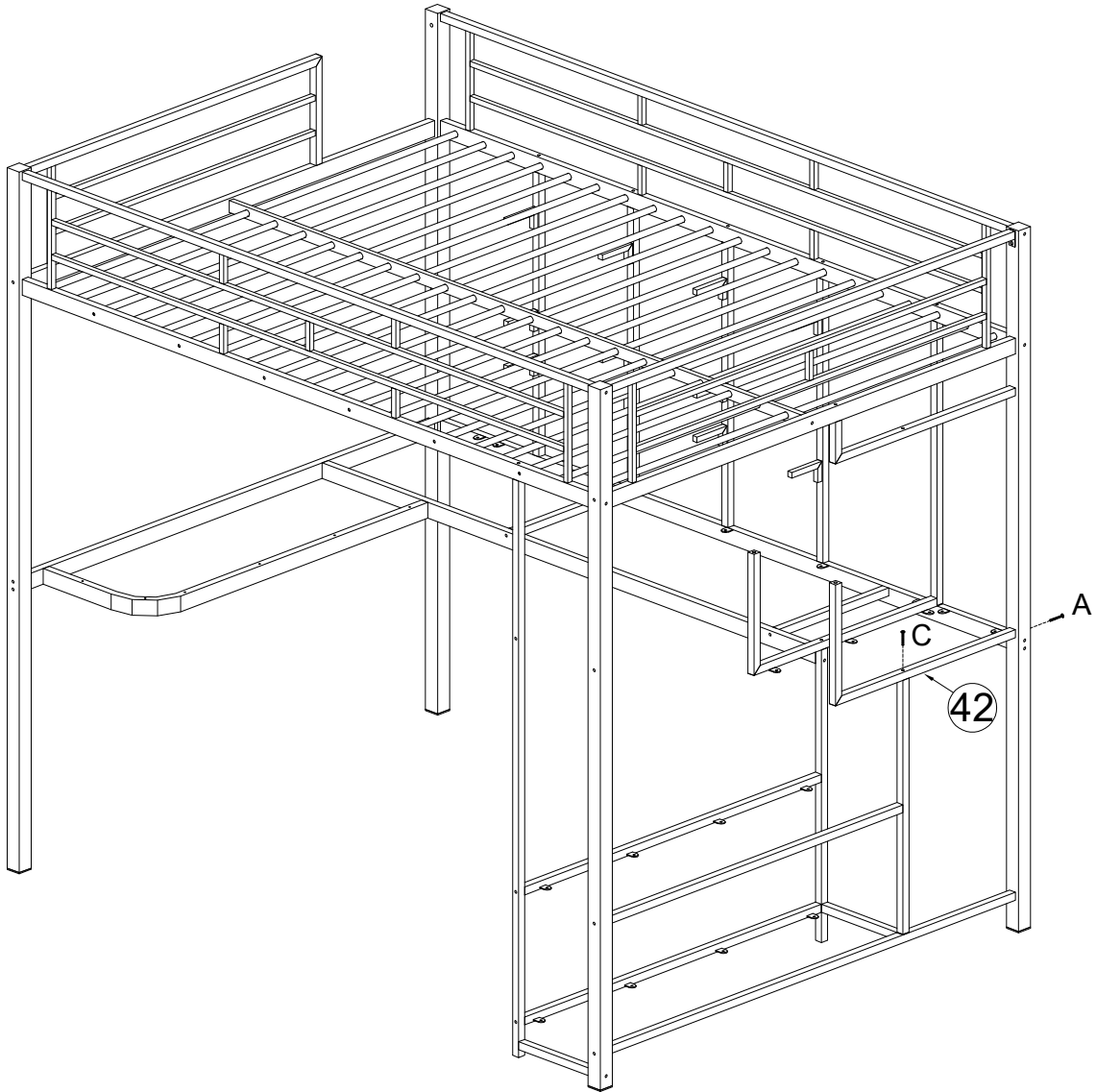

STEP 13

A	C
 M $\frac{1}{4}$ "x55	 M $\frac{1}{4}$ "x35
1 PC	1 PC

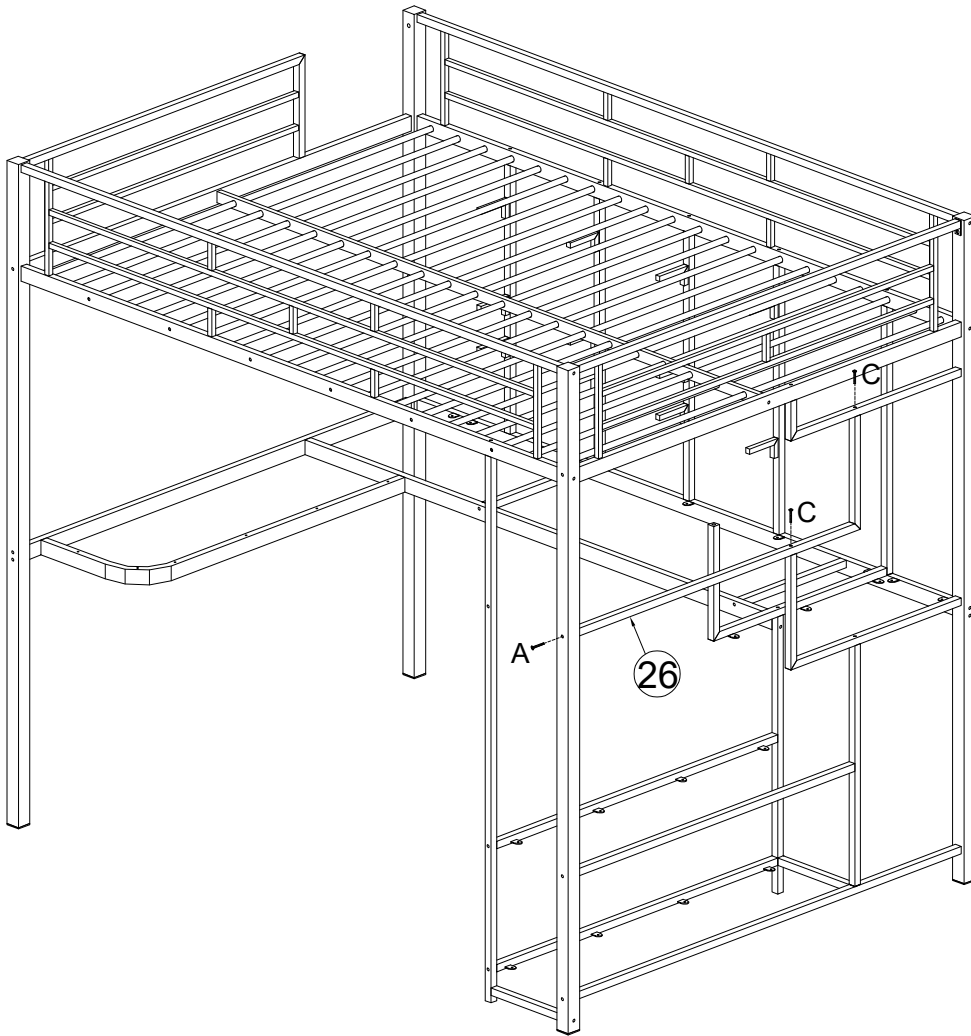

STEP 14



A	C
 M $\frac{1}{4}$ "x55	 M $\frac{1}{4}$ "x35
1 PC	2 PCS



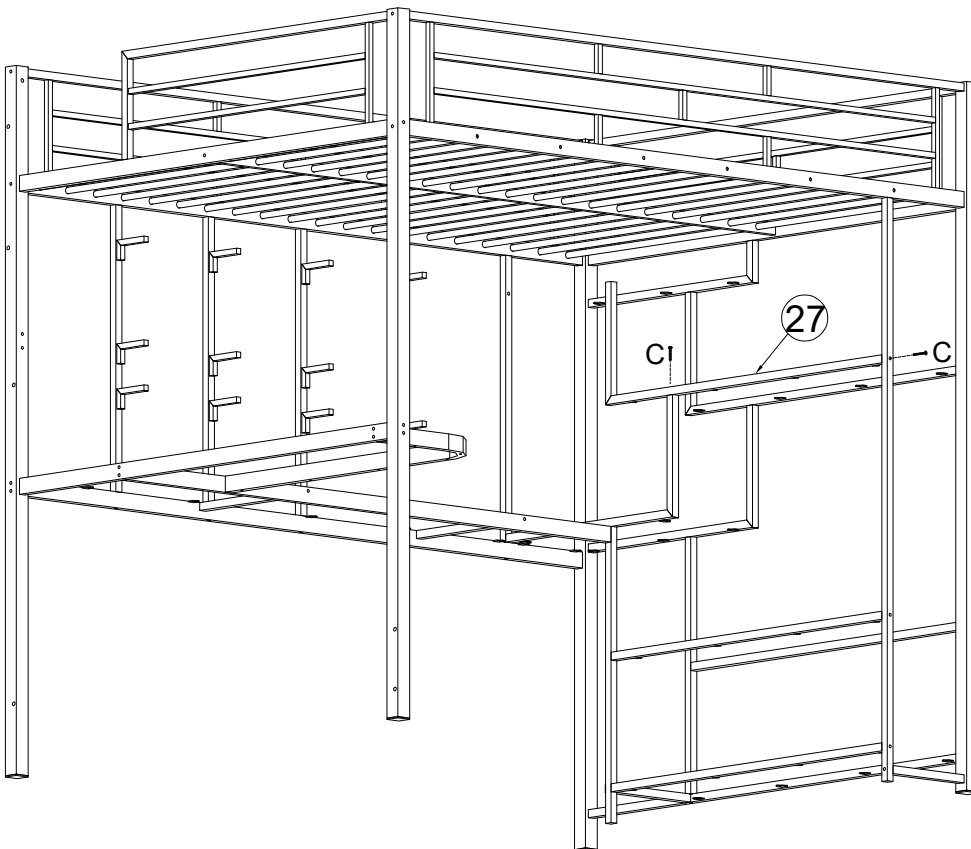

STEP 15



C
 M $\frac{1}{4}$ "x35
2 PCS



STEP 16

B	C	K
 M $\frac{1}{2}$ x50	 M $\frac{1}{2}$ x35	 #20x20 x13
2 PCS	2 PCS	1PC

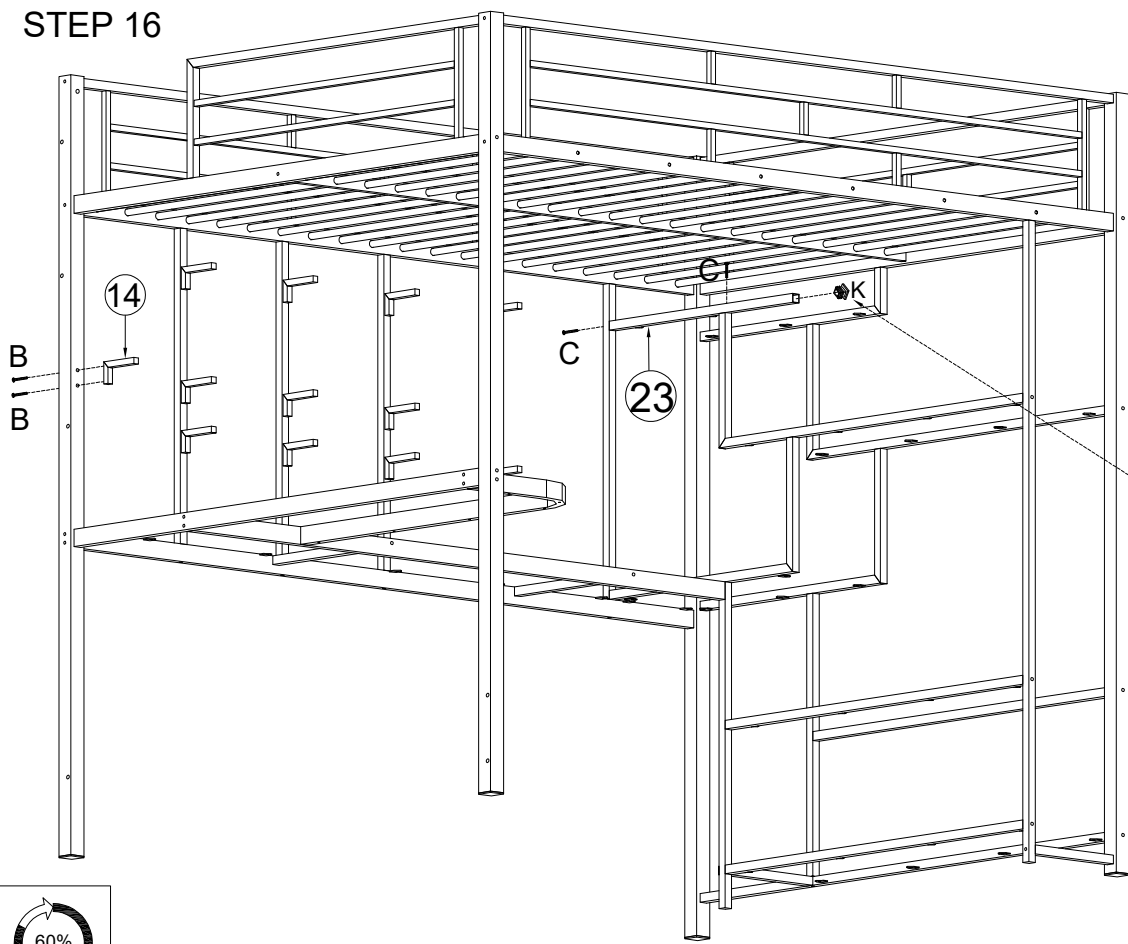

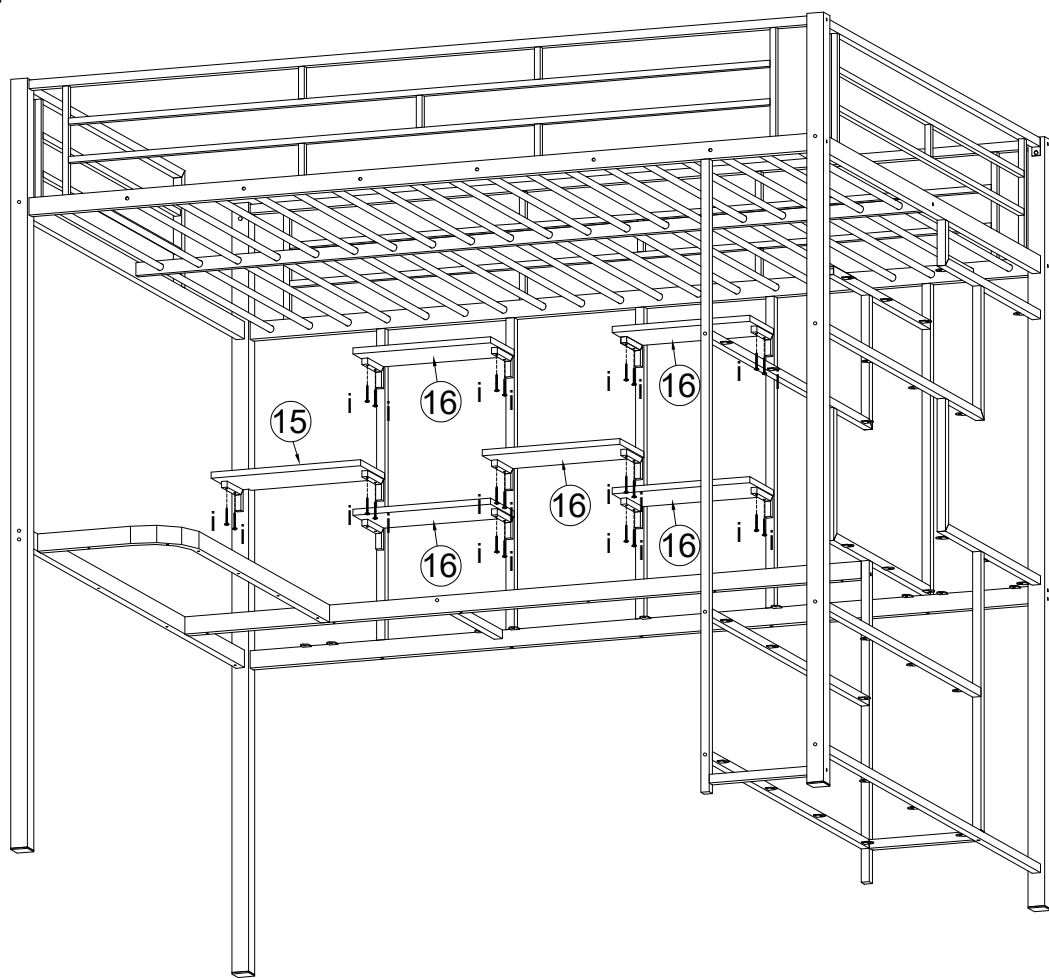

STEP 17

i
 M4x25
22 PCS



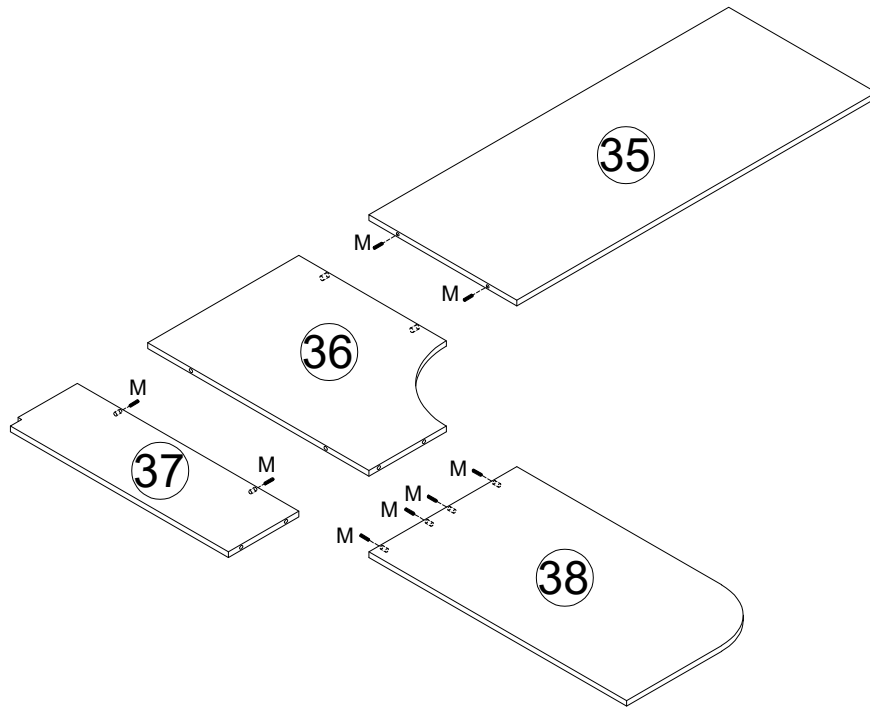

STEP 18

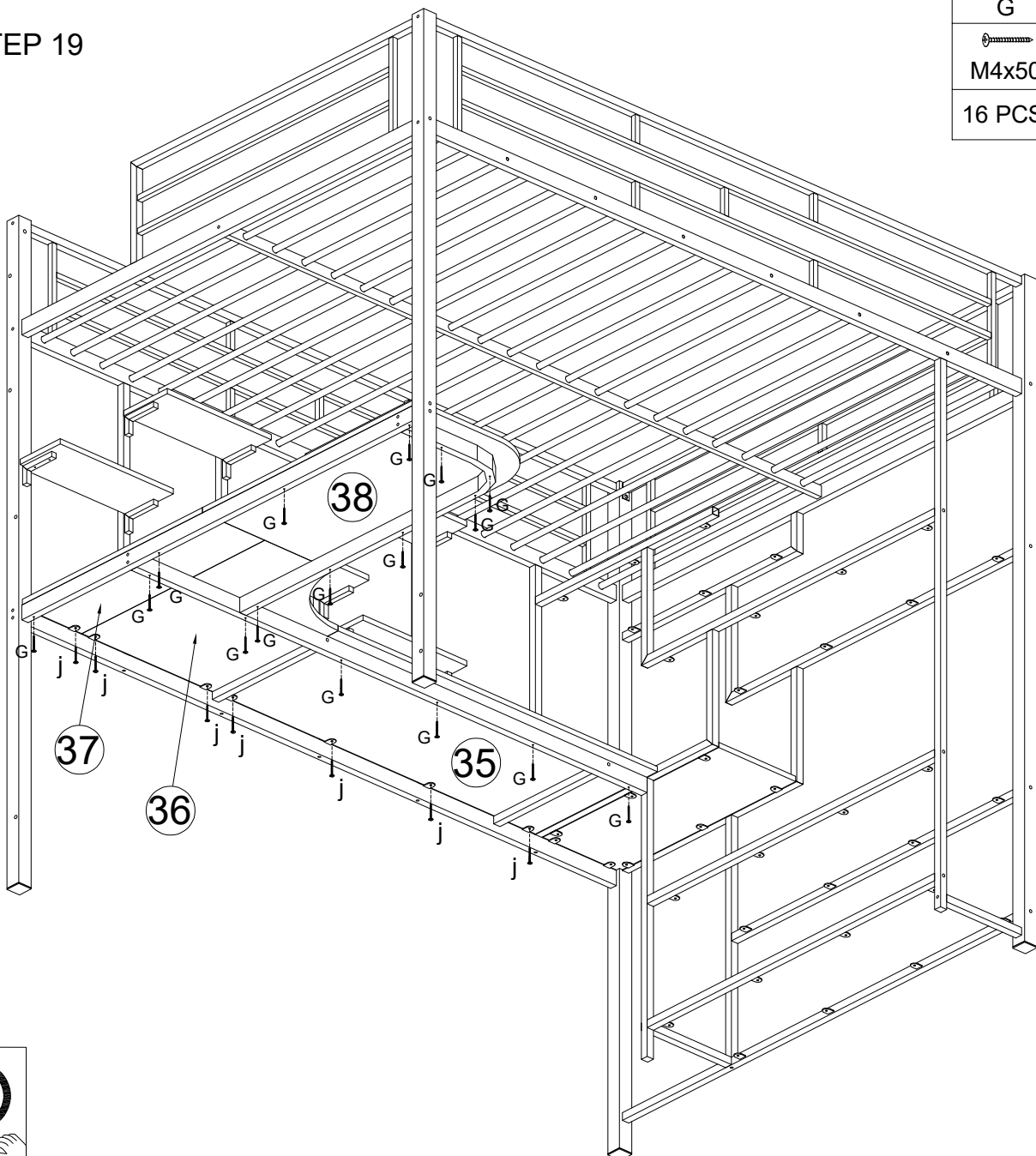

M
 Ø8x25
8 PCS

STEP 19



G	j
 M4x50	 M4x15
16 PCS	7 PCS

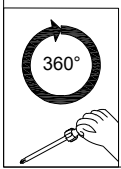

STEP 20

j



M4x15

38 PCS

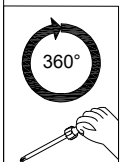
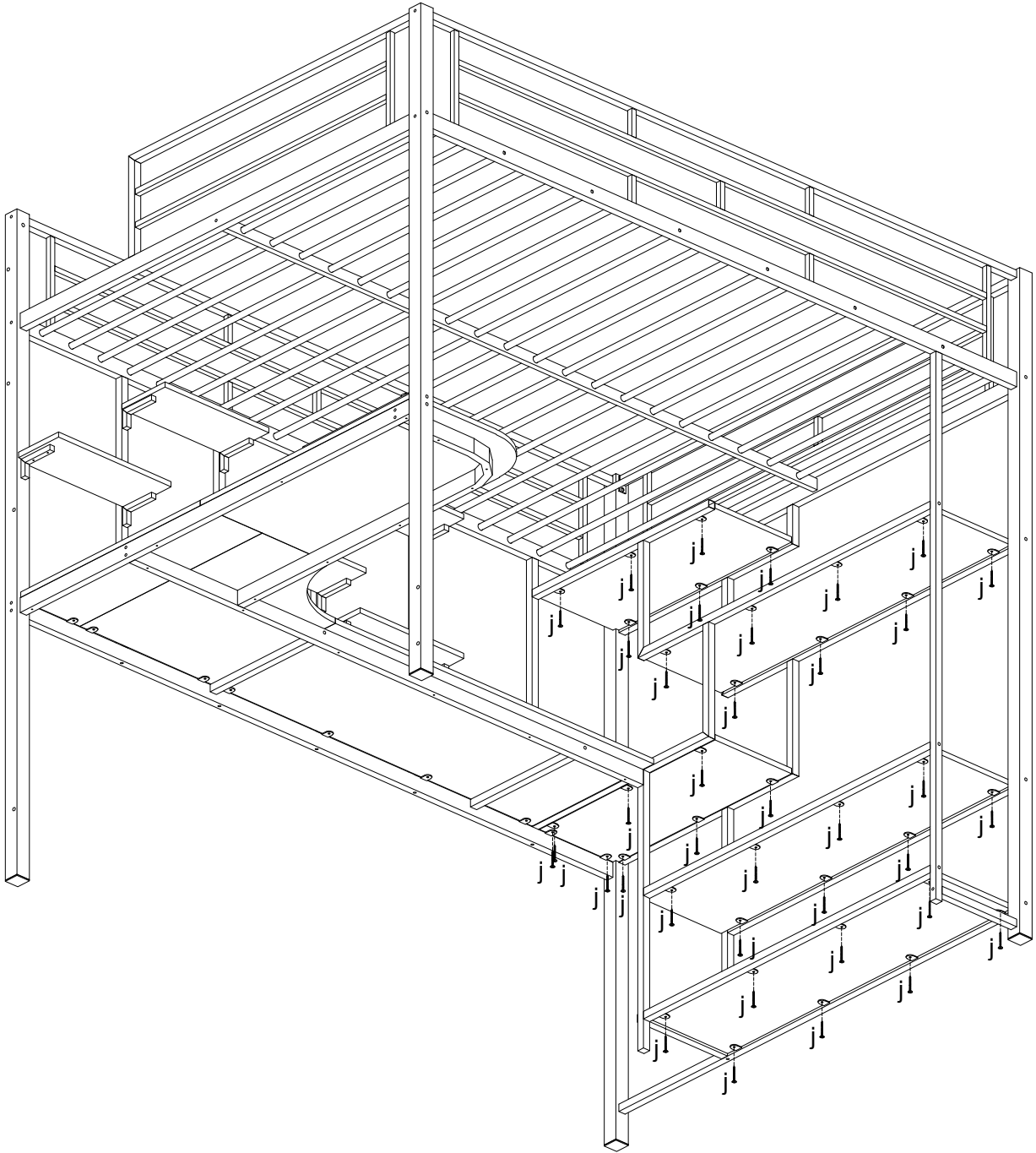

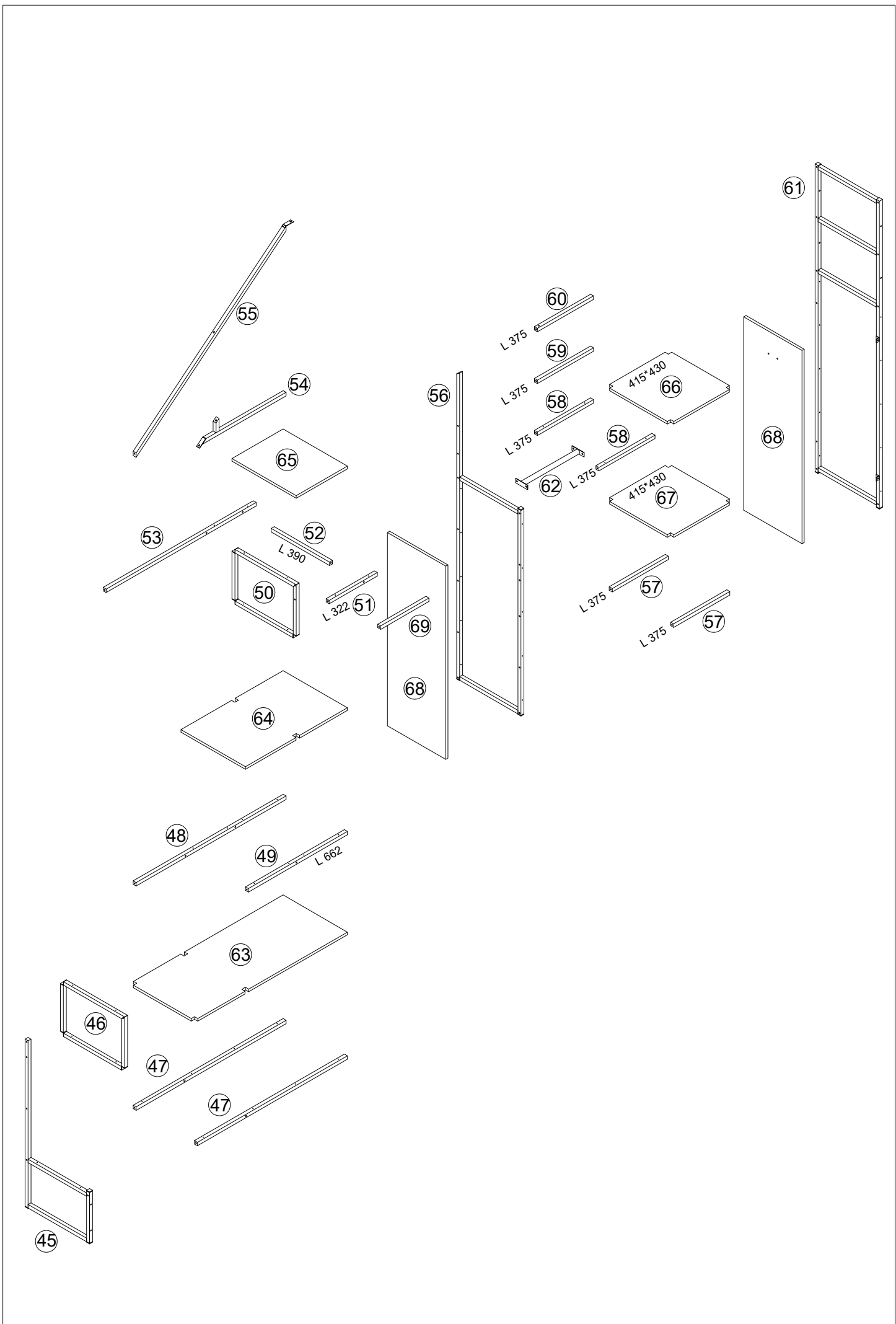

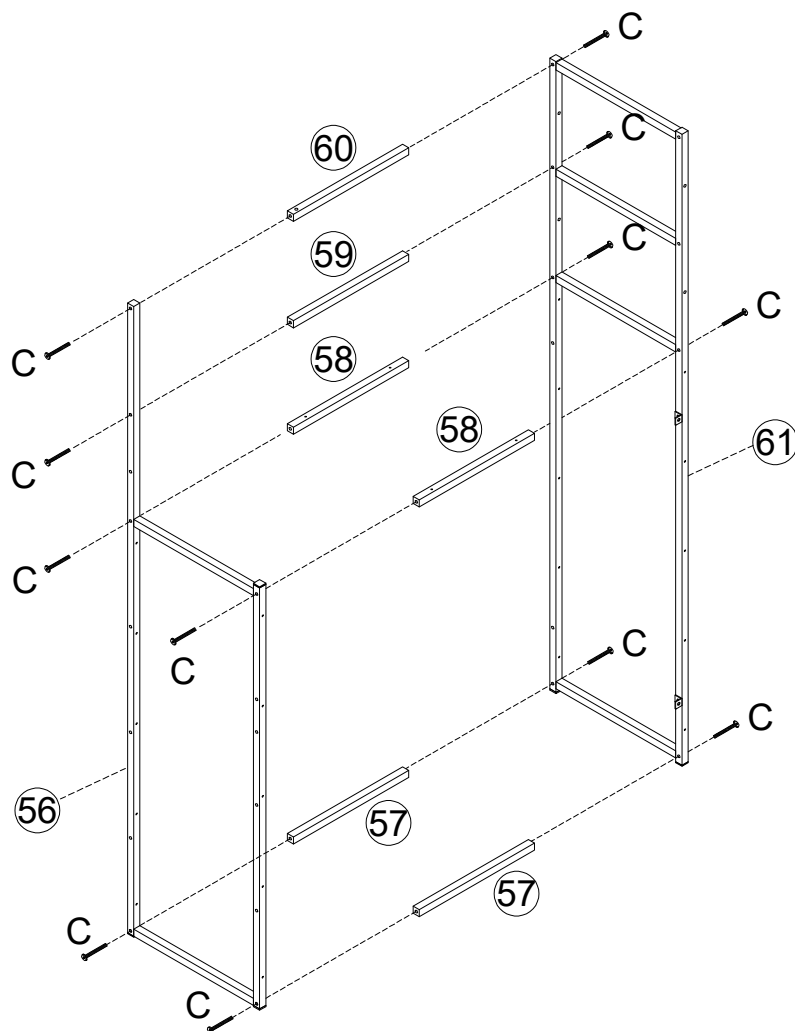

STEP 21



C
 M $\frac{1}{4}$ "x35
12 PCS

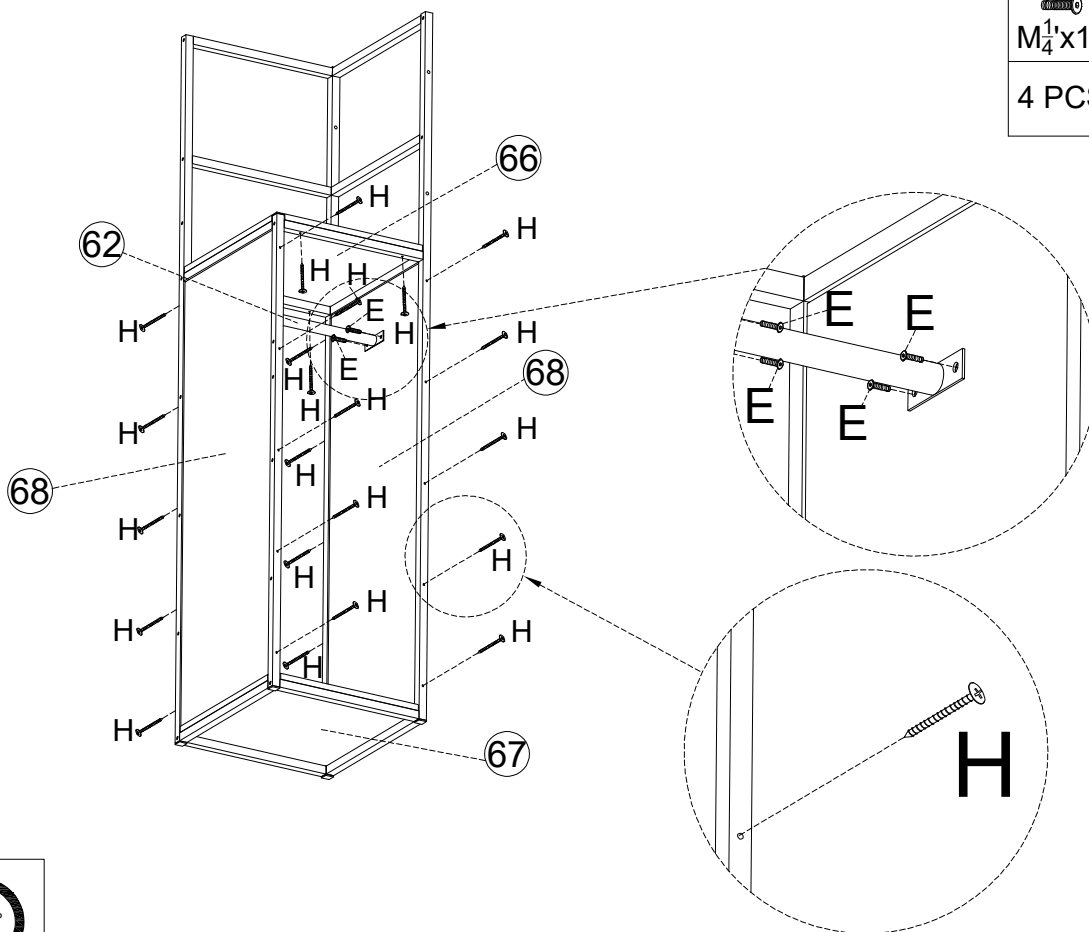

STEP 22

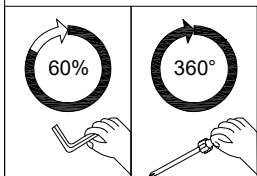

E	H
 M $\frac{1}{4}$ "x15	 M4x30
4 PCS	24 PCS



STEP 23

C	E
 M $\frac{1}{4}$ "x35	 M $\frac{1}{4}$ "x15
14 PCS	2 PCS

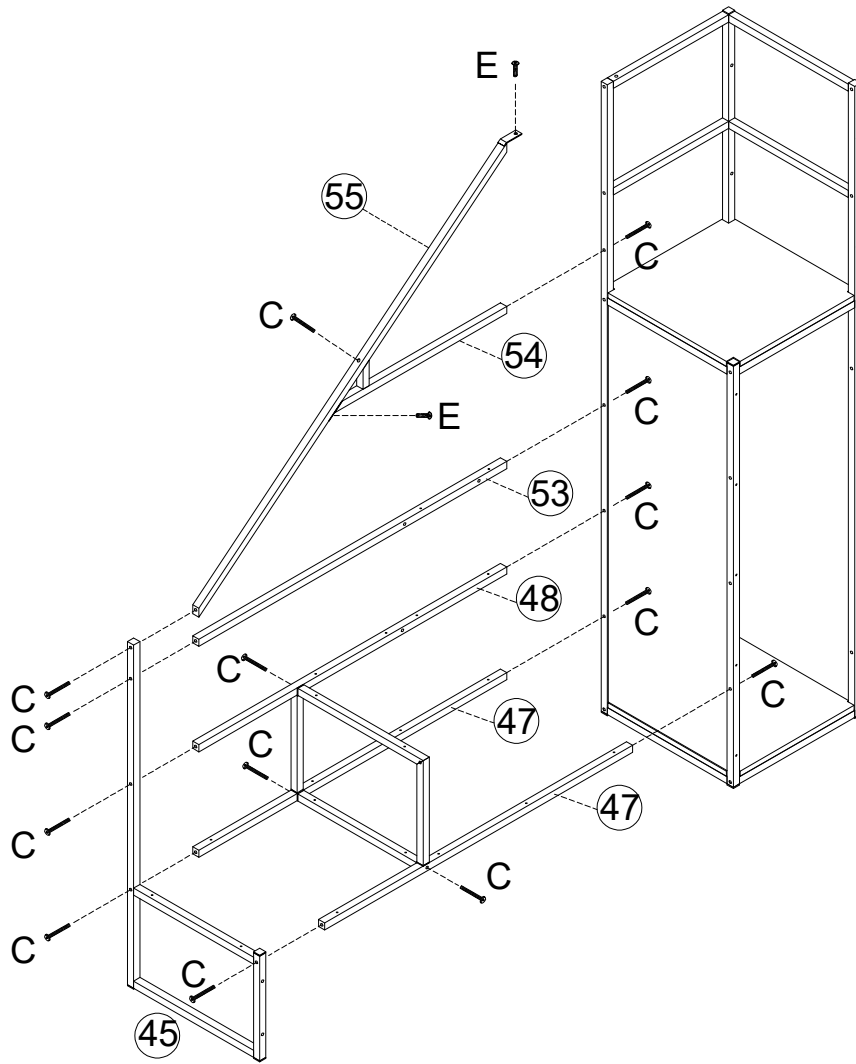



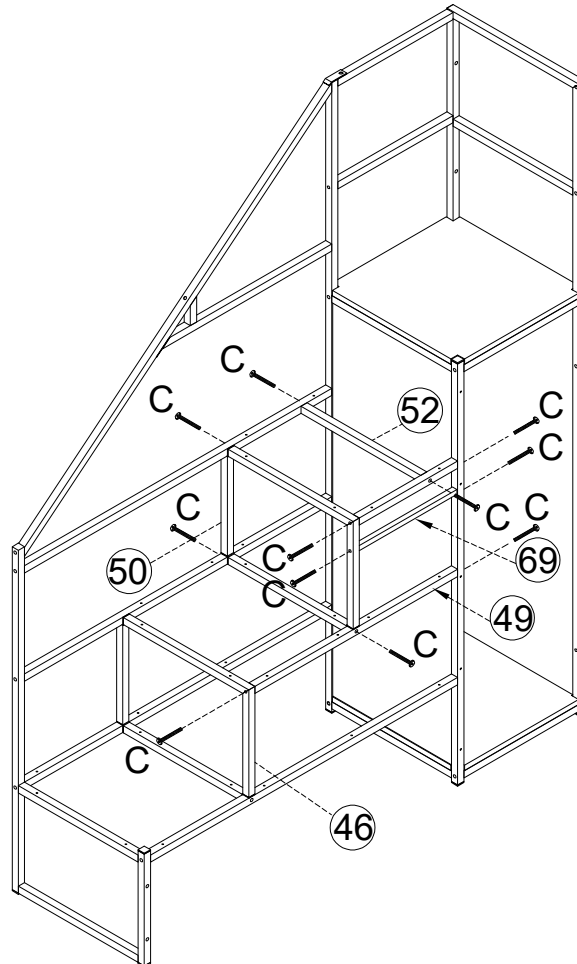

STEP 24

C
 M $\frac{1}{4}$ "x35
11 PCS



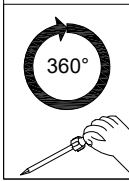
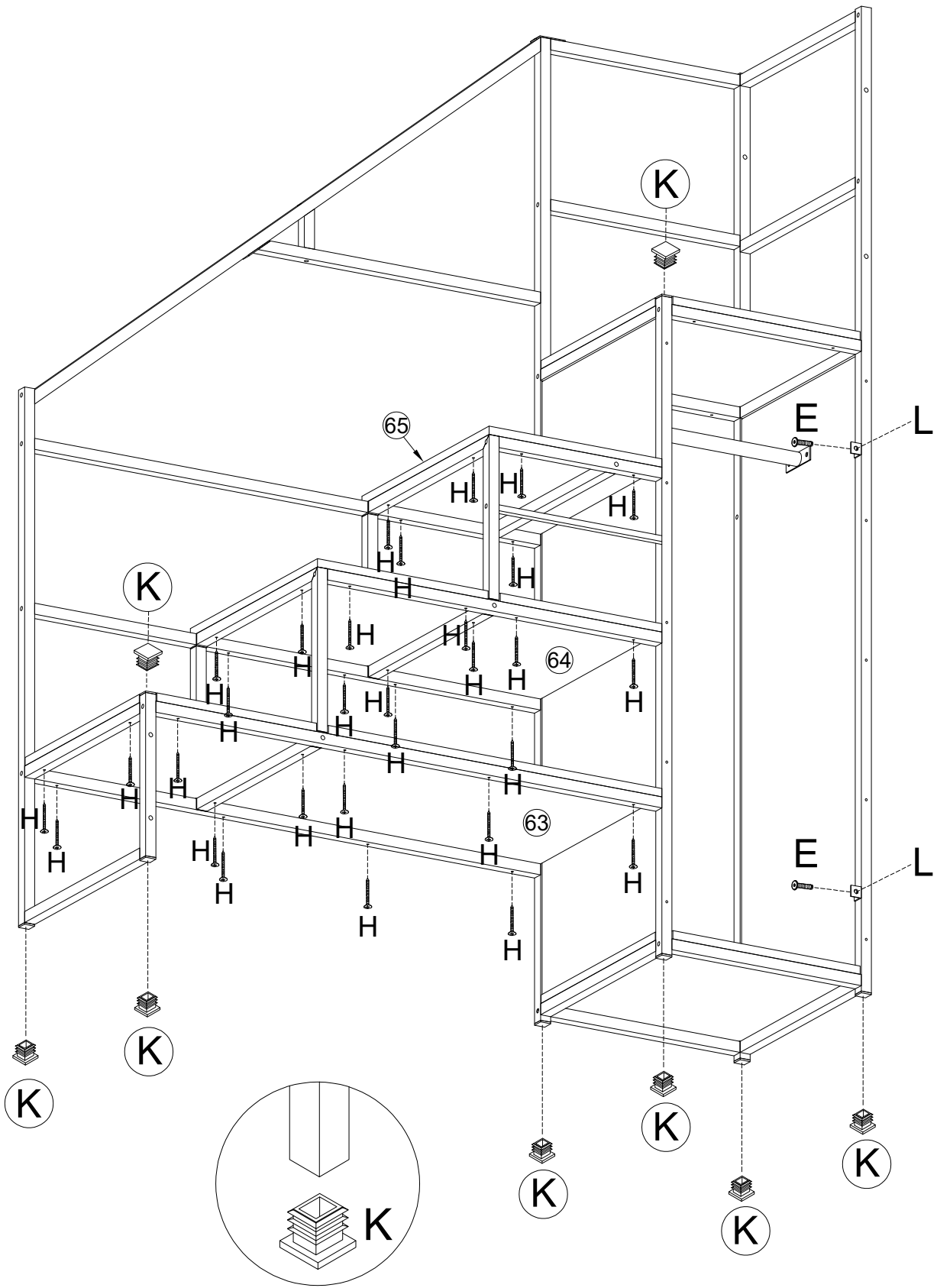

STEP 25

E	H	L	K
 M $\frac{1}{4}$ x15	 M4x30	 20x20	 #20x20x13
2 PCS	30 PCS	2 PCS	8 PCS



STEP 26

C	E
 M $\frac{1}{4}$ "x35	 M $\frac{1}{4}$ "x15
4 PCS	2 PCS

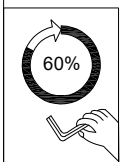
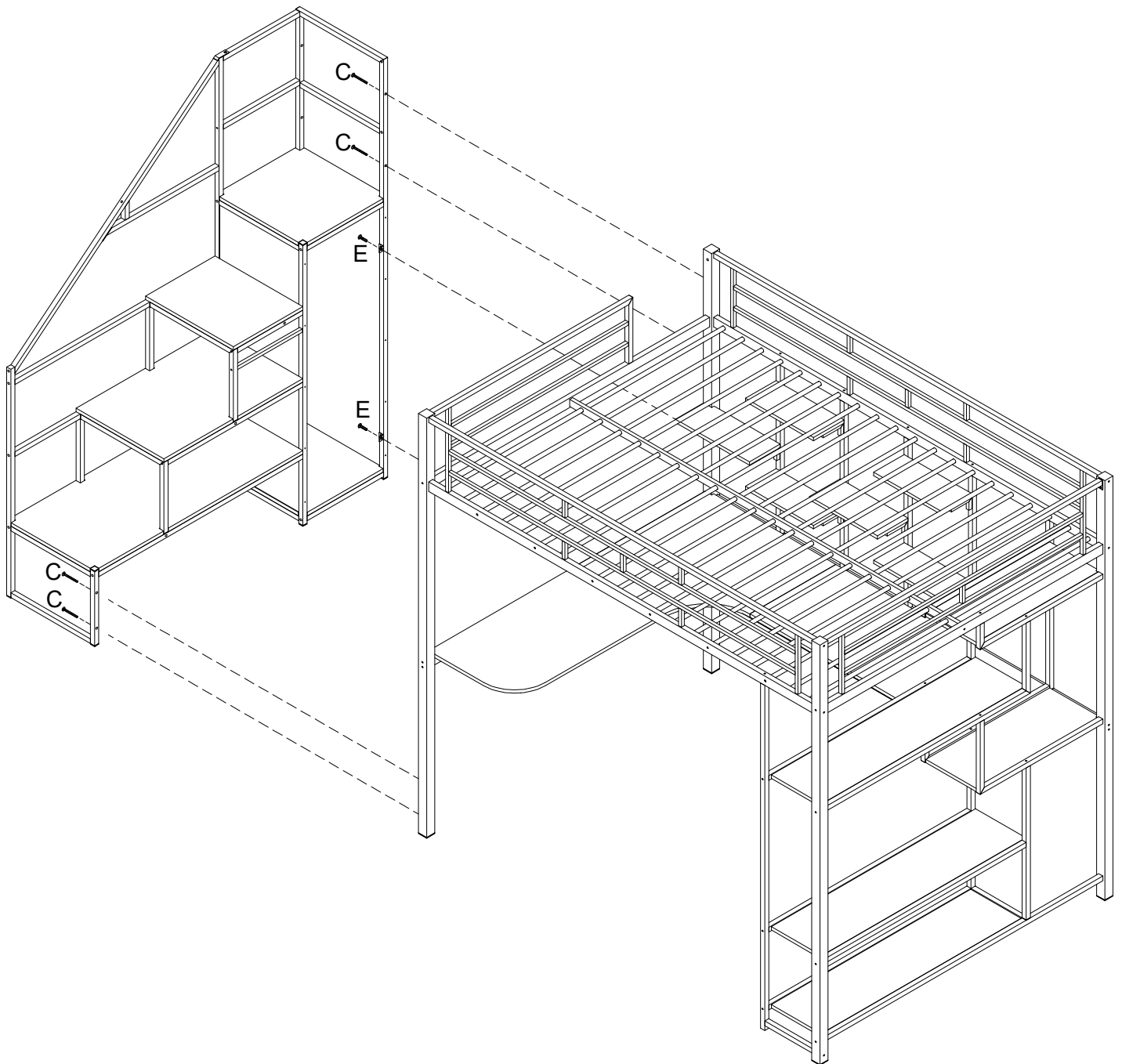

STEP 27

