

Installing your **SCHWUNG** Odyssey Linear MD

Collection

Odyssey

2023



Our goal is to bring energy, warmth and pleasure into your personal space. It's great to be here.

Safety
instructions 6

Components
and features 7

Assembly
instructions 8

Cleaning and
maintenance 12

Troubleshooting 13

Safety instructions



**We recommend installation
by a licensed electrician.**

Safety instructions

These instructions are provided for your safety. It is very important that they are read completely before beginning the installation of your fixture.

1. Turn off electricity at the main circuit breaker panel before beginning installation.
2. This direct wire fixture must be installed by a certified and licensed electrician. The customer should not attempt to install.
3. This fixture has been rated for up to 12 (L) 40W max E12 base bulbs. To avoid the risk of fire, do not exceed the recommended wattage.
4. If any special control devices are used with this fixture, follow the instructions to assure full compliance with the N.E.C. requirements.
5. This fixture should only be used with a trailing edge dimmer.
6. Mounting hooks and wall anchors are not included. To select the proper type of mounting hook /wall anchor for your wall/ceiling please contact your local hardware store for assistance. If you have any questions, contact a licensed electrical contractor.

Warnings

- Do not mount or unmount the glass cylinders if the fixture or light bulbs are hot.
- All wires are connected. Do not remove the ceiling light from its packaging by pulling on the power cord, as a bad connection may result.
- Do not use if the light cable/cord is damaged.
- To reduce the risk of fire, electrical shock or personal injury, always turn off the light fixture and allow it and the globes to cool prior to replacing light bulb.
- When mounting the fixture, always use the cotton gloves included.
- Do not touch bulb when fixture is turned on. Do not look directly at lit bulb.
- Keep flammable materials away from lit bulb.

Components and features

FEATURES

- Hand-crafted in brass
- Mouth-blown glass cylinders

COMPONENTS

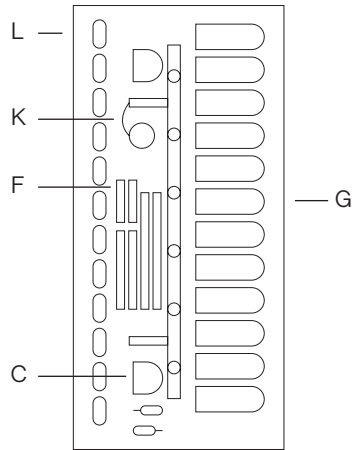
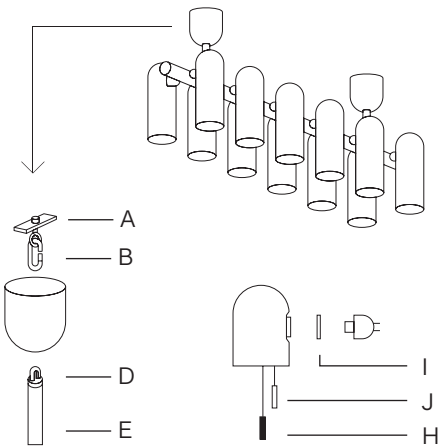

- A Cross-bar with hooks (2x)
- B Quick links (2x)
- C Canopies (2x)
- D Loop nuts (2x)
- E Main rods (2x)
- F Extension rods (6x)
- G Glass cylinders (12x)
- H Retainer rings (12x)
- I Inner rings (12x)

- J Outer rings (12x)
- K Wiring (1x)
- L Light bulbs (12x):
Max wattage 40W
Bulb base E12
Max length 80mm

Required Tool:
Flat-head screwdriver

Assembly instructions



Make sure you cut off power supply at the main fuse box/circuit breaker before commencing any work.

1

Carefully unpack the contents.

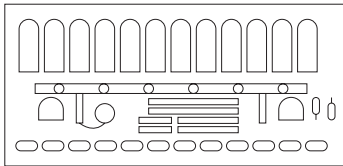

2

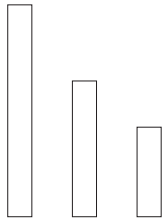

Are you installing extension rods?

YES: Continue to Step 3

NO: Jump to Step 6

3

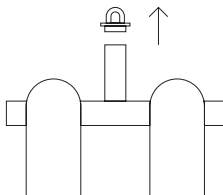

Unscrew the two loop nuts [D] from the two main rods and remove them, making sure the wires are not damaged in the process.

4

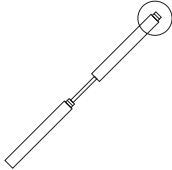

Carefully pull the electrical wires through the extension rods [F] one at a time, then attach the extension rods of the same diameter on the side without electrical wires.

NOTE: Make sure the rods are positioned with the outer thread facing downwards.

5

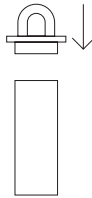

Pull the cords through the loop nut [D] and screw it into the main rod. Do the same with the loop nut on the side without electrical wires.

NOTE: Make sure the cord endings are not frayed. If they are, twist them back together.

6

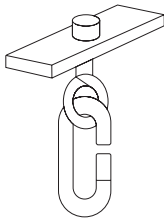

Turn Power Off!

Connect the cross bars included with the hooks to your ceiling junction boxes, or directly to the ceiling (screws not included).

NOTE: If in doubt, consult your local hardware store. The non-electrical side can also be hung on ceiling hooks of another type.

7

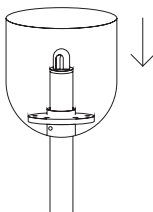

Insert the canopies [C] onto the chandelier rods, making sure that you pull the electrical wires through the canopy opening first. Lower both canopies gently to the bottom, loosening the lock screws with a flat-head screwdriver.

8



Place the quick links into the cross-bar loops, then lift the chandelier and hang it onto the quick links. Turn the nuts to close both quick links tight.

NOTE: Two people may be needed for this step.

9

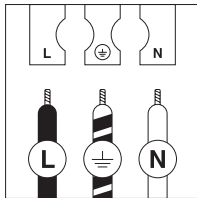

Make all necessary electrical connections. The diagram on the left shows the most common markings and manner of connecting the cords.

NOTE: We recommend installation by a licensed electrician.

10

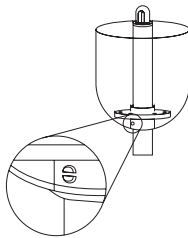

Lift each canopy [C] flush against the ceiling and turn the lock screw a quarter turn clockwise.

NOTE: Do not force the screw as the thread can break.

11

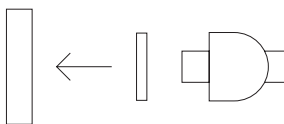

Remove the retainer ring [G] from the bulb socket, and place the larger inner ring onto the socket.

NOTE: Once the side is angled to face the socket, the ring will hang loose. You will position it in the next step.

12

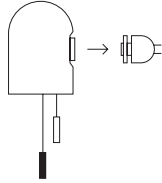

To mount the glass cylinder, place the smaller outer ring [J] onto the socket and screw the retainer ring [G] onto the socket to secure the glass cylinder. The inner and outer rings let you set the cylinder in the right position. Repeat for all sockets. Make sure the cylinders are aligned.

13

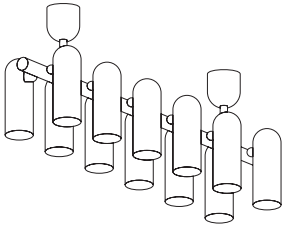

Insert the 12 40W max E12 light bulbs included into the sockets (80mm long). Restore power and test the fixture. Assembly is complete. Enjoy your Schwung Lamp.

Cleaning and maintenance



Make sure you cut off power supply to the lamp before commencing cleaning operations.

Components	Maintenance	Tools
Brass Frame	Clean every month using a soft cloth, dampened slightly with water. Make sure the frame is dry before switching the lamp back on.	Soft cloth, water
Glass cylinders	Clean regularly with a soft dry cloth. Clean only the outside of the cylinder. If especially dirty, use a wet cloth first. Grease can be removed with a gentle glass cleaner.	Soft cloth, Cotton gloves (!)
Light bulbs	Make sure your power supply is off before changing the bulb. Unscrew the globe where bulb needs replacing. Gently remove the bulb by pulling it out and replace with a LED bulb of the same parameters.	LED bulbs, Cotton gloves (!)

NOTE: Please remember, solid brass may tarnish over time. This is a natural process. Make sure you follow our guidelines to preserve the great look of Schwung lighting for years.

Troubleshooting

Problem	Possible Cause	Action
Tarnishing	Oxidation of brass is a natural process. Although it is lacquered, its color may change slightly over time.	No action is necessary apart from regular cleaning. See the Maintenance section.
Crooked hanging	Wrong positioning of cylinders.	Loosen the retainer ring and position the cylinder correctly. Turn the retainer ring gently to secure the position.

NOTE: Dear client, please be assured our team strives to deliver highest quality products. The handmade nature of the products offers a unique aesthetic experience and allows for small imperfections, which is inherent in crafts. If solutions offered below are not sufficient, please do not hesitate and contact our customer service.

Having trouble?

We're sorry to hear that.

Our enlightened objects are designed for longevity.

Each piece is made by hand to ensure the highest possible quality and a unique aesthetic experience.

This means you may encounter small surface imperfections. We like to think of them as whispered greetings from our craftspeople. But should you have any concerns about your product and the previous solutions fail to help, please don't hesitate to email us at info@schwung.design