



Item #: MN900QHB/MN900QFB/MN900SR
 Description: MILAN QUEEN HEADBOARD
 MILAN QUEEN FOOTBOARD
 MILAN QUEEN SIDERAILS

Product Size: 64.25" X 3" X 62"/64.25" X 3" X 25"/82" X 2" X 8"

Your furniture purchase is an investment. Here are a few tips to maximize the lifetime of your furniture with a minimum amount of effort. Properly caring for your furniture can help ensure that it looks great year after year.

Wood furniture Maintenance:

- Always dust, wipe, and clean *with* the grain of the wood.
- Dust with a soft cloth. Dust will scratch the furniture surface if not removed properly
- Use the same type of polish consistently as interchanging oil-based and wax-based polishes will cause a build-up and result in a foggy or cloudy appearance
- If a polished surface becomes foggy, rub it with a cloth dipped in a solution of one tablespoon vinegar to one quart of water. Rub softly with the grain until the surface is completely dry
- Soap and water are not advisable for wood surfaces. Water can penetrate the finish and raise the grain on wood, causing damage.
- Remember to change dusting cloths frequently as dirty cloths may scratch your furniture's surface

The Enemies of Wood:

- Moisture is wood's worst enemy. Liquid spills should be gently wiped up immediately. Coasters should be used under all beverages.
- Do not allow or vinyl materials to lie on the furniture.
- Chemicals in rubber may leave a stain. Put a strip of felt or leather under accessories that have rubber or vinyl.
- Heat creates a chemical change in the furniture's finish, which results in a white spot. Use protective pads under hot dishes, appliances, etc.
- Sunlight's ultraviolet rays can damage the finish of furniture. Do not place furniture directly against a heater or radiator and do not place in the path of hot streams of air from central heating. This will cause extreme localized drying of the wood.

High Gloss Resin Table Maintenance:

- Resin tabletops have approximately 1/8" of a resin coat on the top face of the table, which will resist ice, water, wine, liquor, food, cleaning fluids and warm or hot liquids; however, cups, glasses, etc. Containing hot liquids should not be left on the table without a coaster for protection
- Resin tabletops will scratch just the same as any other glossy surface and basic precaution should be taken
- For lasting shine, the resin table should be waxed with a car wax that does not contain. Maintaining this wax build-up will result in a high gloss shine.
- When wiping down the table, a soft, clean rag should be used. Do not use a heavy paper

Granite Top Maintenance:

The surface of the granite on your table has been polished or sealed to create a generally non-porous surface. The stone has many natural characteristics including: Veining, hairline cracks, and color variations - which make up the stone's beauty.

To maintain the beauty of your granite:

- Protect surfaces from scratching, staining and etching by:
 - * Keeping them free of debris or sharp objects
 - * Wiping up spills immediately
 - * Avoiding contact with chemicals (particularly acid-based materials)
- Clean with pH neutral products or those especially formulated for use on stone.
- It is not recommended to use a water-based solvent for dark granite as it will remove the polish from the surface. Absorbed into the stone.
- After a period of use, apply a penetrating sealer to prevent contaminants from being
- Remove stains with special absorbent poultices formulated for use on stone.
- Renew the surface on polished granite (granite with a high gloss surface) by buffing with special stone polish, powder or cream.
- Do not use granite on granite with a matte finish, which has been honed rather than polished (penetrating sealer may be used on both polished and honed granite)

Marble Top Maintenance:

Marble may be stone, but it is porous stone and can stain easily. Treating marble surfaces the same as wood surfaces is a great rule of thumb. It is recommended to seal the tops on a regular basis (every 6 to 12 months) A good quality stone sealer can be purchased from any tiles/ stone store or any homeware store and should be applied according to the manufacturer's recommendation.

- When sealed properly, marble tops can be used indoors and outdoors and can withstand any weather conditions except internal freezing. Snow or freezing rain will penetrate the table and cause cracks

Caring for the Fabric on Upholstered Furniture:

- Frequent vacuuming of the entire upholstered area will prevent dust from settling into the fibers.
- Professional cleaning is always recommended for all upholstered pieces.
- Always pre- test a small area of fabric in an inconspicuous area when cleaning before proceeding.
- Do not use cleaning products containing brightening agents

VERY IMPORTANT !!

NEVER USE GLASS CLEANERS ON FINISHED SURFACES. AMMONIA WILL CHEMICALLY ATTACK THE FINISH.

DO NOT WRITE DIRECTLY ON SURFACE



PREVENT MARKING

DO NOT PLACE DIRECTLY IN SURFACE



PREVENT FADING

DO NOT USE PLACEMATS WITH RUBBER BASES



PREVENT DISCOLORING

NEVER ALLOW LIQUIDS OF ANY KIND TO LINGER ON SURFACES. ABSORPTION CAUSES THE WOOD TO WARP AND THE FINISH TO DE-LAMINATE.

DO NOT USE COMMERCIAL POLISHER AND WAXES



PREVENT YELLOWING

DO NOT PLACE HOT POTS, ETC. ON SURFACE



PREVENT DAMAGE TO FINISH!

REGULATE THE HUMIDITY CONDITIONS AT YOUR HOME



PREVENT SPLITTING

MN900QHB/MN900QFB/MN900SR ASSEMBLY INSTRUCTIONS

Step 1: Attach the Top stretcher (B) and Bottom stretcher (C) to the Left Leg (D) and Right Leg (E) by using Flat Washer (3), Lock Washer (2) and Bolt (1) through the frame. Secure well by Allen Key (4).

Step 2: Place the Headboard Panel (A) on the floor with a piece of cloth or carpet underneath to prevent finish from scratching. Attach the completed Headboard leg to the Headboard Panel (A) by using Flat Washer (3), Lock Washer (2) and Bolt (1) through the frame. Secure well by Allen Key (4).

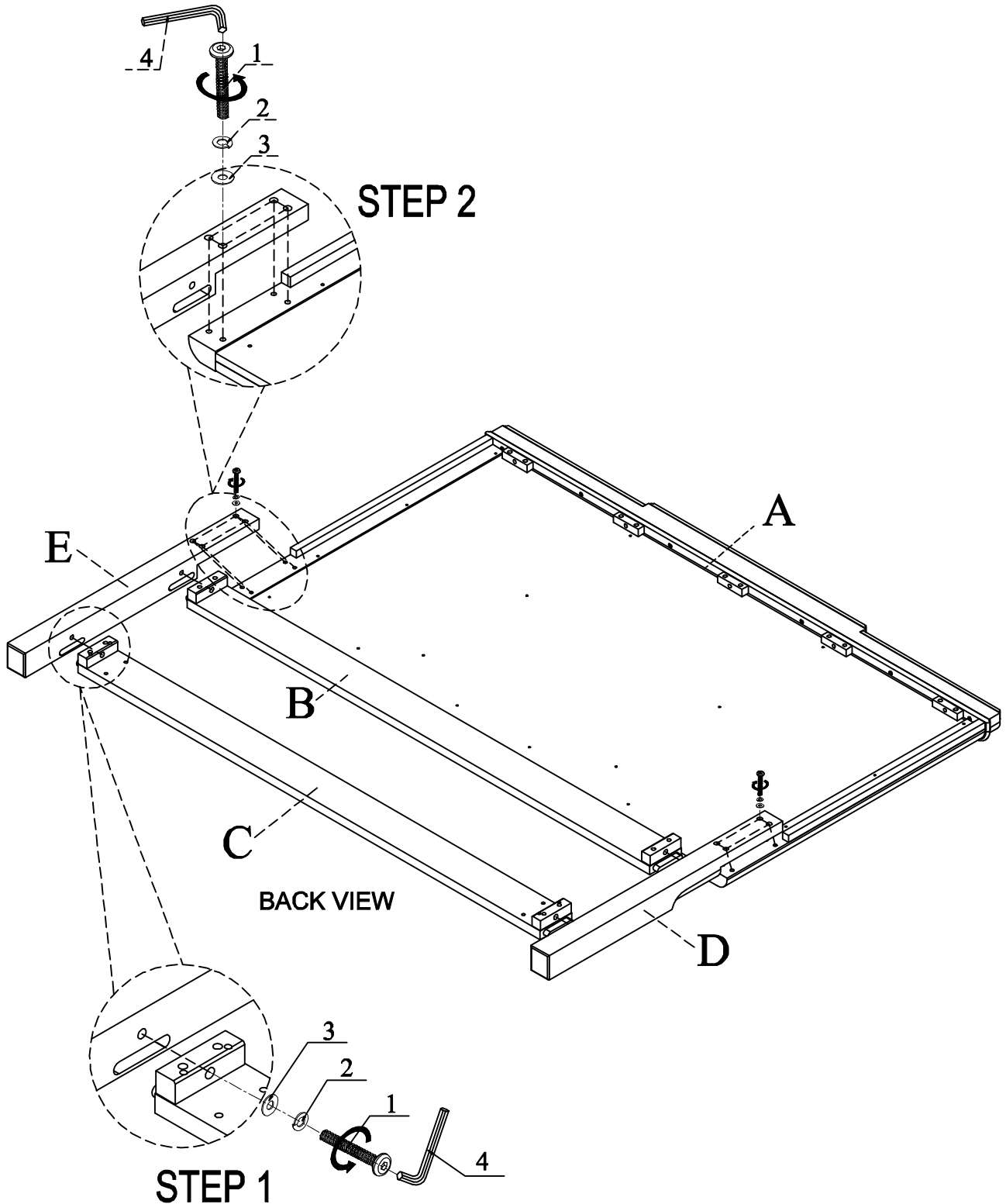

MN900QHB/MN900QFB/MN900SR ASSEMBLY INSTRUCTIONS



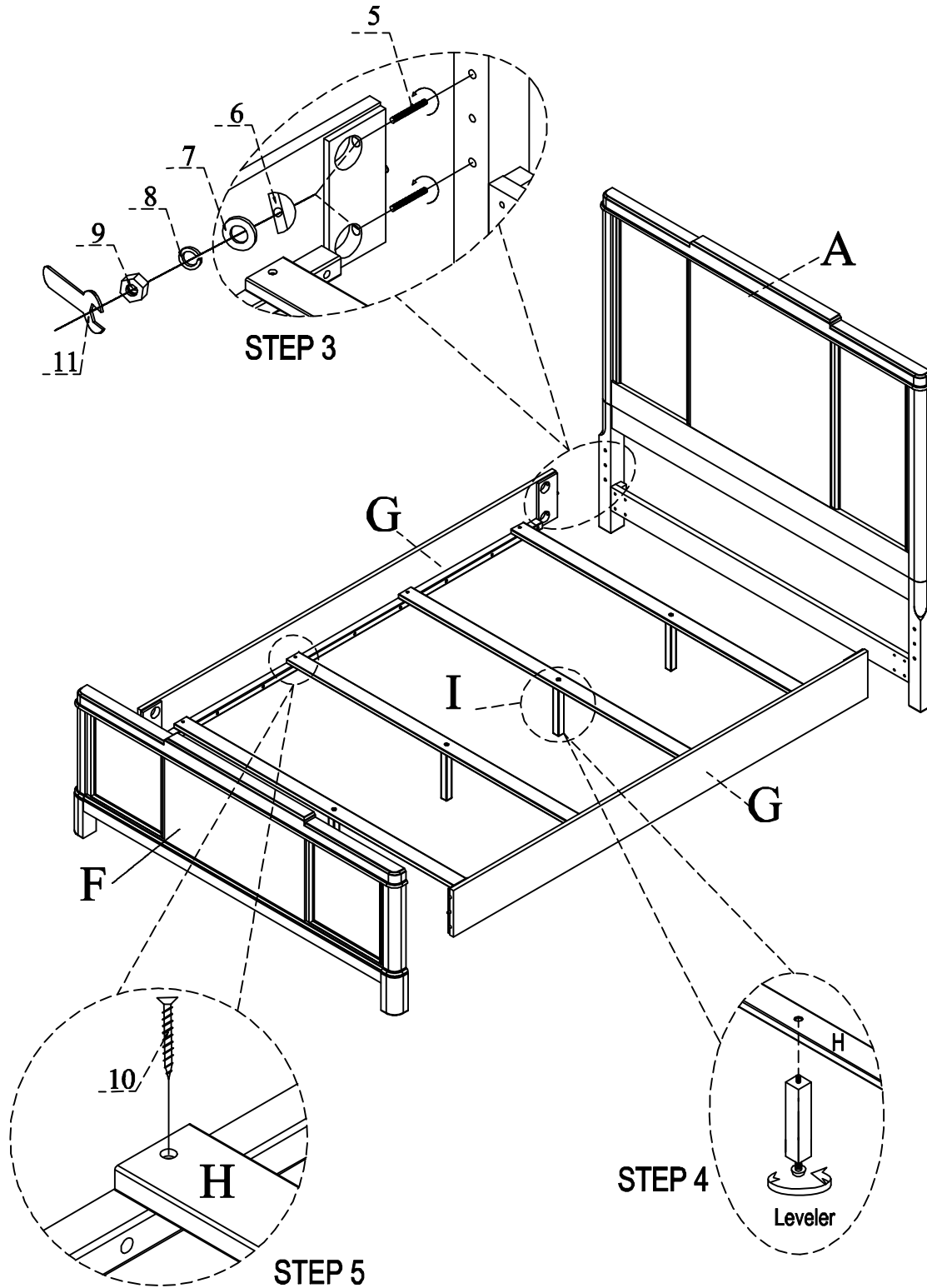

Step 3: Attach the Side rails (G) to the Headboard (A) and Footboard (F) by using Half moon washers (6), Flat Washer (7), Lock Washer (8), Hex nut (9) and Threaded rod (5) through the frame. Secure well by Wrench (1).

Step 4: Attach the Support legs (I) to the Slats (H) by twisting the bolt.



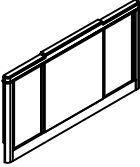
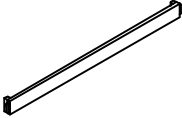
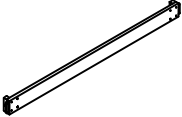

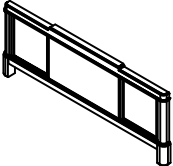
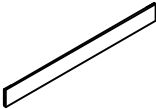

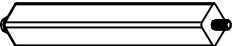

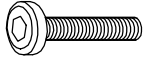
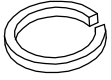

Step 5: Secure the Slats (H) into the Side rails (G) by screw (10).

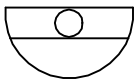

PART LIST

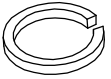
No.	Parts List		Q'ty
A		Headboard Panel	1PC
B		Top stretcher	1PC
C		Bottom stretcher	1PC
D		Left Leg	1PC
E		Right Leg	1PC
F		Footboard	1PC
G		Side rails	2PCS
H		Slats	4PCS
I		Support Legs	4PCS

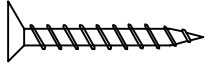
HARDWARE PACK #: PMN900QHBH/PMN900QFBH

NO.	DESCRIPTION		DIMENSION	Q'TY
1	Bolt		Ø5/16" x 57mm	12PCS
2	Lock Washer		Ø5/16" x 12mm	12PCS
3	Flat Washer		Ø5/16" x 19mm	12PCS
4	Allen Key		4*59mm	1PC
5	Threaded rod		5/16"*L89mm	8PCS
6	Half moon washers		29*15*7.5mm	8PCS
7	Flat Washer		Ø5/16" x 16mm	8PCS
8	Lock Washer		Ø5/16" x 12mm	8PCS
9	Hex nut		5/16"*12mm	8PCS
10	Wood Screw		#8 *25mm	8PCS
11	Wrench		5/16"	1PC

**PARTS FOR MN900QHB/MN900QFB/MN900SR
COMPLETE HARDWARE #: PMN900QHBH/PMN900QFBH**

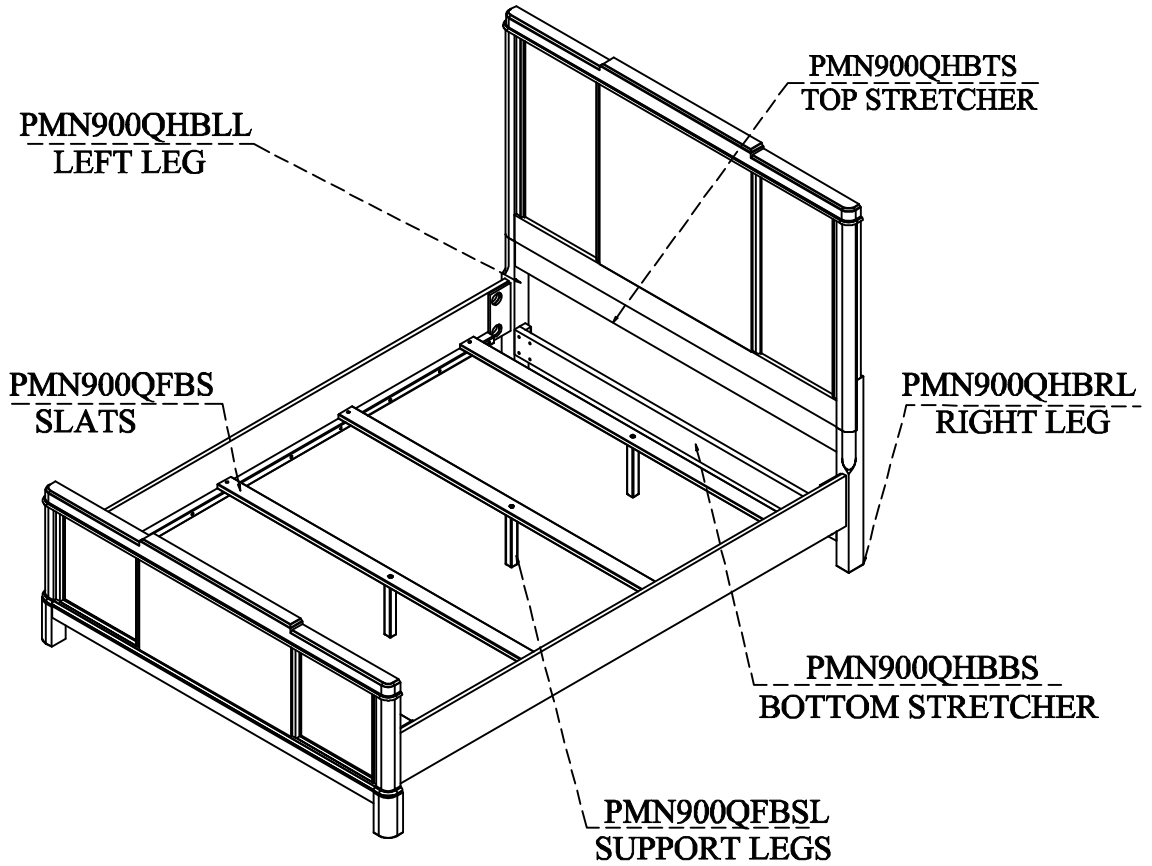

HEADBOARD PRODUCT DETAILS	
TOP LEGS	MDF/WHITE OAK VENEER
PRODUCT SIZE	RUBBER WOOD
CARTON SIZE	64.25" X 3" X 62"
NET WEIGHT	67.25" X 47.5" X 5"
GROSS WEIGHT	91.41 LBS
CU.RT.	103.73 LBS
	9.24'

FOOTBOARD PRODUCT DETAILS	
TOP LEGS	MDF/WHITE OAK VENEER
PRODUCT SIZE	RUBBER WOOD
CARTON SIZE	64.25" X 3" X 25"
NET WEIGHT	67.5" X 30.75" X 5.25"
GROSS WEIGHT	52.69 LBS
CU.RT.	62.7 LBS
	6.31'

SIDERAILS PRODUCT DETAILS	
TOP LEGS	MDF/WHITE OAK VENEER
PRODUCT SIZE	RUBBER WOOD
CARTON SIZE	82" X 2" X 8"
NET WEIGHT	86.25" X 10" X 4.5"
GROSS WEIGHT	27.06 LBS
CU.RT.	31.35 LBS
	2.25'

MADE IN VIETNAM