







Care and Maintenance

Dust with a soft, dry cloth. Do not use abrasive cleaner. To clean mirror, spray a small amount of glass cleaner onto a lint-free cloth and wipe mirror clean.

Notice

- * Please make sure that you have all parts indicated before you begin assembly of this item
- * This item should be assembled on a soft surface to prevent scratching the finish during assembly
- * This item may require periodic tightening

Part List and Hardware List

Piece	Description	Picture	Quantity
A	Thrdaded Rods		4 X
B	Iron Frame		1 X
C	Stretcher		1 X
D	Long Ribbed Tube		4 X
E	Short Ribbed Tube		4 X
F	Feet		4 X
G	Glass Top		1 X

Product Dimensions: 63"W x 16"D x 32"H

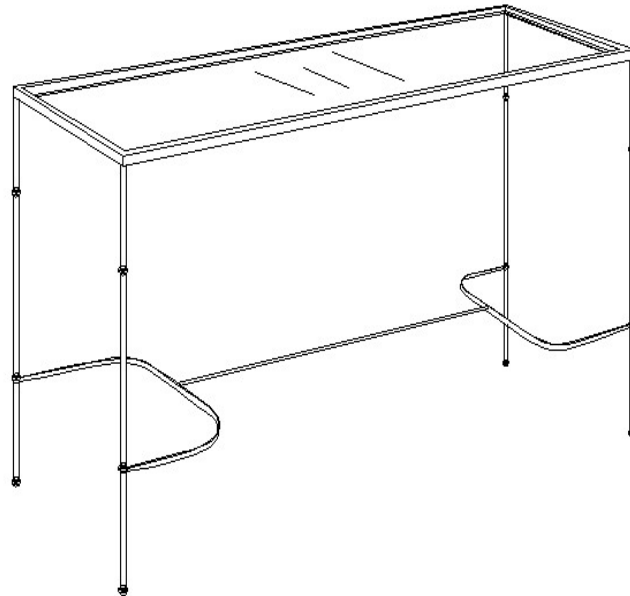

Preparation

Before beginning assembly of product, make sure all parts are present. Compare parts with package contents list and hardware contents list. If any part is missing or damaged, do not attempt to assemble the product. Estimated Assembly Time: 10 minutes.

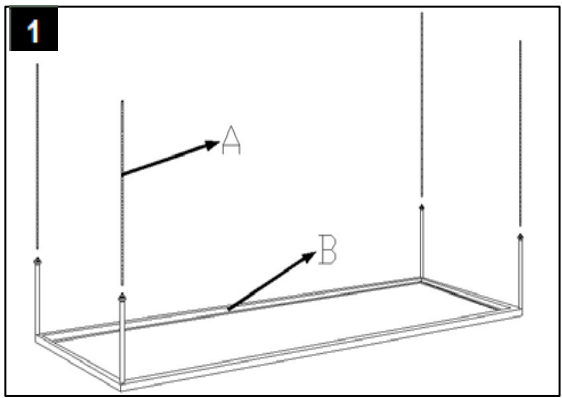

Step 1
Assemble the Thrdaded Rods(A) Iron Frame(B) together as shown in the picture.

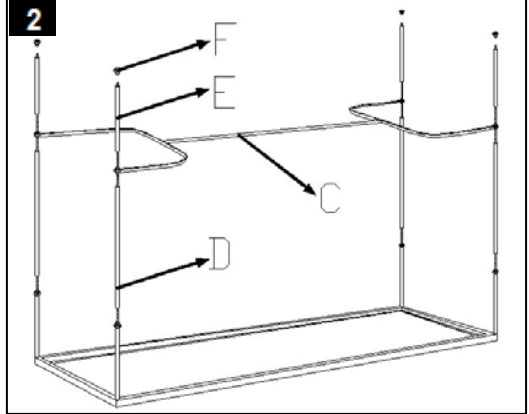

Step 2
Assemble the Thrdaded Rods(A) Long Ribbed Tube(D) Stretcher(C) Short Ribbed Tube(E) and Feet(D) together as shown in the picture.

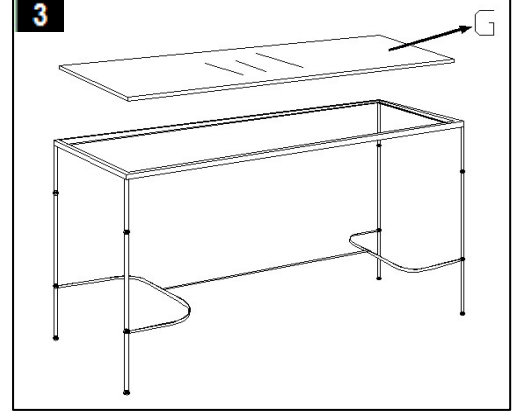

Step 3
Carefully turn over the table and place the Glass Top(G)