

Patio Swivel Set Manual



Product Description

Diverse Choices: Whether it is a family gathering, restaurant setting or daily dining, our Teslin swivel dining chair can perfectly adapt to meet your personalized needs.

Comfortable Design: The ergonomic back and seat design provide an excellent sitting experience, making your dining time more comfortable.

Sturdy Structure: Made of high-quality materials, rigorously tested to ensure long-term stability and durability, and withstand the test of daily use.

Swivel Function: The unique swivel design allows you to turn around easily and interact with family or friends without getting up, improving the convenience of dining.

Lightweight Design: The chair is lightweight and easy to carry, suitable for use in different occasions, such as restaurants, kitchens, courtyards or balconies, providing you with a comfortable sitting position at any time.

Easy to Clean: The wear-resistant surface is specially treated to resist scratches and water, which is easy to clean, keeping the chair looking like new and extending its service life.

Regular Inspection/Maintenance: Regularly check the swivel mechanism and joints of the chair to ensure that all parts are tight to extend service life and ensure safety.

Notes

Solid installation: Before assembling and using the chair, make sure all parts are tightened to avoid affecting stability.

Safe use: When using, please pay attention to the load-bearing capacity of the chair and avoid placing heavy objects on the edge of the chair to prevent tipping.

Monitor the weather: In bad weather conditions, please move the chair indoors in time to prevent damage.

Child safety: When using, please ensure that children are under adult supervision to avoid accidents.

Maintenance

Regular cleaning

Use a mild detergent and a damp cloth to wipe the surface of the chair regularly to keep it clean and shiny. Avoid using strong acid or alkaline detergents to avoid damaging the surface coating.

Deal with stains quickly

If there are food residues or liquid spills, wipe them immediately with a damp cloth to prevent the stains from drying.

Avoid direct sunlight

Try to place the chair in a place that is not exposed to direct sunlight for a long time to prevent the material from fading and deformation.

Prevent scratches

Use placemats or cloth pads, and avoid cutting or placing hot objects directly on the chair surface to prevent scratches and burns.

Regular inspection

Check the joints and screws of the chair regularly to ensure that they are tight to avoid looseness and instability. Make sure all parts are working properly and tighten or replace them if necessary.

Adjust the footrests

If you find that the chair is tilted, check the footrests and make necessary adjustments to ensure that they are stable.

Protection measures

When not in use for a long time, you can cover the chair with a dust cover to prevent dust accumulation.

ASSEMBLY STEPS

Unpack the delivery package: Unpack the Teslin swivel dining chair and make sure all parts are complete, including the seat, backrest, legs, swivel base and installation tools.

Prepare the assembly site: Choose a clean, flat place for assembly, and make sure there is enough space to accommodate the entire chair for easy operation.











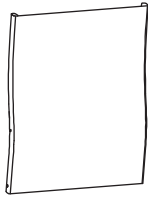
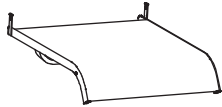

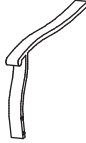



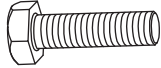
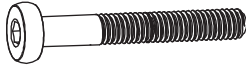
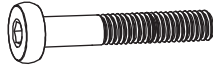

Install the chair legs: Use a screwdriver or wrench to install the chair legs to the reserved connection port of the seat. Make sure the chair legs are firmly connected to the seat to increase stability.

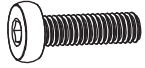
Connect the backrest: According to the diagram in the instruction manual, install the backrest to the seat and make sure all connections are tightened in place to ensure a comfortable sitting experience.

Install the swivel base: Fix the swivel base to the chair legs to ensure that the swivel mechanism is smooth and unobstructed, increasing the convenience of use.

Check stability: After installation, check all parts to make sure they are installed correctly and not loose. Gently shake the chair to confirm its stability. Retighten the screws or adjust the connection if necessary.

PRODUCT ACCESSORIES LIST

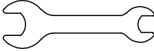
<p>A Back plate</p>  <p>4pcs</p>	<p>B Seat plate</p>  <p>4pcs</p>	<p>C Right armrest</p>  <p>4pcs</p>	<p>D Left armrest</p>  <p>4pcs</p>
<p>E Bottom ring</p>  <p>4pcs</p>	<p>F Seat front horizontal</p>  <p>4pcs</p>	<p>G TR support</p>  <p>4pcs</p>	<p>AA Compression plate</p>  <p>8pcs</p>
<p>BB Spring washer</p>  <p>16pcs</p>	<p>CC External hexagon screw</p>  <p>M8*35mm 16pcs</p>	<p>DD Flat angle screw</p>  <p>M6*70mm 8pcs</p>	<p>EE Flat angle screw</p>  <p>M6*52mm 8pcs</p>
<p>FF Flat angle screw</p>  <p>M6*30mm 8pcs</p>	<p>GG Flat angle screw</p>  <p>M6*25mm 8pcs</p>	<p>HH Gasket</p>  <p>M6 32pcs</p>	<p>II Lock nut</p>  <p>M6 24pcs</p>
<p>JJ Screw cover</p>  <p>M6 32pcs</p>	<p>KK Nut cover</p>  <p>M6 24pcs</p>	<p>LL Gasket</p>  <p>M8 16pcs</p>	<p>MM Lock nut</p>  <p>M8 16pcs</p>
<p>NN Nut cover</p>  <p>M8 32pcs</p>	<p>OO Inner hexagon wrench</p>  <p>M6 1pc</p>	<p>PP External hexagon wrench</p>  <p>M6/M8 2pcs</p>	

ASSEMBLY STEPS

Step 1: Use M8*35 to connect the seat plate and TR assembly, a total of 4 screws.

1

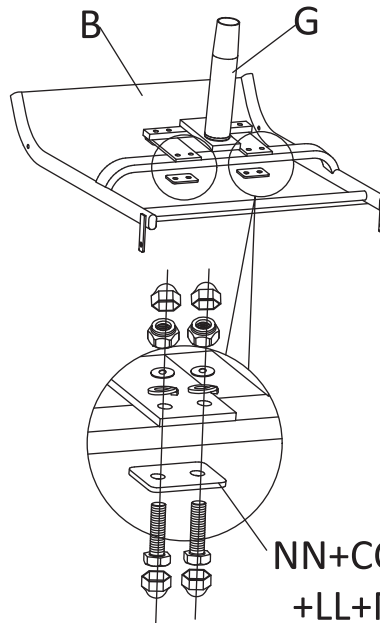

X4

AA:2PCS X4
BB:4PCS X4
CC:4PCS X4
NN:8PCS X4
LL:4PCS X4
MM:4PCS X4

Step 2: Use M6*30 to connect the seat plate and backrest, a total of 2 screws, tighten one end of the screw and then the other end, and finally tighten them at the same time.

2

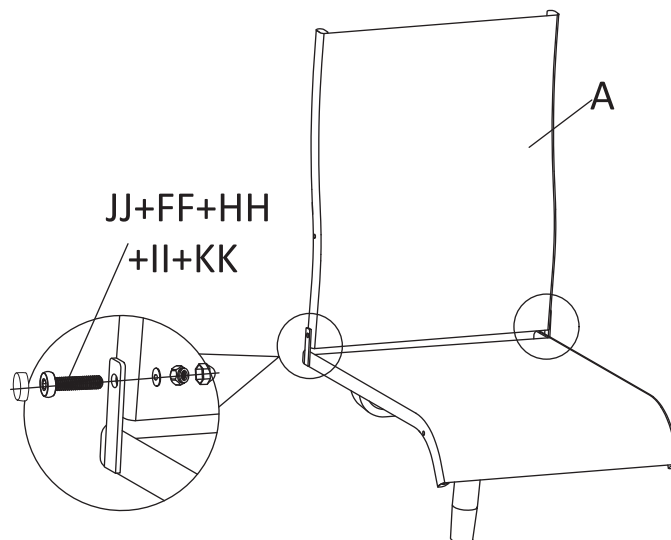

X4

JJ:2PCS X4
FF:2PCS X4
HH:2PCS X4
II:2PCS X4
KK:2PCS X4

Step 3: Connect the armrest to the front horizontal seat plate, using M6*70 on the upper side and M6*52 on the lower side, for a total of 4 screws. When assembling the upper screw holes, the front horizontal connecting piece is stuck in the middle of the armrest and the seat plate, and the screws pass through at the same time, and then assemble the lower screws.

3

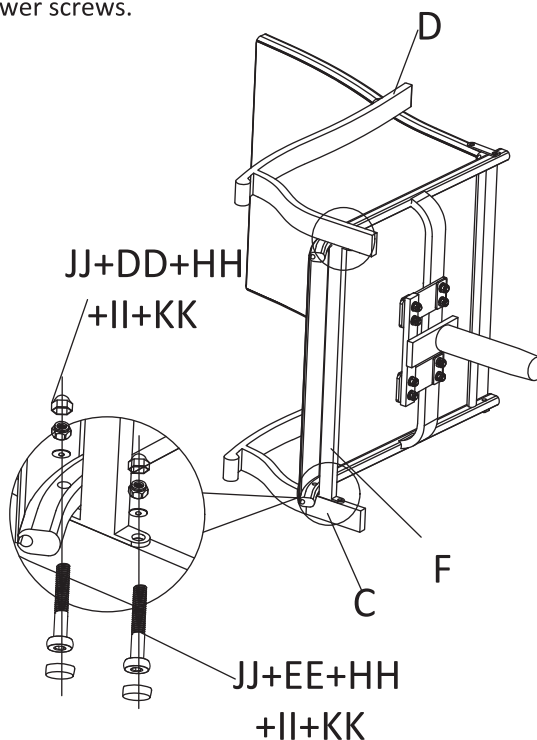

X4

- JJ:4PCS X4
- DD:2PCS X4
- HH:4PCS X4
- II:4PCS X4
- KK:4PCS X4
- EE:2PCS X4

Step 4: Connect the armrest to the backrest, using M6*25, for a total of 4 screws.

4

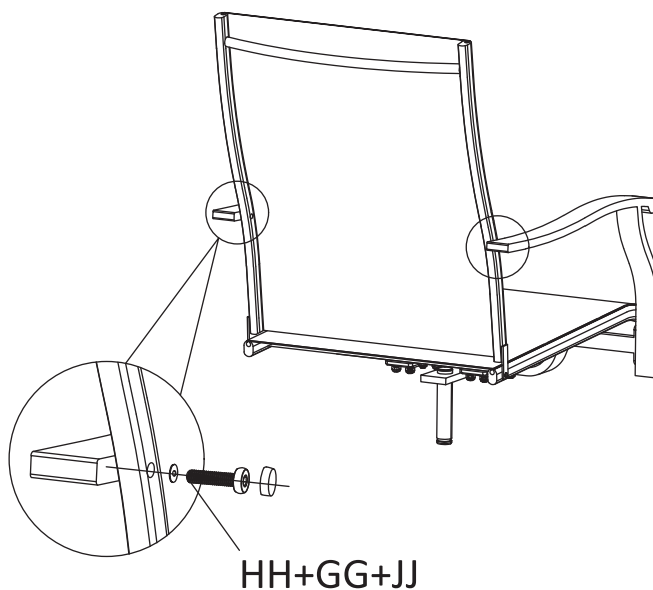

X4

- JJ:2PCS X4
- GG:2PCS X4
- HH:2PCS X4

Step 5: After completing the above steps, check whether the screws are tightened and insert the seat back frame into the base.

5

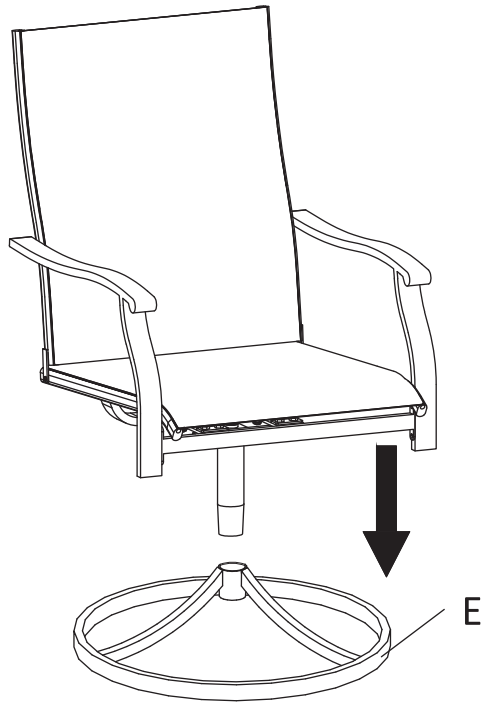

X4

E: 1PC X4

6

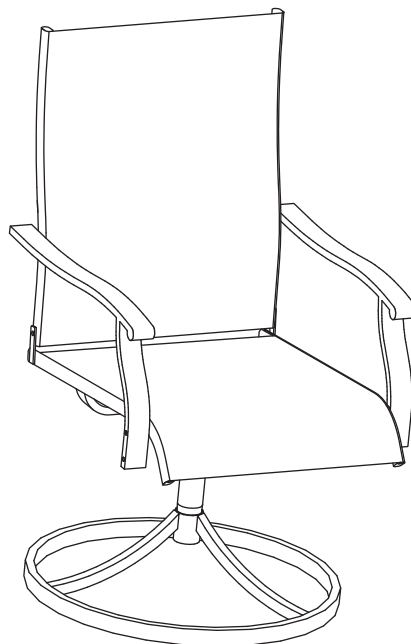

X4

Guide to using Teslin swivel chair

Choose a suitable location: Place the chair in a stable and dry place, avoid wet or slippery areas to ensure safe use.

Guide use: Before use, make sure the chair is fully unfolded and firm to attract family members or guests to use it actively.

Create a comfortable atmosphere: Place a small table, cushions or blankets next to the chair to enhance the comfort of dining or leisure.

Add fun: When you are outdoors, you can prepare some relaxing music or games to increase the fun of the party.

Clean regularly: Use a mild detergent and soft cloth to clean the chair regularly to remove dirt and water stains and keep the appearance clean and new.

Precautions

Solid installation: Before assembling and using the chair, make sure all parts are tightened to avoid affecting stability and safety.

Safe use: When using, pay attention to the surrounding environment and avoid placing heavy objects on the chair to prevent tipping or damage.

Monitor the weather: In bad weather conditions, move the chair indoors in time to prevent damage or corrosion.

Customer Service

Problem Inquiry: If you encounter any problems during use, please contact us in time and we will respond to you within 24 hours.

Feedback and Suggestions: We attach great importance to your opinions and welcome you to share your experience or suggestions with us at any time. I wish you a happy use!