

**Bathroom
Storage
Cabinet
Instruction manual**

Version 1: 2022

Before you start:

- Please check that all the parts are present before you start the assembly of your furniture. Please keep all the packaging for the product until you are satisfied with your purchase, as we cannot accept any returned items without the original packaging.
- For ease and speed of assembly, we recommend that before you commence each step you identify all the parts required for that step.
- Please ensure you have sufficient space and people to assemble your product safely.
- We recommend that, where possible, all items are assembled near to the area in which they will be placed in use, to avoid moving the product once assembled.
- For the protection of the item we recommend it is placed on a protective surface during assembly to prevent any damage.
- During assembly please take care not to over tighten any fittings as this may damage the item.

Care and Maintenance of your Furniture:

- Please periodically check all the fittings and re-tighten as necessary.
- Do not climb or stand on the item.
- Do not allow any kind of liquid to remain on the item, as over time absorption could cause the wood to warp or the finishes to fade.
- Do not drag or pull the cabinet.
- To clean the item, please use a soft cloth moistened in luke warm soapy water and buff with dry cloth.

Customer helpline:

Should you require any further assistance with the assembly of this product or require any spare parts please contact our customer care line on

01562 753040.

Or email:

sales@gablemere.co.uk

Cabinet Components

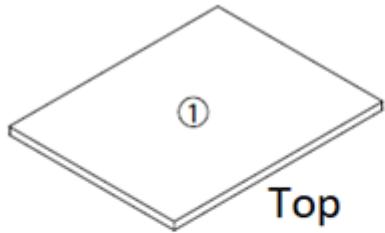

Top

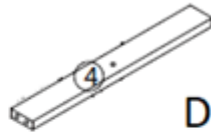

Drawer support

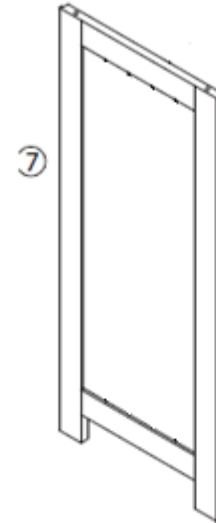

left panel

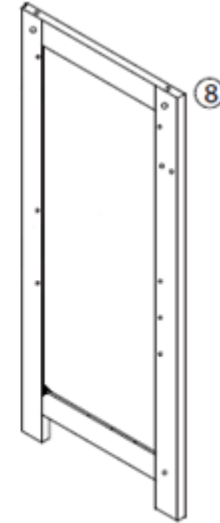

Right panel

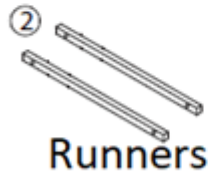

Runners

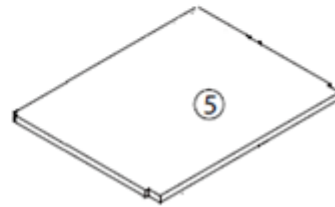

Middle shelf

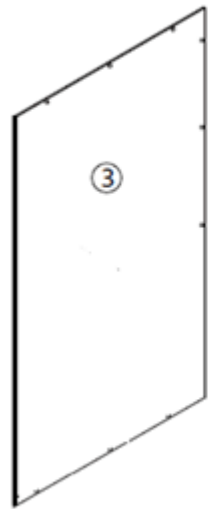

Back Panel

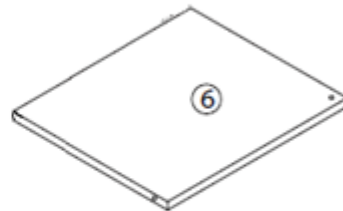

Lower shelf



Door

Drawer Components

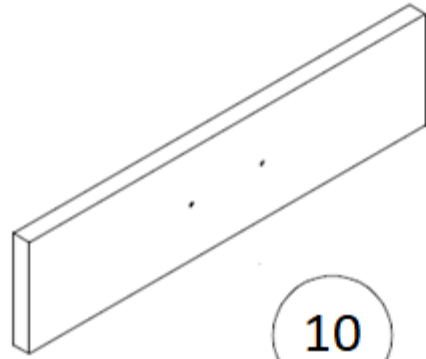

10

Drawer Front

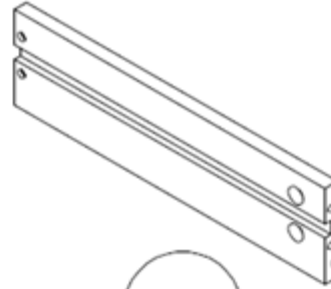

11

Left hand Drawer side

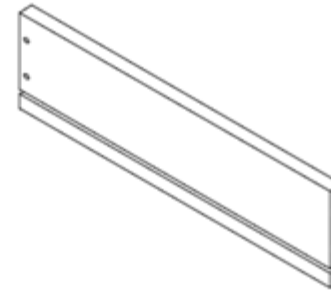

12

Right Hand Drawer side

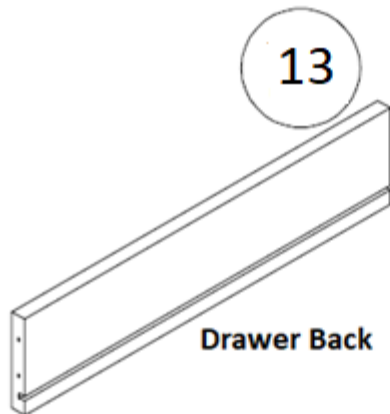

13



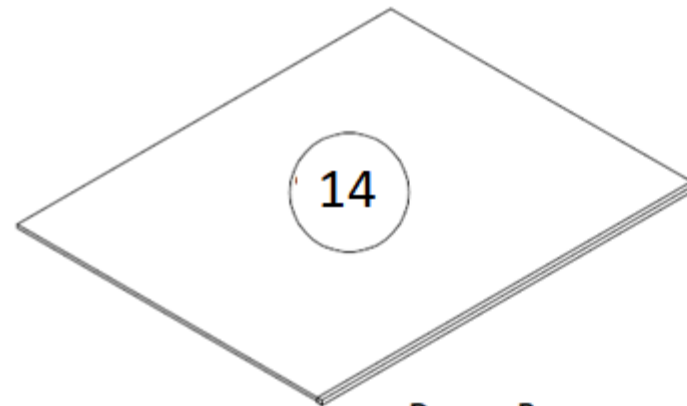











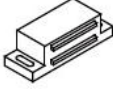



Drawer Back



14

Drawer Base

Fixings

 A x14	 B x14	 C x2	 D x4	 E x1
 F x3	 G x2	 H x1	 I x2	 J x2
 K x4	 L x2	 M x1	 N x4	 O x13
 P x1	 Q x1	 R x1	 S x1	

Instructions For Fastening CAM-BOLT and CAM-LOCK



CAM-BOLT



CAM-LOCK

CAM-BOLT

Insert Cam-bolt into the pre-drilled hole. Use a Phillips Screwdriver to tighten until shoulder is snug and flush with the panel. See illustrations below.

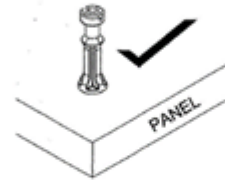

Shoulder is flush (on the same level) with the panel.

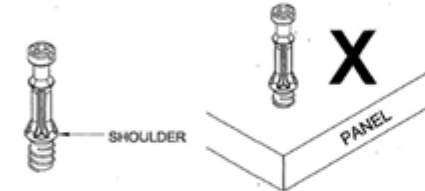

Shoulder is above the panel.

CAM-LOCK

Align the arrow on the Cam-lock to the Cam-bolt head and insert the Cam-lock.

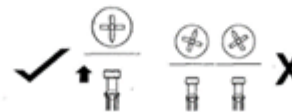

CORRECT

WRONG

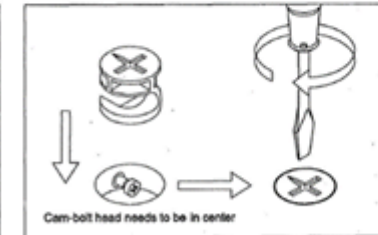

Cam-bolt head needs to be in center

Use a Flat-head Screwdriver to turn the Cam-lock clockwise one half a turn to lock onto the head of the Cam-bolt. Turn until it is snug -- over-tightening could damage Cam-lock or/and Cam-bolt

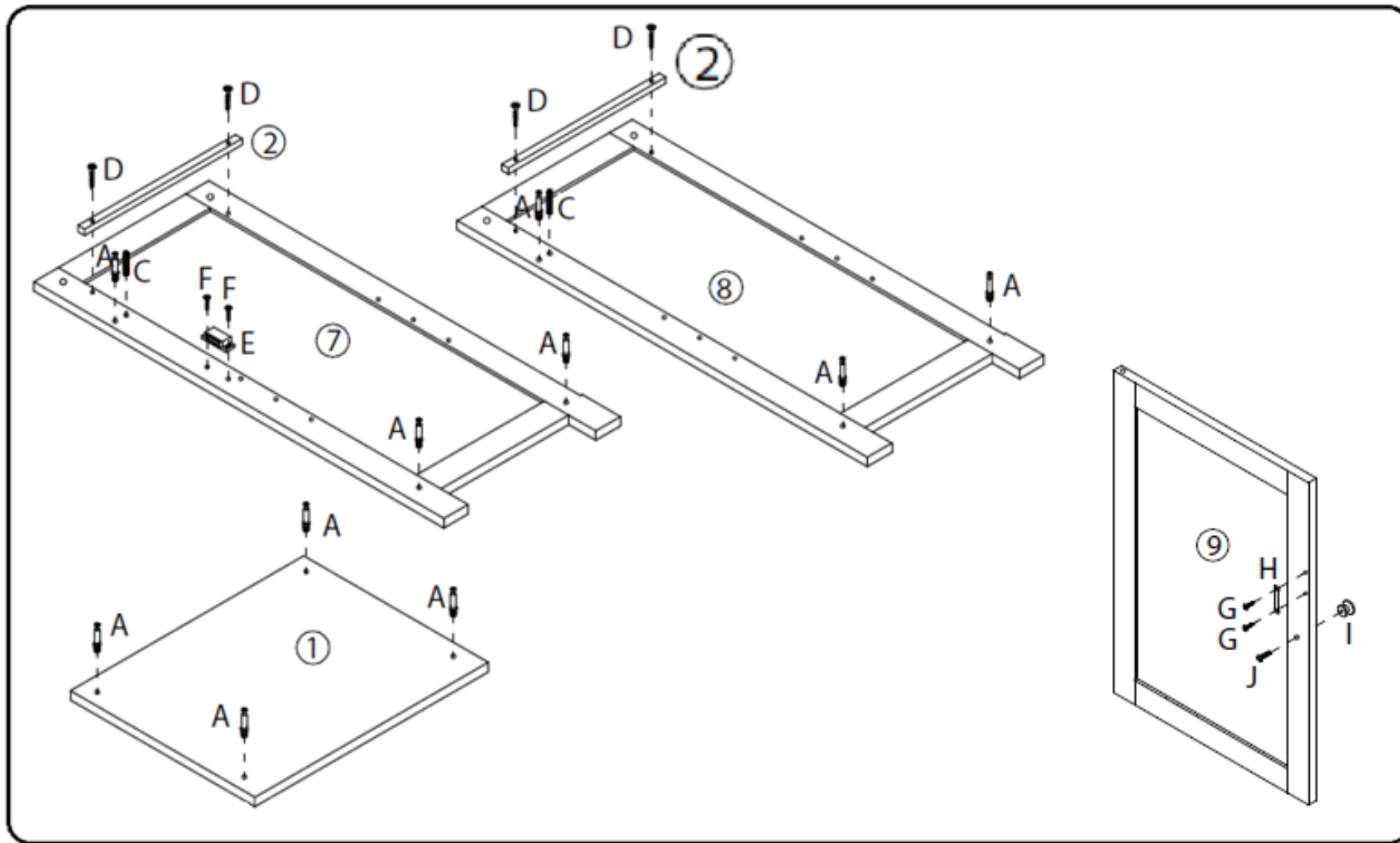

Insert all the cam bolts and other fixings into the locations on the components shown.

Drawer Construction

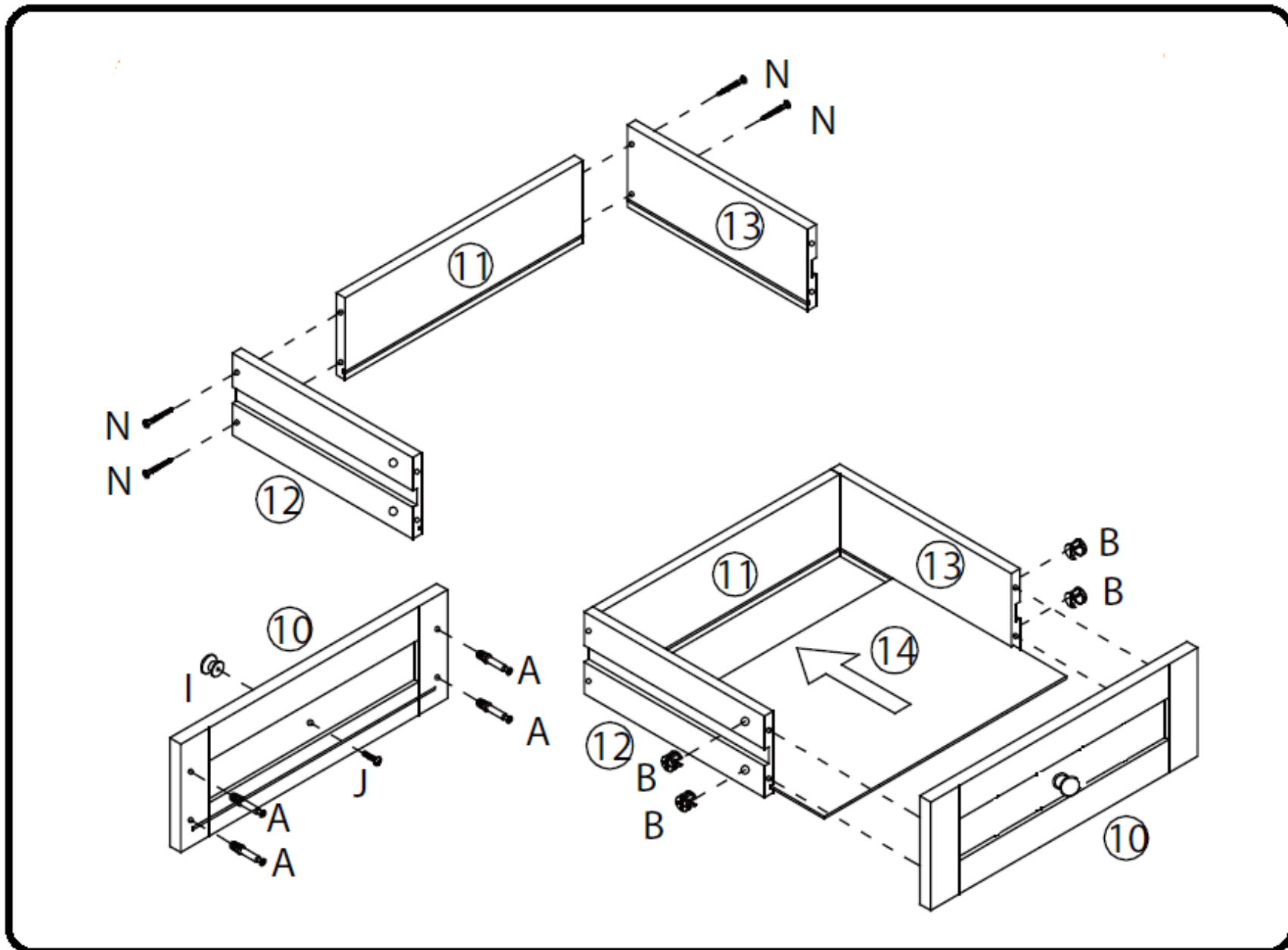

Making the cabinet

