

ODINLAKE ERGO UPGRADE

MODEL:A518

USER GUIDE

OdinLake Ergonomic Chair

Health & Stylish



Note: Thanks for purchasing from OdinLake. This manual contains important information so please keep it for further possible uses. If you have any questions that can not be solved by this manual, contact us: customers@odinlake.com

www.odinlake.com
customers@odinlake.com

Contents

General Notes	01-02
Tools List	03
Parts List	04
Assembly Instructions	05-06
Function Instructions	07-12
FAQ	13-14
Warranty	15
Office Ergonomic Guide	16
Disclaimer	17

General Notes

1. This chair is designed strictly for one person to sit on at the same time.
2. Please place the chair on the flat floor when using it.
3. Please do not let children under 6 years old sit alone on the chair.
4. Please do not sit on the armrest, it is possible to hurt oneself meanwhile cause damage to the chair.
5. Please do not stand on the chair or use it as a ladder or step.
6. Please do not put heavy objects on chairs or use them as wheelbarrows.
7. Please do not put your hand on the base mechanism except the knob & controls when using, in case of injury.
8. Please do not scratch the surface of the chair with sharp and hooked objects, and keep it away from the fire.



Tools List

A x1

Gas Lift

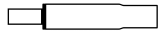

B x1

Center Base



C x5

Casters



D x1

Seat



E x2

Armrests

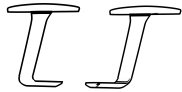

F x1

Backrest



G x1

Headrest

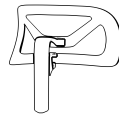

H x1

Allen Wrench



I x5

M8*30 Screws
(for backrest)



J x7

M6*30 Screws
(for armrest)



K x2

M6*25 Screws
(for headrest)



L x6

M6*15 Screws
(for base)



M x5

Leg Tubes

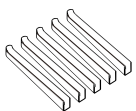

N x1

Decorative
Cover



O x1

Block



Parts List

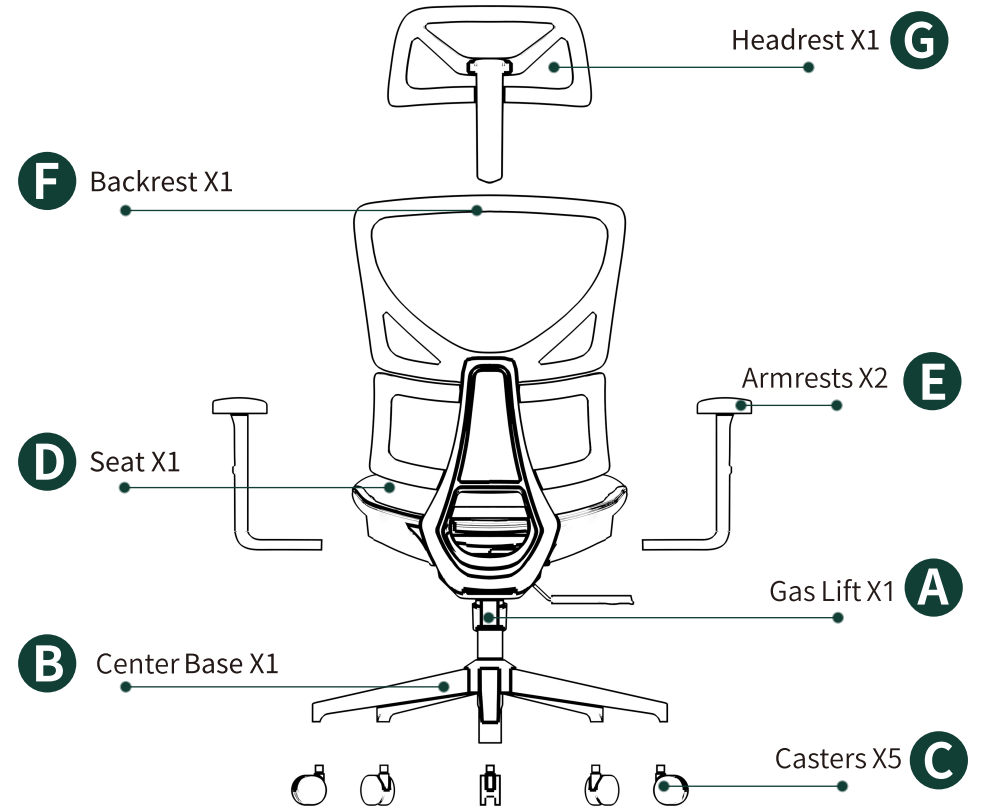

Assembly Instructions

1 First insert the Leg Tubes(M) to Center Base(B), use the Allen Wrench(H) install the 5 M6*15 Screws(L) to Center Base(B), then place the Decorative Cover(N) on the Base.

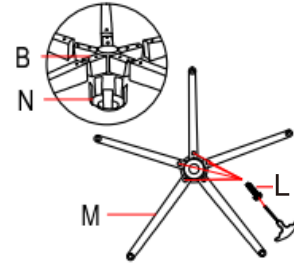

2 Insert the Casters(C) into each end of the Leg Tubes(M). Insert the Gas Lift(A) into the Base.

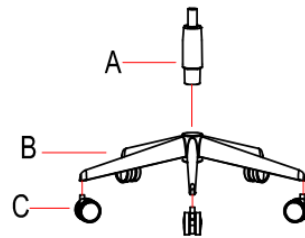

3 Install the Backrest(F) to the Seat(D) with 4 M8*30 Screws(I).

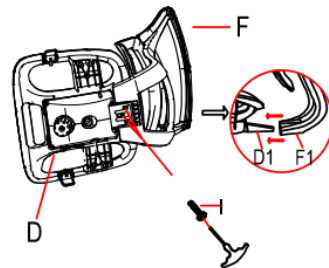

4 Install the Armrests(E) to the Seat(D) use 6 M6*30 Screws(J).

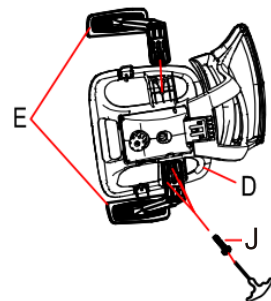

How to Assemble Your Chair Easy As Step1-7

5 Place the Seat(D) on the Gas lift(A).

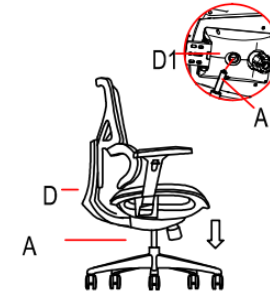

6 Use the Block(O) and 2 M6*25 Screws(K) to fix Headrest(G) to the Backrest(F).

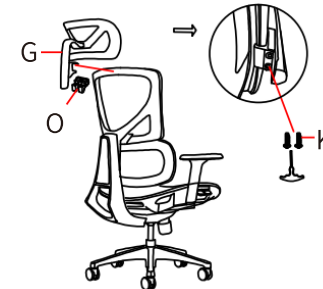

7 Finish



Function Instructions

- 1 2D Headrest
- 2 Back Lifting Adjustment
- 3 Livemotion Lumbar Auto-tracking System
- 4 3D Armrest
- 5 Seat Depth Adjustment
- 6 Seat Height Adjustment
- 7 Back Tilt & Lock Adjustment
- 8 Back Tilt Elasticity



Function Instructions

Neck Support

2D (height, tilt angle) adjustable headrest can provide multi-directional support to your neck and reduce pressure on your neck.

Shoulder Support

The radian design of the backrest provides a better support to the shoulders.

Back Support

The shape of the backrest is design based on bionic spine, which is the best solution for backpain-relase. It can provide a 100% whole-line support to your thoracic spine, lumbar spine and sacrum spine.

Lumbar Support

Livemotion lumbar system can automatically provide a full and supreior support to your lumbar area. No matter when you're moving or reclining, the lumbar support will follow your movement.

Arm Support

3D Armrest allows forearms to be supported and rested comfortably when using keyboard or mouse or reclining.

Hips Support

Intelligent seat can deliver comfortable and breathable support to avoid hips pain and hot feeling for long-time sitting

Thigh Support

Seat depth adjustment help to fit users with different heights and provide a good support. It can release the pressure on hips to contribute to body blood circulation.

Function Instructions

1D Height Vertical adjustment

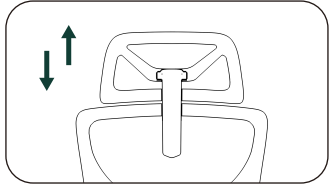

Holding both sides of headrest and pushing headrest up or down to adjust the height

2D Angle adjustment

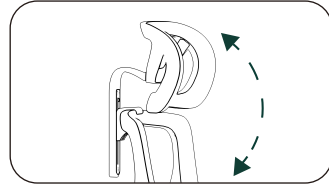

Holding two sides of the headrest and rotate forward or backward to adjust the angle

Back Lifting Adjustment

The whole backrest is adjustable upward and downward.

Hold the two sides of the backrest to adjust it upward or downward slowly to find the best lumbar position for yourself. There are 4 positions to lockdown.

Attention:

In order to adjust it more easily and safely, Please adjust the backrest upward or downward when the backrest is in the default position.

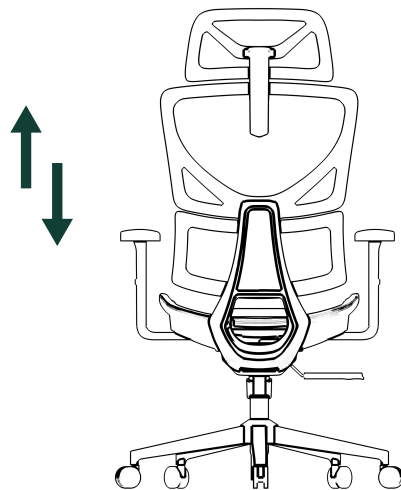

Function Instructions

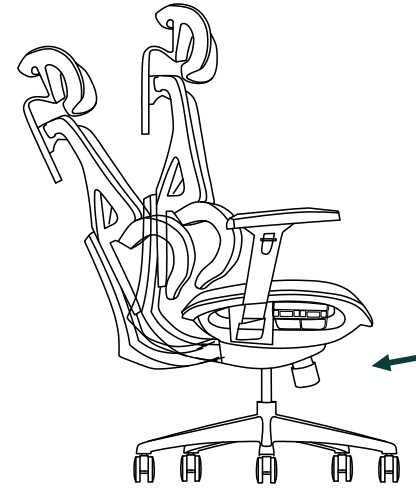

Back Tilt Tension

Rotate the adjustment lever counterclockwise to reduce backrest elasticity.

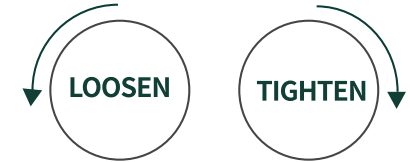

Rotate the adjustment lever clockwise to increase the backrest elasticity

Livemotion Lumbar Auto-tracking System

Delivers full support and superior comfort to touser's lumbar & sacrum area when the user changes sitting posture. Users'lumbar can be supported fully and automatically all the time in any sitting position.



Function Instructions

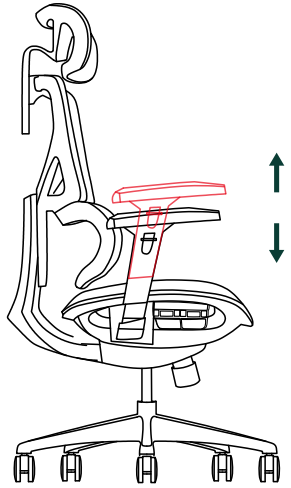

Upward & Downward

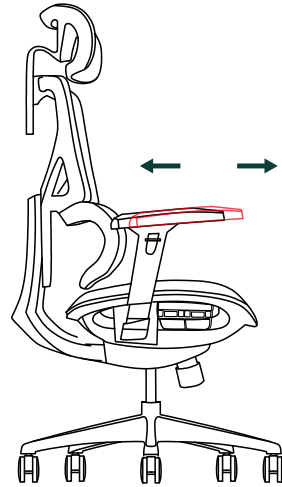

Forward & backward

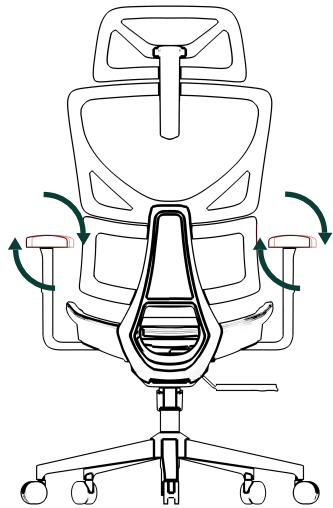

Angle adjustment

Function Instructions

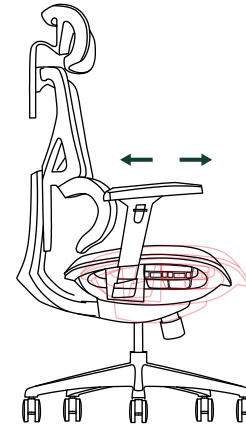

Lean on the backrest and pull up the control lever to adjust the seat forward or backward.

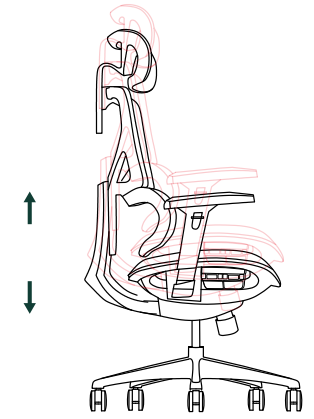

Pull up the control lever to raise or lower seat height. Release the control lever to lock seat in position.



Frequent Questions and Answers

1. How much weight can this chair support?

The maximum weight capacity is 350 lbs. In general, you will feel very comfortable if you weigh under 300 lbs. But if you feel any discomfort, please contact us for technical assistance at customers@odinlake.com.

2. How to clean the mesh office chairs?

Use a vacuum cleaner weekly to keep the mesh easily. OdinLake ergonomic chairs can be washed with warm water and mild detergent. Use a soft brush and be careful when scrubbing or the mesh fiber may break. Use cleaning solutions and cover the dirty area with a wet cloth for 30 minutes to remove the stubborn dirt.

3. How to clean the office chair wheels?

Pull off the wheels by hand or detach with a screwdriver when cleaning. Remove dirt and debris with a spray cleaner. Please be sure to dry all components thoroughly. After finishing cleaning, wheels need to be polished by greaseless lubricant to keep them operating smoothly.

Frequent Assembling Malfunction

	Malfunction	Reason	How to Fix
1	Abnormal noise	Loose or untightened bolt	Retighten all bolts
2	Crooked backrest or armrest	Crooked components during assembling	Loosen the bolts, adjust component to correct position and retighten
3	Seat can not be raised	The lift valve is closed or person sitting on the chair	Open the lift valve, do not sit on the seat while adjusting
4	Seat can not be lowered	The lift valve is closed, person not sitting on the chair or not sitting properly	Open the lift valve, make sure to sit in the center of the chair
5	Not rocking	Tilting function is locked	Pull down the adjustment lever
6	Uncomfortable rocking -strong tension	Rocking spring too tight	Adjust the back tilt tension lever clockwise until you find the best tension
7	Uncomfortable rocking-weak tension	Rocking spring too loose	Adjust the back tilt tension lever counterclockwise until you find the best tension

Warranty Rules

1. Warranty Range

We provide free replacement parts for buyers/users. Warranty only covers the parts of the chair. Please note that free tools (allen wrench) are not covered in the warranty.

2. Warranty Conditions

Parts will be covered if used normally in reference to the instructions in the manual. Warranty will not include damages caused by not following the manual.

3. No warranty covered

- 1) No proof of damaged parts (need clear original picture or video to show the defective parts of chair).
- 2) Failure parts caused by improper operation after purchase. For example, sitting on the armrest may break it.
- 3) The parts fail due to modification, disassembly or repair of the product by a third party or customer not following the instructions.
- 4) Other reasons found that cannot prove damaged parts. We shall not be responsible for any intended damages or accidental damages by detrimental weather, etc.

4. Attention

Please keep the original package box for 30 days in case you need to return the chair to the OdinLake.

Office Ergonomic Guide

A comfortable working space can help you feel better. Give your sitting and working area a makeover with this visual guideline to office ergonomics.

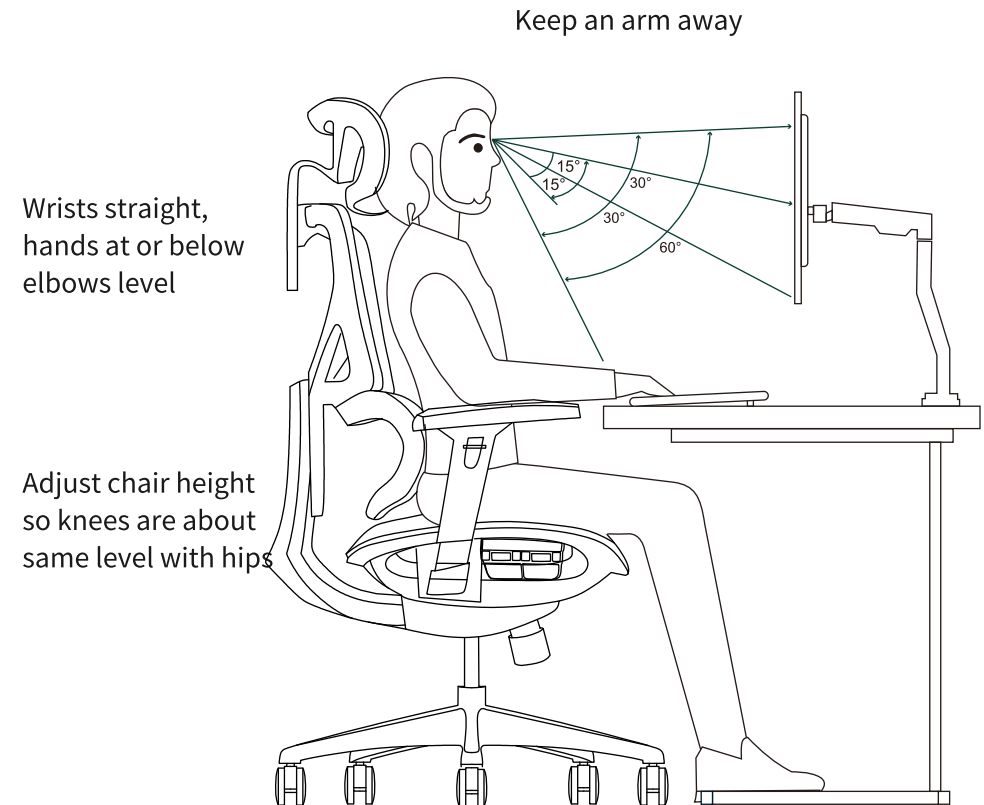

Enjoy your daily life with OdinLake Chairs!

Disclaimer



Attention: Ignoring the contents described herein may result in death or injury to the user, or there is a risk of property damage.



Please do not use or store the product in high temperature, high humidity or direct sunlight for a long time.



Please do not repair, modify or disassemble yourself unless you follow the instructions in this manual. It could cause a malfunction.



Do not use this product for infants.



Never sit on the armrest

OdinLake owns the copyright of this file.

Unauthorized reproduction/reprinting of all parts of this manual is prohibited.

Due to product improvement, the specifications and appearance of this product are subject to change without prior notice.

Please note that we are not responsible for any failure of other products caused by using this product.

OdinLake is a registered trademark in the USA, Europe and Japan.



Any Quality Issue

Please send email to customers@odinlake.com, take picture and offer your Order No. for OdinLake's easy checking.

OdinLake will provide free replacement parts, send a new chair or refund accordingly.