

Assembly Instructions Instructions de Montage

N709P300871/N709P300872

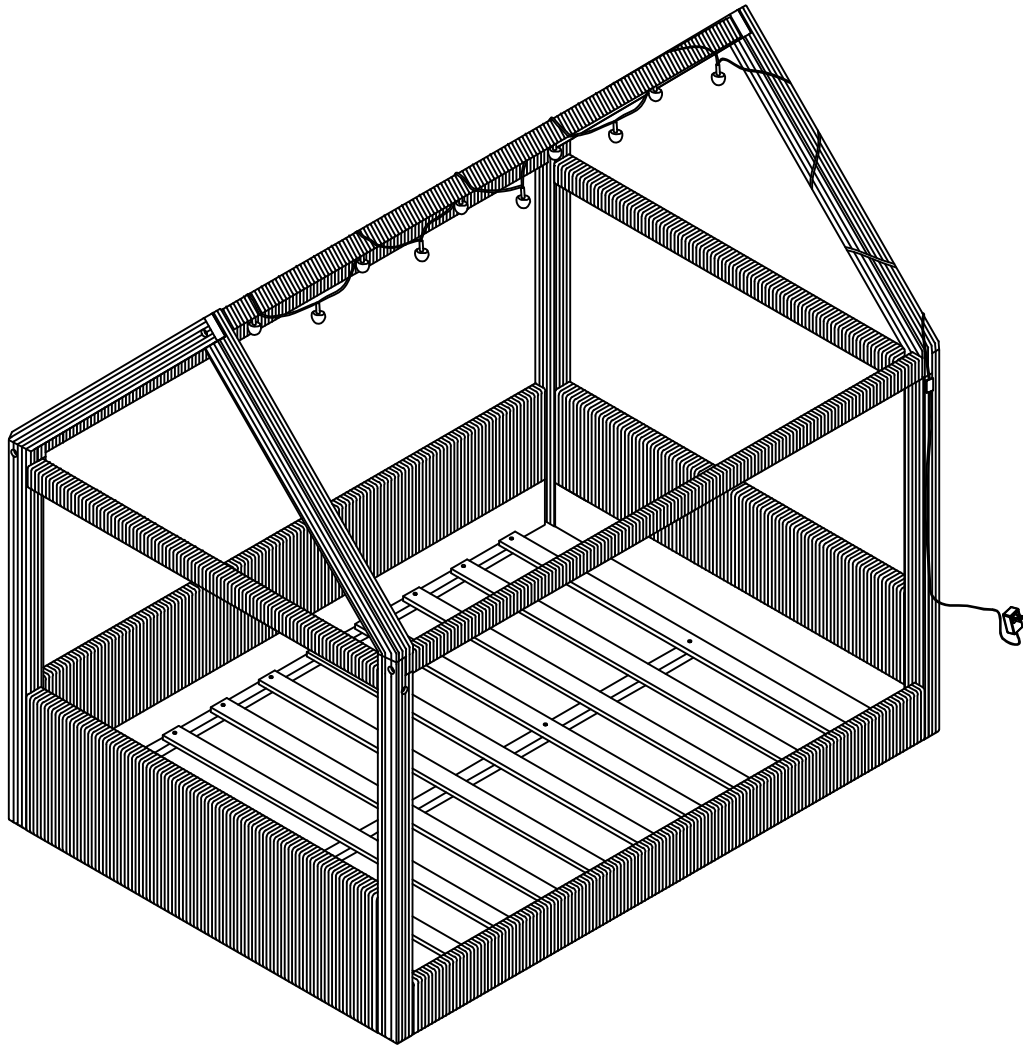

IMPORTANT NOTE

NOTE IMPORTANTE

****PLACE ALL PARTS ON A CLEAN AND SMOOTH SURFACE SUCH AS A RUG OR CARPET TO
PLACEZ TOUTES LES PIÈCES SUR UNE SURFACE PROPRE ET LISSE COMME UN TAPIS OU UN TAPIS POUR**

AVOID THE PARTS FROM BEING SCRATCHED

ÉVITER LES PIÈCES D'ÊTRE RAYÉES

**** BEFORE YOU BEGIN , KINDY FOLLOW THE ASSEMBLY INSTRUCTIONS STEP BY STEP**

AVANT DE COMMENCER, KINDY SUIVEZ LES INSTRUCTIONS DE MONTAGE ÉTAPE PAR ÉTAPE

****DO NOT TIGHTEN ALL SCREWS AND BOLTS UNTIL THE BED IS FULLY SET-UP**

NE SERREZ PAS TOUS LES VIS ET BOULONS JUSQU'À CE QUE LE LIT SOIT COMPLÈTEMENT INSTALLÉ

Assembly Instructions Instructions de Montage



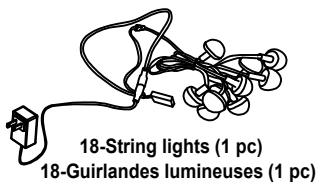
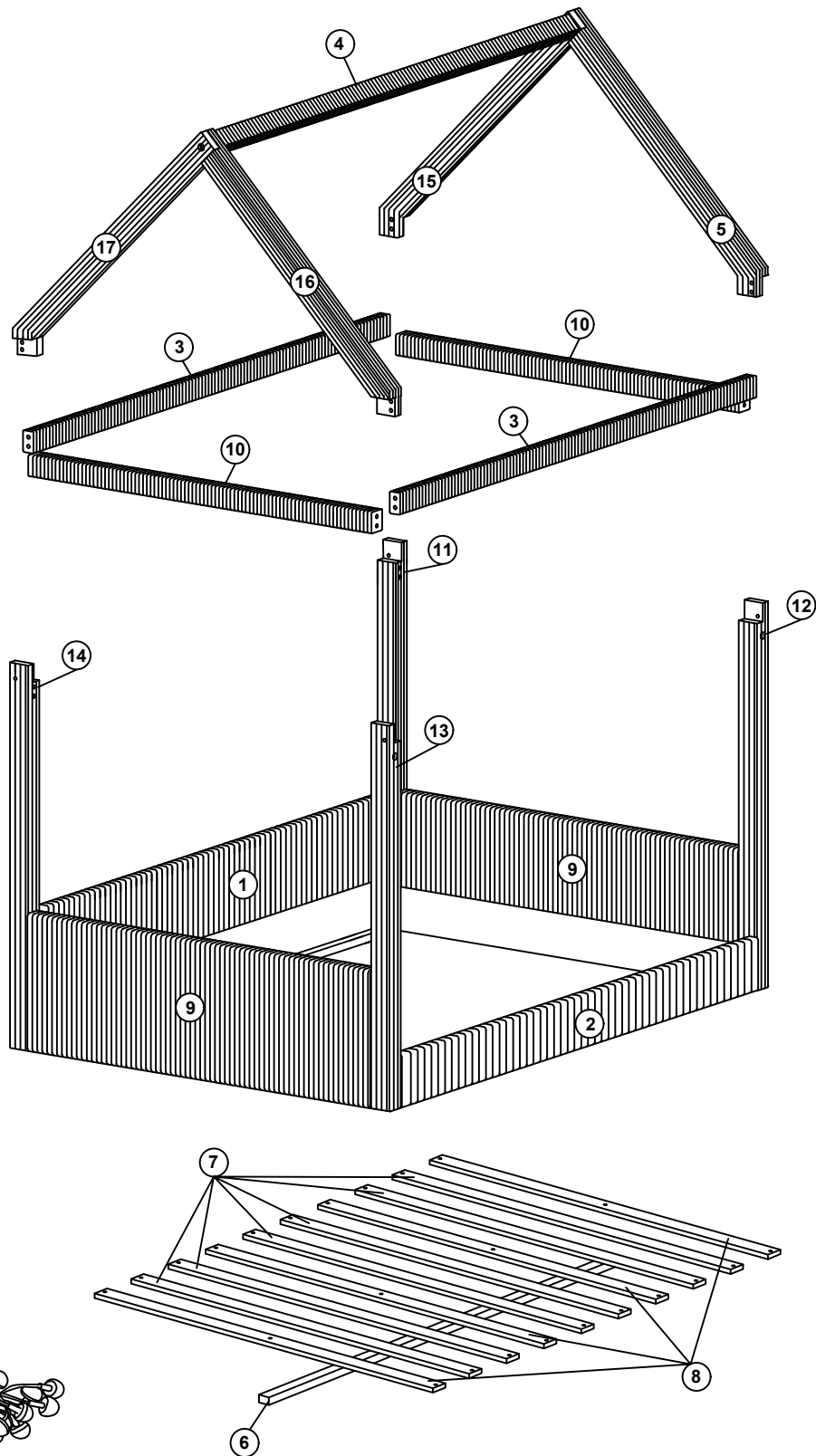



N709P300871/N709P300872







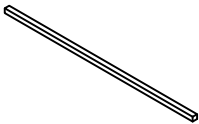
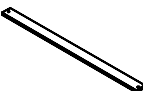

Assembly Instructions Instructions de Montage

N709P300871/N709P300872

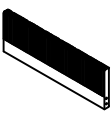
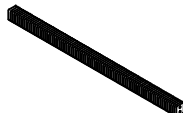
PAST LIST BOX 1 N709P300871 LISTE PASSÉE BOÎTE 1 N709P300871

<p>1</p>  <p>Back Side Rail (1 pc) Rail latéral arrière (1 pc)</p>	<p>2</p>  <p>Front Side Rail (1 pc) Rail latéral avant (1 pc)</p>	<p>3</p>  <p>House Back/ Front Rail (2 pcs) Rail arrière/avant de la maison(2 pcs)</p>
<p>4</p>  <p>House Middle Rail(1 pc) Chambre Rail du Milieu(1 pc)</p>	<p>5</p>  <p>House Front Right Rail (1 pc) Rail avant droit de la maison (1 pc)</p>	<p>6</p>  <p>Center Rail (1 pc) Rail central (1 pc)</p>
<p>7</p>  <p>Roll Slat (6 pcs) Latte roulante (6 pcs)</p>	<p>8</p>  <p>Roll Slat (4 pcs) Latte roulante (4 pcs)</p>	

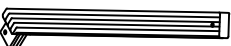

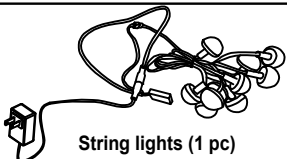
PAST LIST BOX 2 N709P300872 LISTE PASSÉE BOÎTE 2 N709P300872

<p>9</p>  <p>Headboard/Footboard (2 pcs) Tête de lit/Pied de lit (2 pcs)</p>	<p>10</p>  <p>Headboard/Footboard Horizontal Column (2 pcs) Tête de lit/Pied de lit Colonne horizontale (2 pcs)</p>	<p>11</p>  <p>Headboard Back Post (1 pc) Poteau arrière de la tête de lit(1 pc)</p>
<p>12</p>  <p>Headboard Front Post (1 pc) Poteau arrière de la tête de lit (1 pc)</p>	<p>13</p>  <p>Footboard Front Post (1 pc) Poteau avant du marchepied (1 pc)</p>	<p>14</p>  <p>Footboard Back Post (1 pc) Poteau avant du marchepied (1 pc)</p>
<p>15</p>  <p>House Back Right Rail (1 pc) Rail arrière droit de la maison (1 pc)</p>	<p>16</p>  <p>House Front Left Rail(1 pc) Rail avant gauche de la maison(1 pc)</p>	<p>17</p>  <p>House Back Left Rail (1 pc) Rail arrière gauche de la maison (1 pc)</p>
<p>18</p>  <p>String lights (1 pc) Guirlandes lumineuses (1 pc)</p>		

Assembly Instructions Instructions de Montage

N709P300871/N709P300872

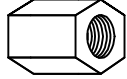
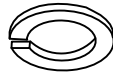
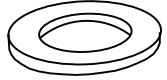
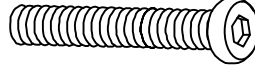
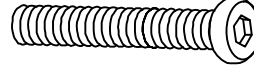
HARDWARE LIST N709P300871 LISTE DU MATÉRIEL N709P300871

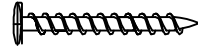
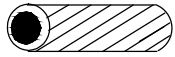
<p>A</p>  <p>Thread Bolt (16pcs) Boulon de fer (16pcs) (Ø 5/16 "X90mm)</p>	<p>B</p>  <p>Hex Nut (16pcs) Écrou hexagonal (16pcs)</p>	<p>C</p>  <p>Spring Washer (30pcs) Rondelle à ressort (30pcs)</p>
<p>D</p>  <p>Flat Washer (30pcs) Rondelle plate (30pcs)</p>	<p>E</p>  <p>Long Bolt (10pcs) Boulon long (10pcs) (Ø 5/16 "X90mm)</p>	<p>F</p>  <p>Long Bolt (4pcs) Boulon long (4pcs) (Ø 5/16 "X50mm)</p>
<p>G</p>  <p>Open Wrench (1pc) Clé à molette (1pc)</p>	<p>H</p>  <p>Allen Wrench (1pc) Clé Allen (1pc) (M4x75mm x32mm)</p>	<p>I</p>  <p>Flat Head Screw (24pcs) Vis à tête plate moyenne (24pcs) (m4x30mm)</p>
<p>J</p>  <p>Wood Dowel (4pcs) Cheville en bois (4pcs) (40mm)</p>		

Assembly Instructions Instructions de Montage



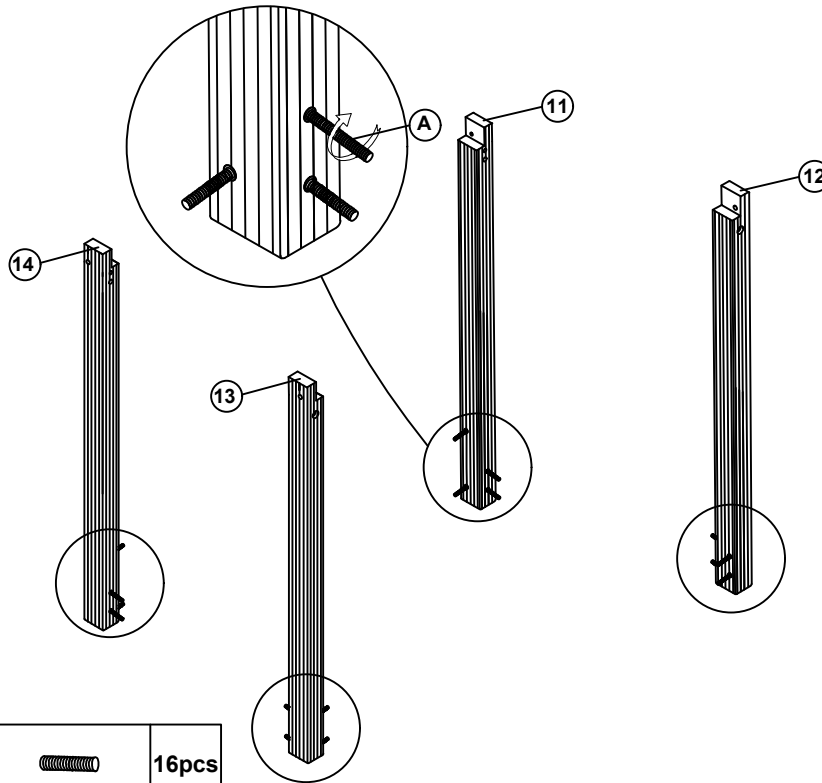

STEP 1 Étape 1

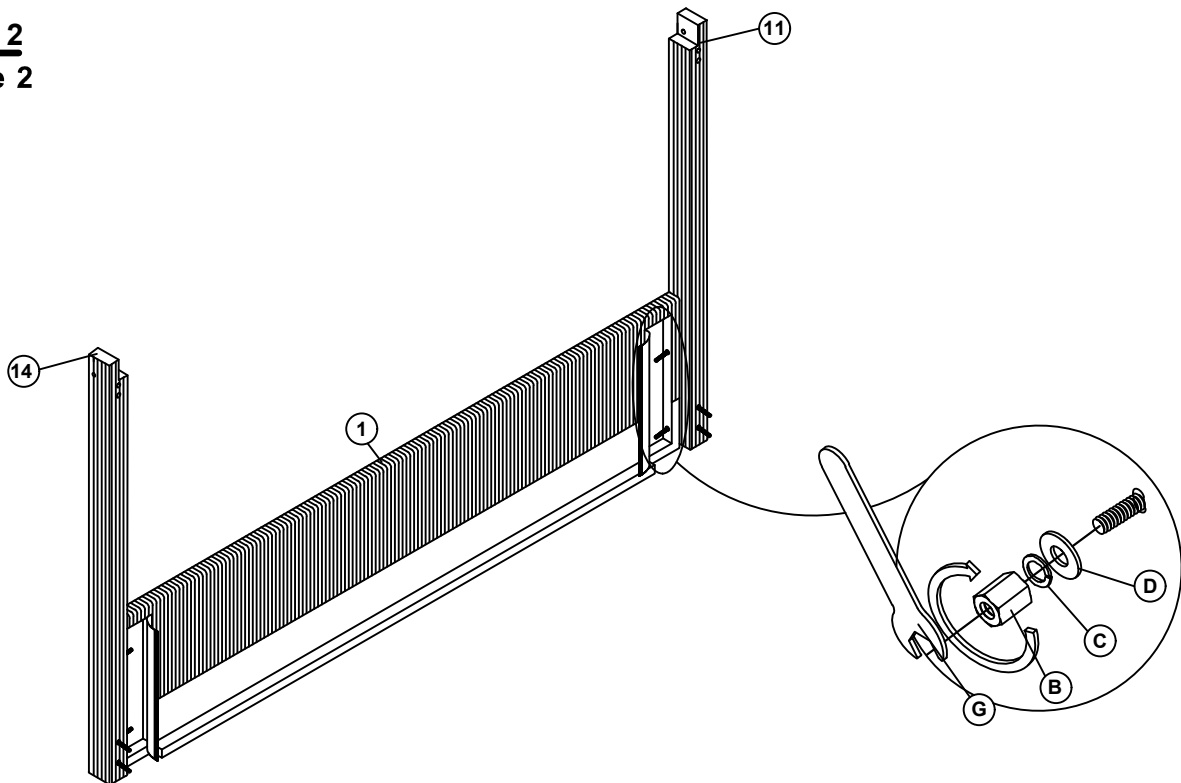

A	Thread Bolt Boulon de fer (Ø 5/16 "X90mm)		16pcs
----------	---	---	-------

STEP 2 Étape 2



B	Hex Nut Écrou hexagonal		4pcs	D	Flat Washer Rondelle plate		4pcs
C	Spring Washer Rondelle à ressort		4pcs	G	Open Wrench Clé à molette		1pc





MADE IN VIETNAM
FABRIQUÉ AU VIETNAM

PAGE 5 OF 9
PAGE 5 DE 9

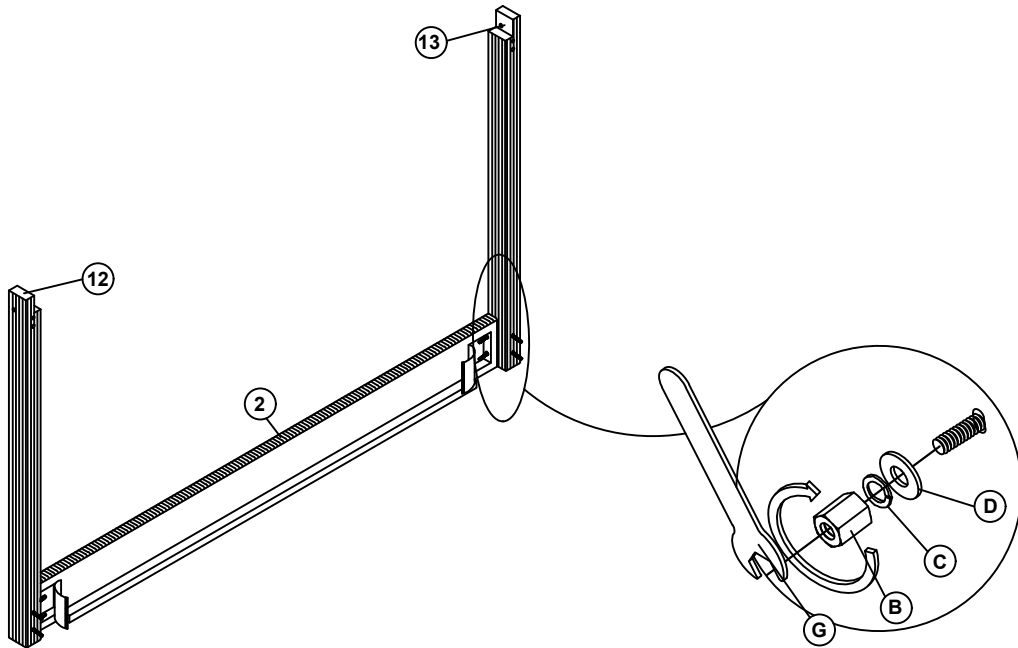
Assembly Instructions Instructions de Montage





STEP 3 Étape 3

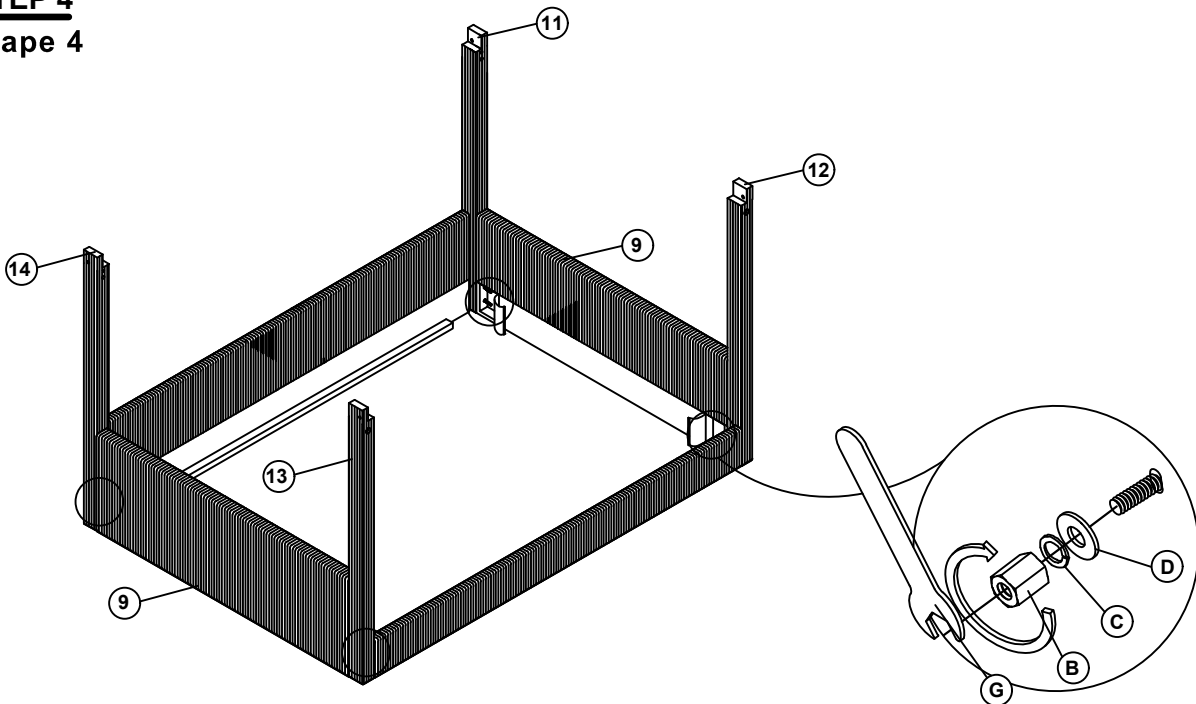

B	Hex Nut Écrou hexagonal		4pcs	D	Flat Washer Rondelle plate		4pcs
C	Spring Washer Rondelle à ressort		4pcs	G	Open Wrench Clé à molette		1pc

STEP 4 Étape 4



B	Hex Nut Écrou hexagonal		8pcs	D	Flat Washer Rondelle plate		8pcs
C	Spring Washer Rondelle à ressort		8pcs	G	Open Wrench Clé à molette		1pc





MADE IN VIETNAM
FABRIQUÉ AU VIETNAM

PAGE 6 OF 9
PAGE 6 DE 9

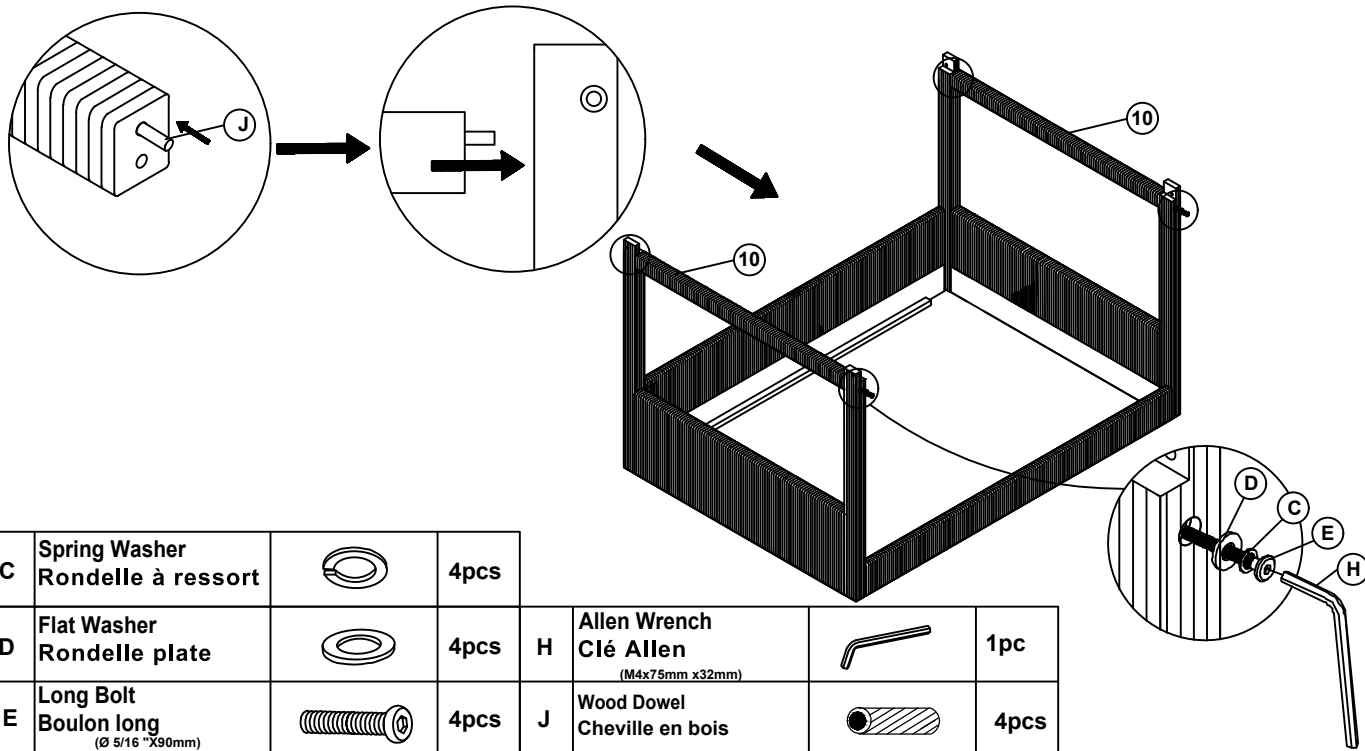
Assembly Instructions Instructions de Montage





STEP 5 Étape 5

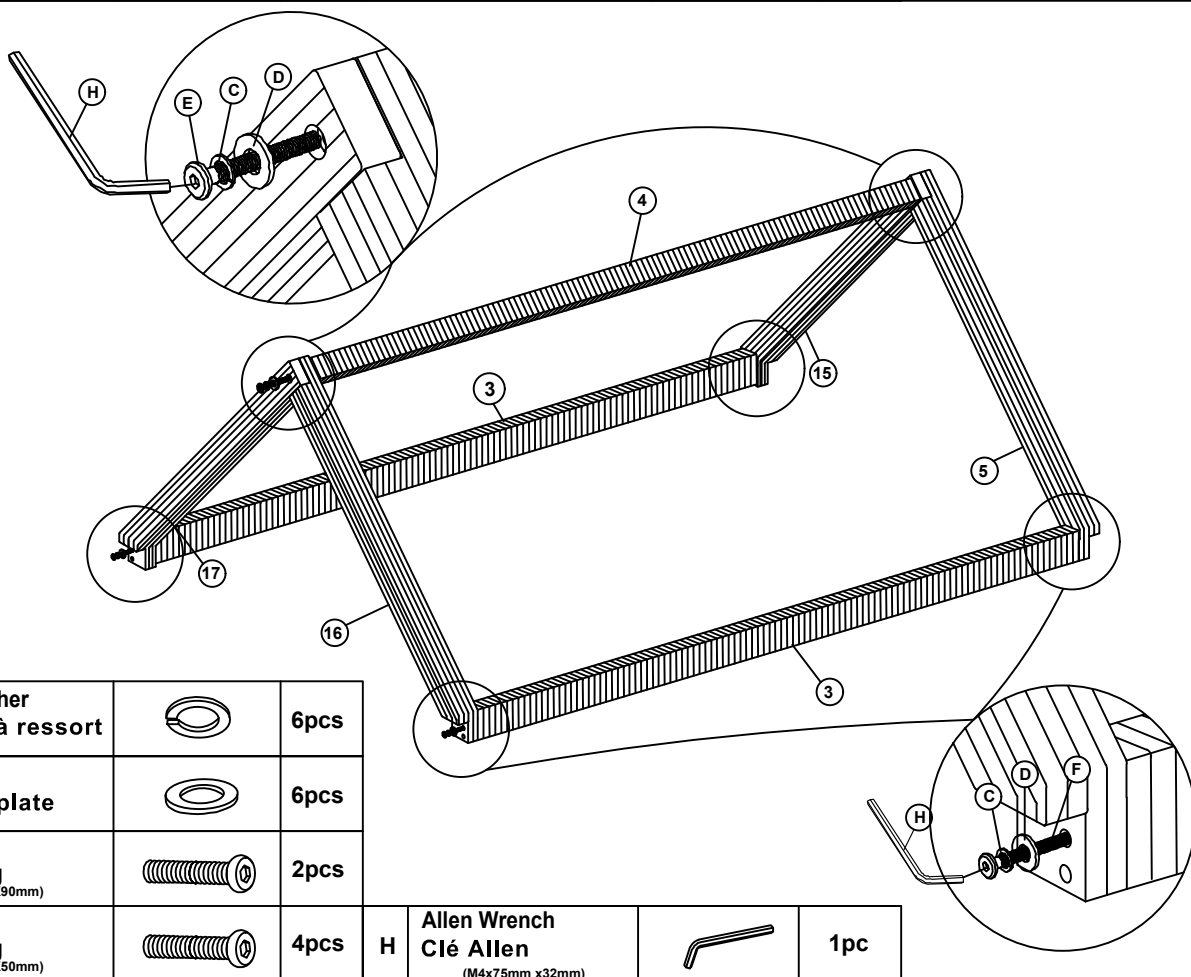

C	Spring Washer Rondelle à ressort		4pcs			
D	Flat Washer Rondelle plate		4pcs	H	Allen Wrench Clé Allen (M4x75mm x32mm)	 1pc
E	Long Bolt Boulon long (Ø 5/16" X90mm)		4pcs	J	Wood Dowel Cheville en bois	 4pcs

STEP 6 Étape 6

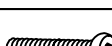
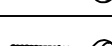



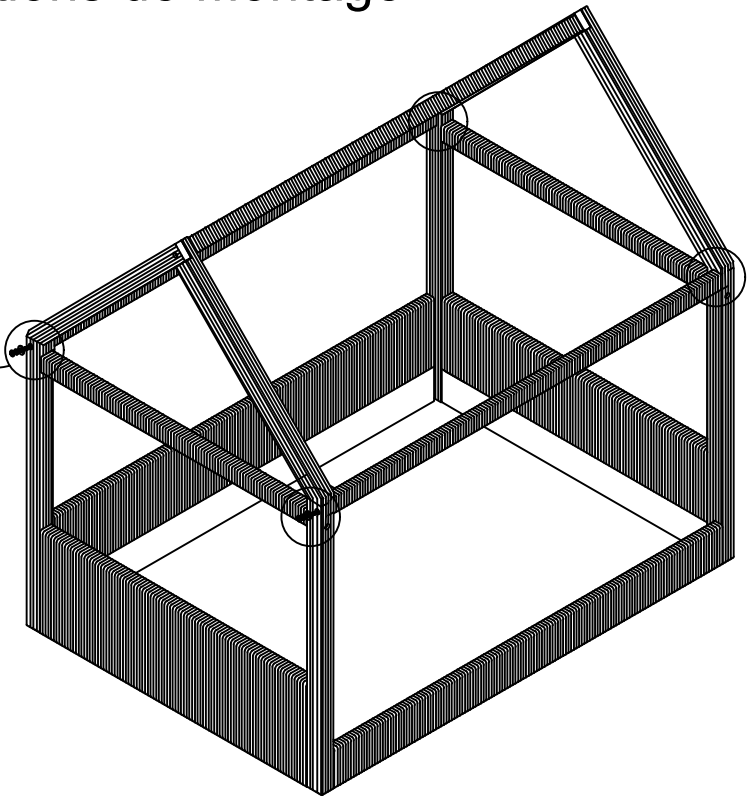
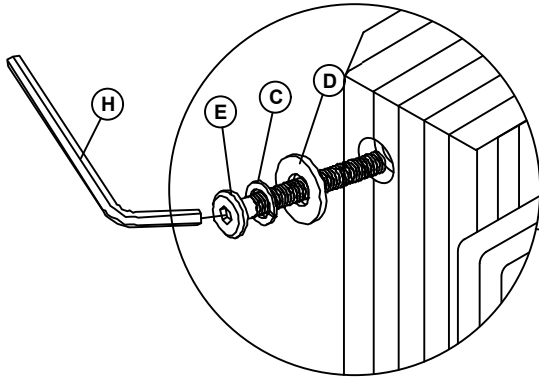

C	Spring Washer Rondelle à ressort		6pcs			
D	Flat Washer Rondelle plate		6pcs			
E	Long Bolt Boulon long (Ø 5/16" X90mm)		2pcs			
F	Long Bolt Boulon long (Ø 5/16" X50mm)		4pcs	H	Allen Wrench Clé Allen (M4x75mm x32mm)	 1pc

Assembly Instructions Instructions de Montage

STEP 7 Étape 7



C	Spring Washer Rondelle à ressort		4pcs
D	Flat Washer Rondelle plate		4pcs
E	Long Bolt Boulon long (Ø 5/16 "X90mm)		4pcs
H	Allen Wrench Clé Allen (M4x75mm x32mm)		1pc

STEP 8 Étape 8

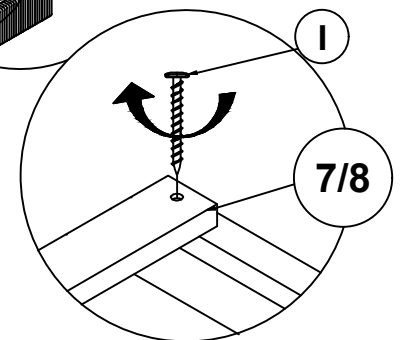
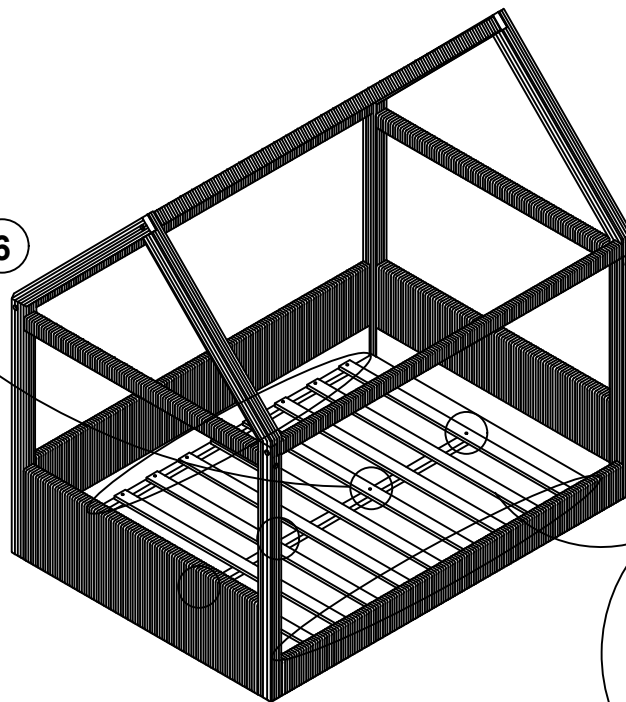
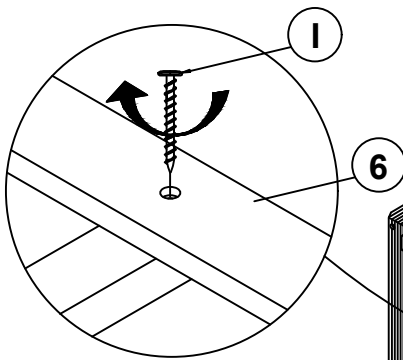

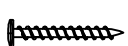
I	Flat Head Screw Vis à tête plate moyenne (m4x30mm)		24pcs
---	--	---	-------

MADE IN VIETNAM
FABRIQUÉ AU VIETNAM

PAGE 8 OF 9
PAGE 8 DE 9

Assembly Instructions Instructions de Montage

STEP 9 Étape 9

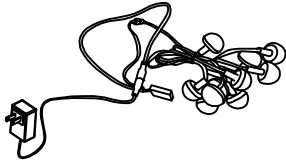

String lights can be used any way you like.
Les guirlandes lumineuses peuvent être utilisées
comme vous le souhaitez.

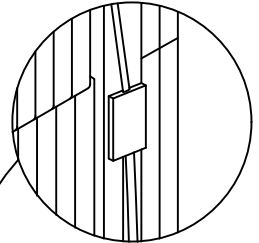

Touch to turn on/off the light and
change the LED light mode
Touchez pour allumer/éteindre la
lumière et changer le mode
d'éclairage LED

