











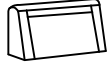

ASSEMBLY INSTRUCTION

Sofa is packed in 2 Carton

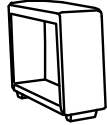
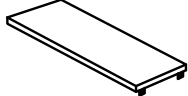
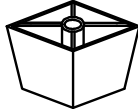
Carton	Disignation		Part	
SOFA	Loveseat	A		1pc
	Sofa back	B		1pc
	Chaise back	C		1pc
	Back Cushion	D		1pc
	Arm rest	E		1pc
CHAISE	CHAISE	F		1pc
	Back Cushion	D		1pc
	Back Cushion	H		1pc
	Arm rest	I		1pc
	Clapboard	J		1pc
	Leg	K		2pcs
	Leg	L		2pcs
	USB-PLUG	M		1pc
	Bolt	O		2pcs
	Phillips head screws	P	 7*25MM	4pcs
	Allen Key	Q		1pc

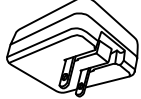
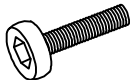
Sofa Assembly Instructions

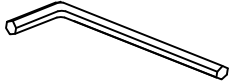
Step 1:

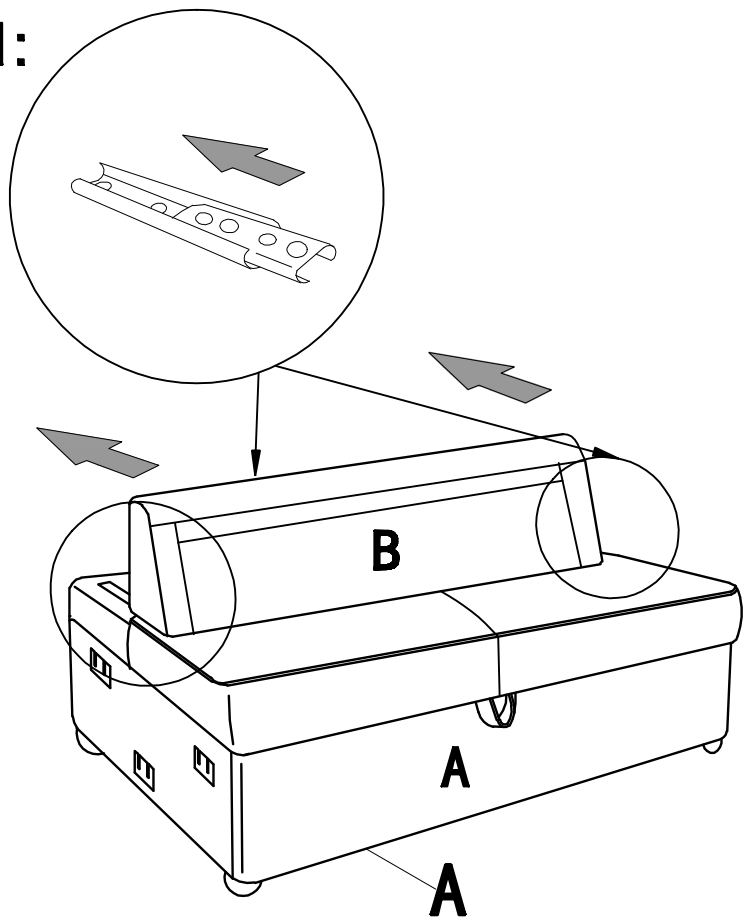

Step 2:

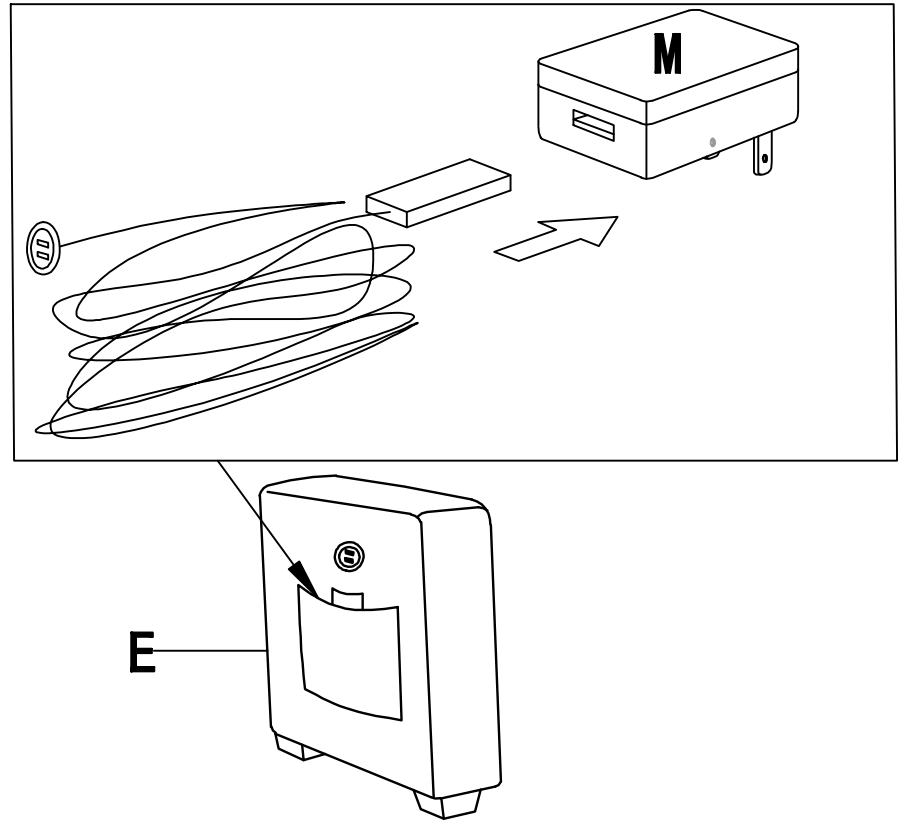

Step 3:

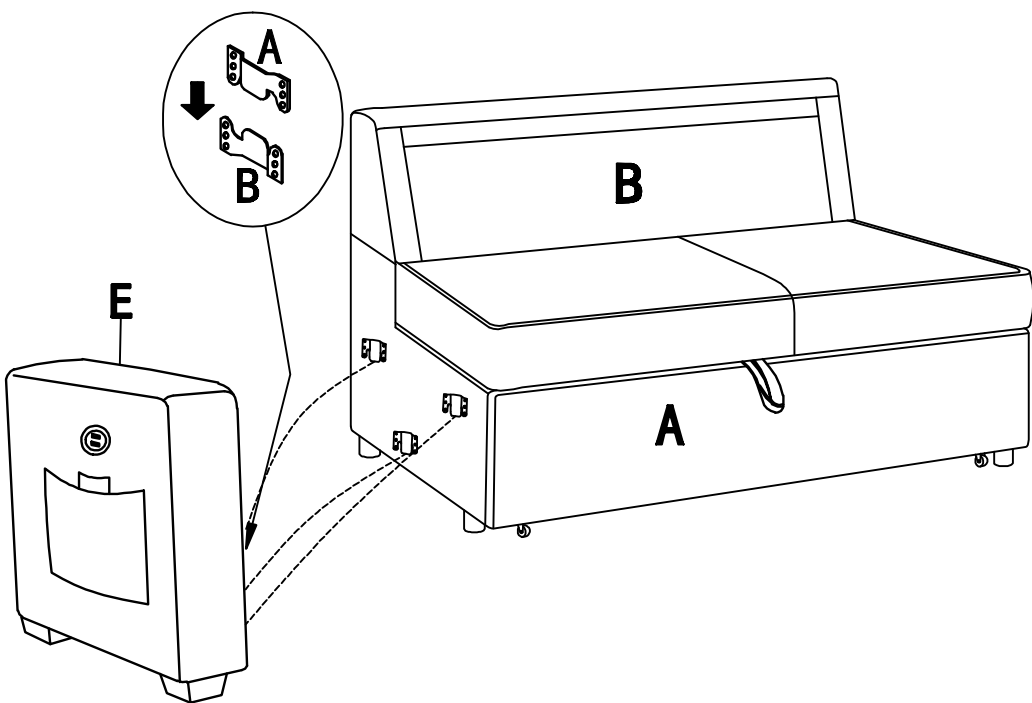

Step 4:

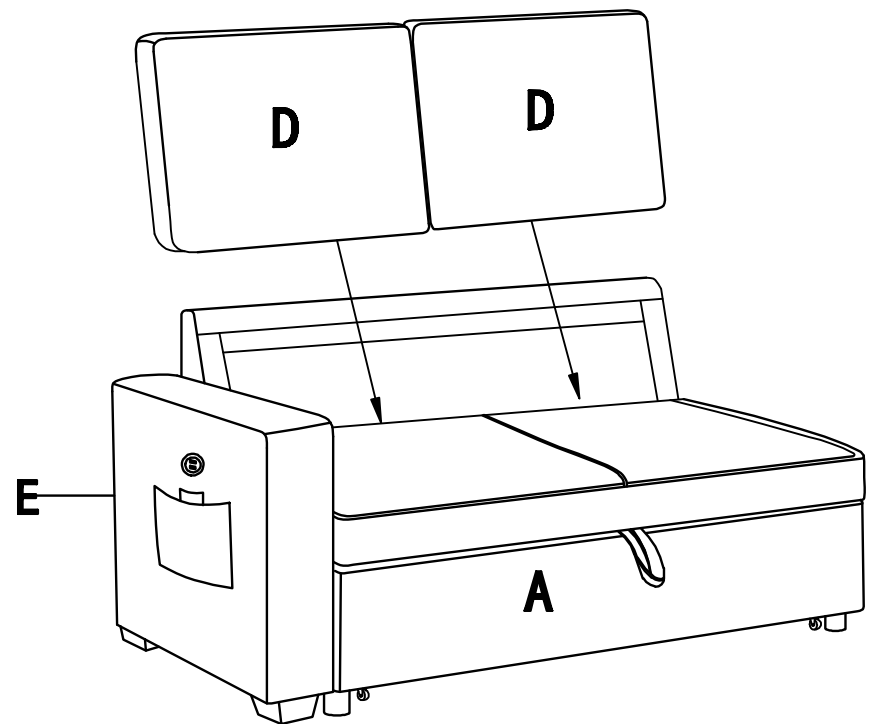

Step 5:

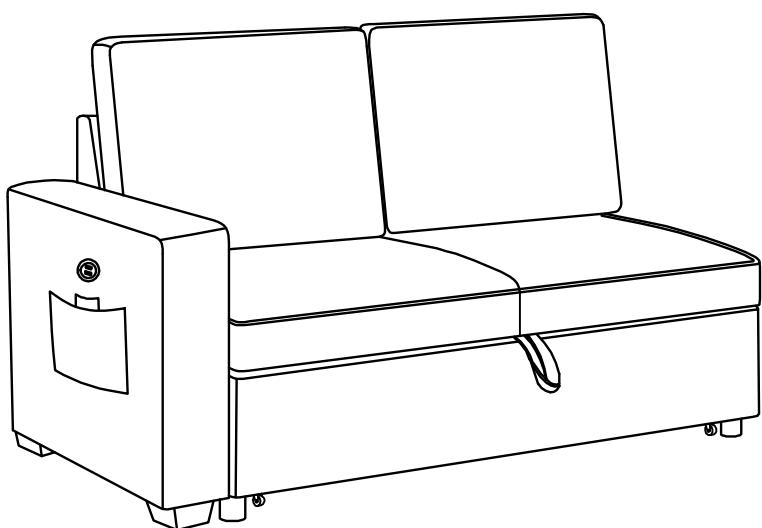

Chaise Assembly Instructions.

Step 6:

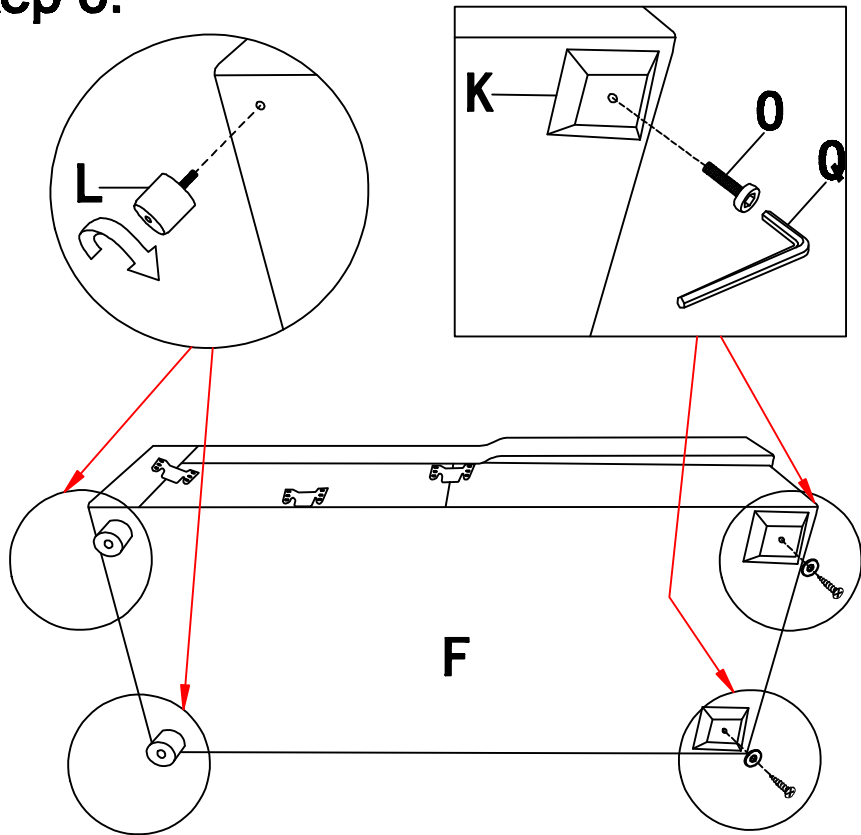

Step 7:

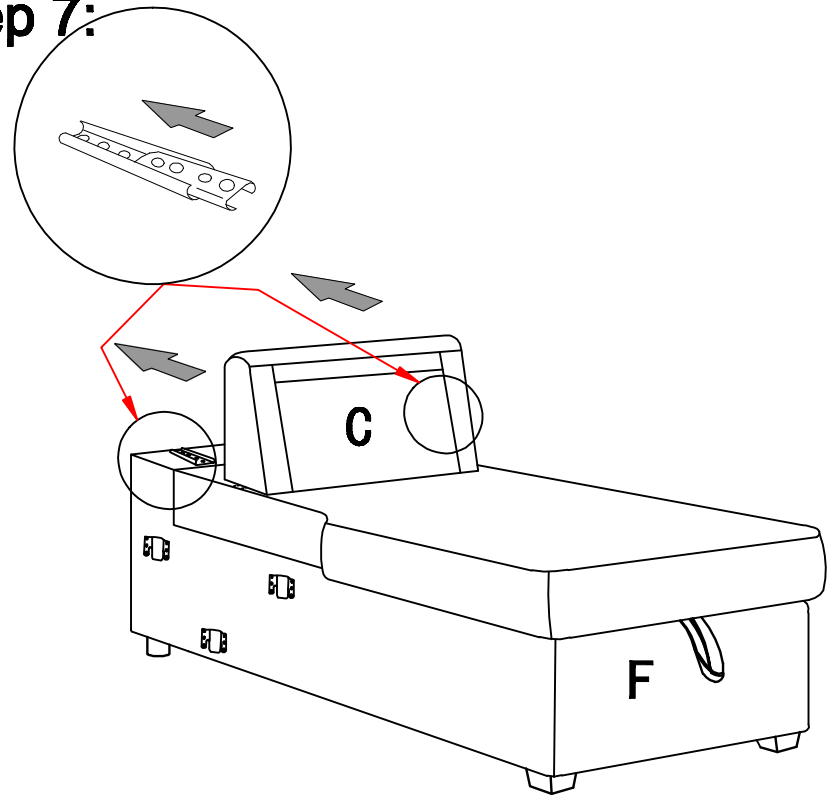

Step 8:

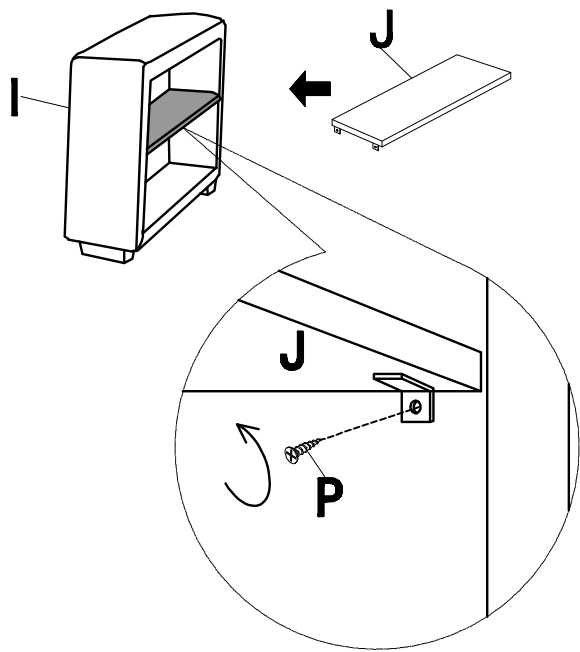

Step 9:

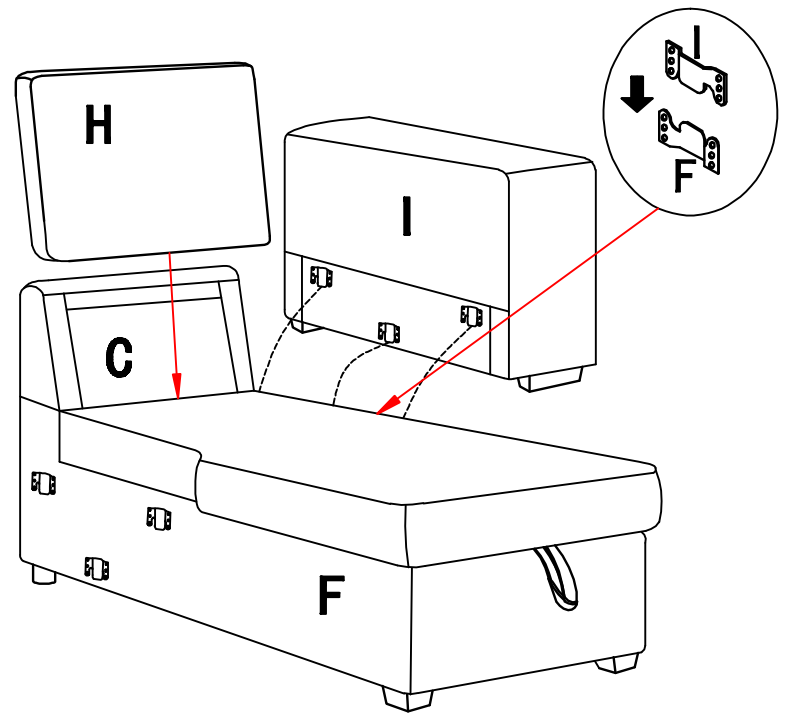

Step 10:

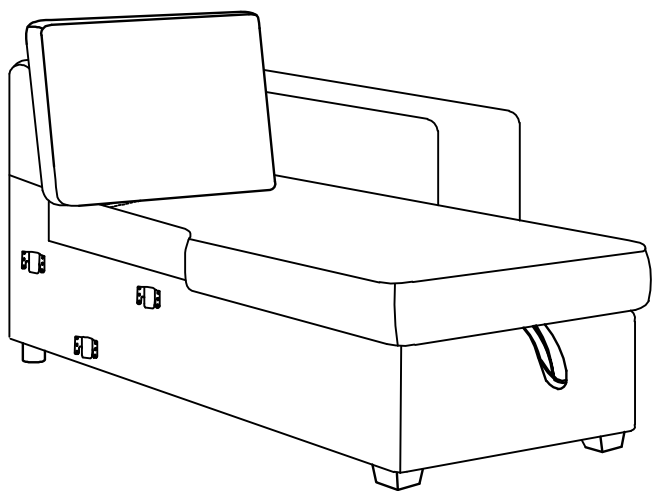

Right chaise

Step 11:

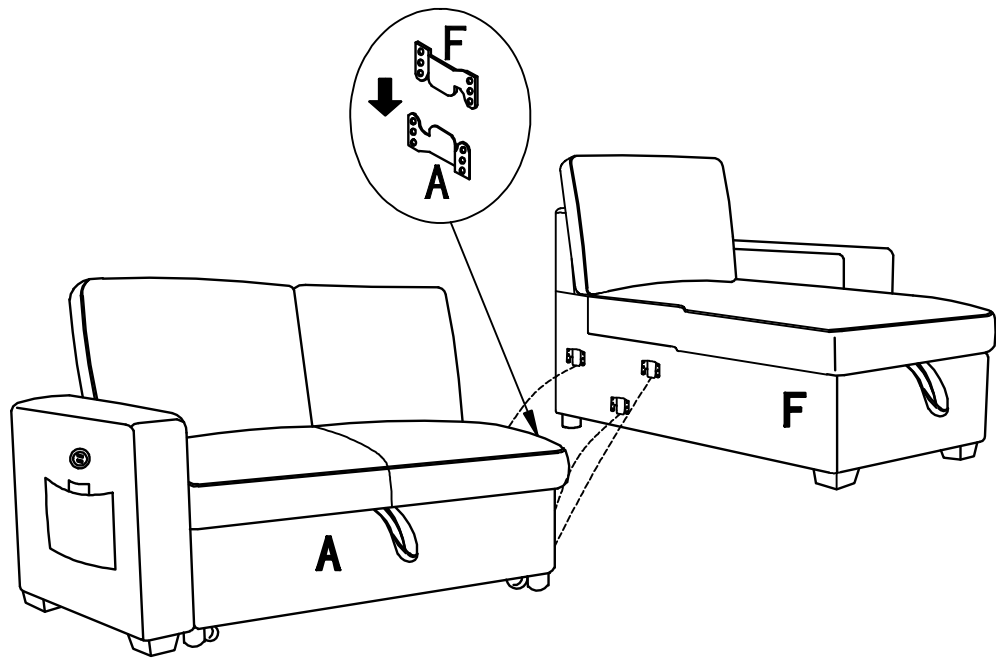

Step 12:

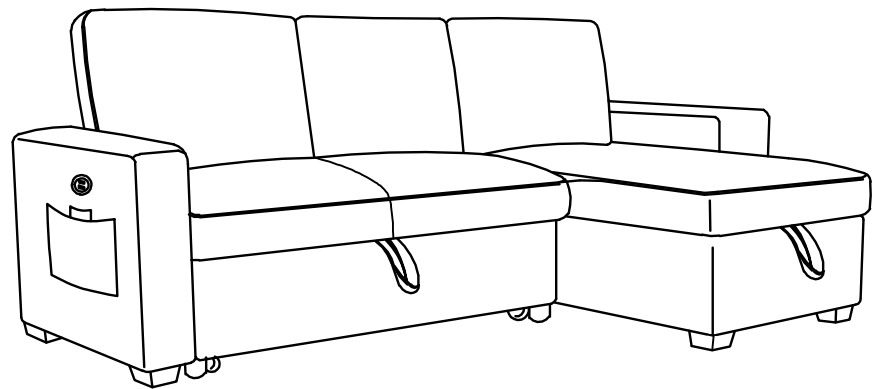

Left chaise

OR Step 11:

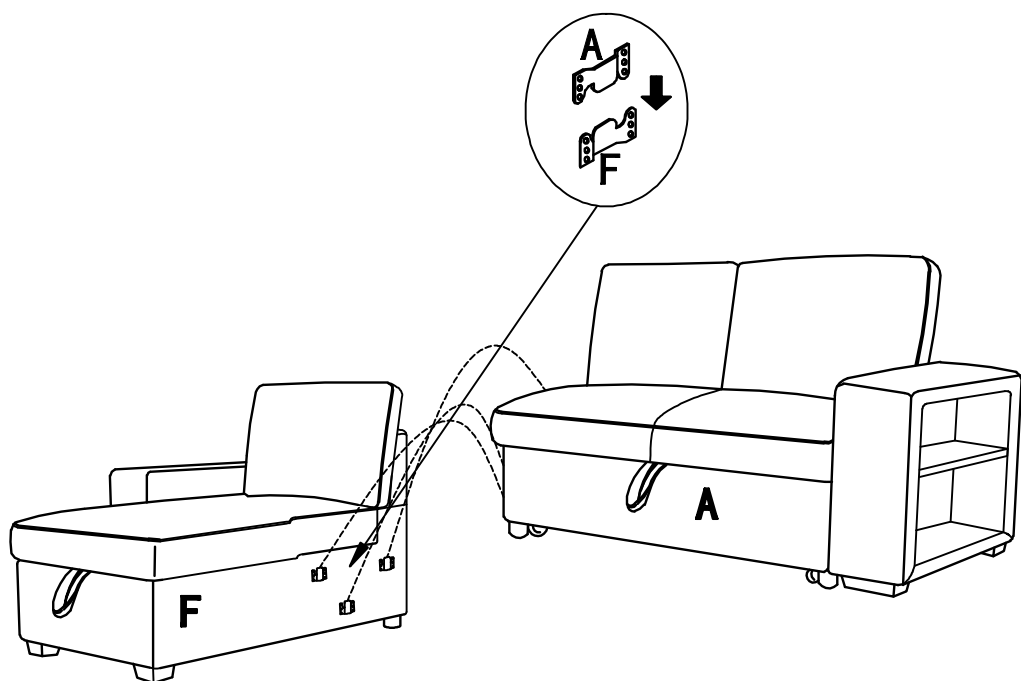

OR Step 12:

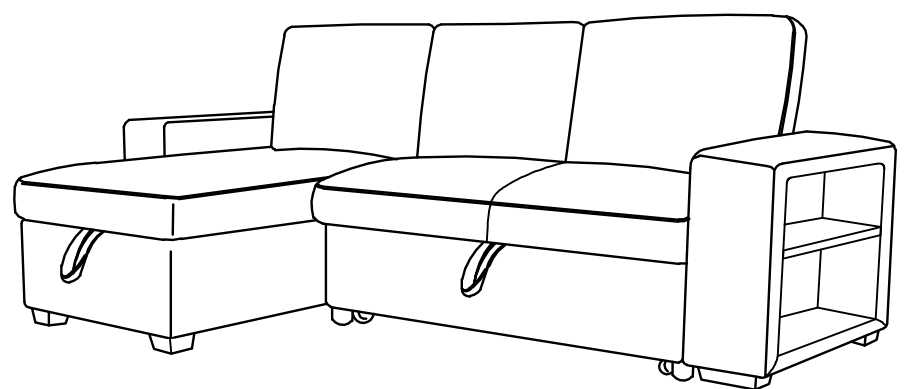

Function display of sofa

