

## Warranty

We offer a one-year warranty for the light fixtures

Our warranty ensures that any issues related to the performance or functionality of the light fixtures will be addressed and resolved promptly.

Our dedicated customer service team is available 24 hours a day to assist you. If you have any questions or concerns, we guarantee a response within 24 hours. During the warranty period, if you encounter any problems or need assistance, please don't hesitate to reach out to us via email. To ensure a swift and accurate resolution, kindly provide your order ID and detailed information regarding the issue.

**Important Note:** Please use this light fixture only for its intended purpose and avoid retrofitting or remodeling it. The warranty does not cover failures caused by third-party products or natural disasters.

# INSTALLATION INSTRUCTION

## Ø1520mm

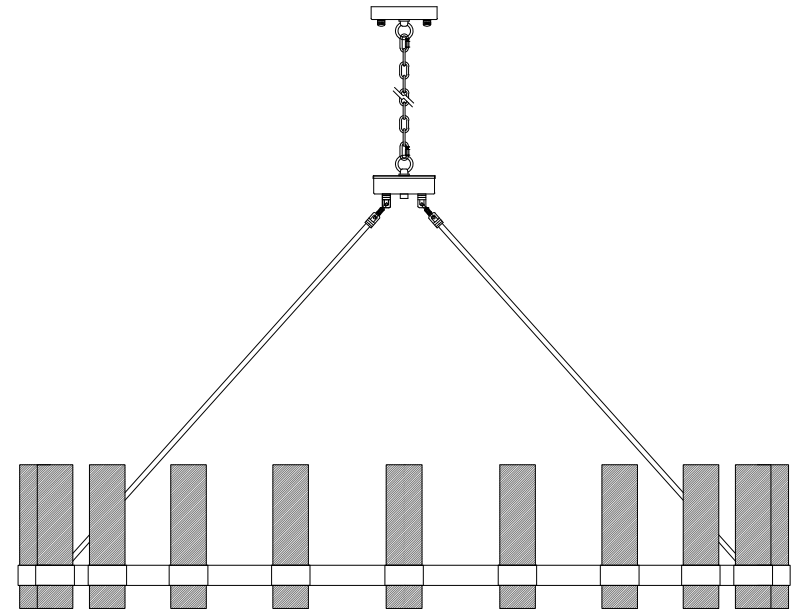

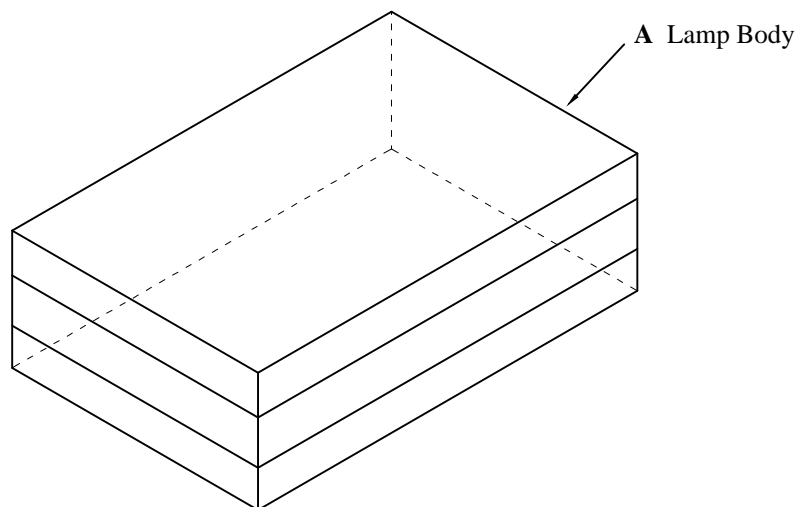

## SAFETY INFORMATION

It is important to thoroughly read and understand the entire manual, before assembling, operating, or installing the product,

## WARNING

- TURN OFF ELECTRICITY before installation, changing bulbs, or cleaning the light fixture.
- This fixture requires **20** pieces **E12** bulbs(not included in the product, the maximum wattage for each bulb is **25W**, please do not exceed the recommended wattage.
- A QUALIFIED ELECTRICIAN IS RECOMMENDED FOR INSTALLATION.
- Do not use corrosive substances such as gasoline or alcohol disinfectants to wipe the lamps, otherwise it will damage the lamps.

## PREPARATION

- Before installation, please make sure all the accessories are included (refer to the package content), if there is any part missing, please contact us at the order page, we will arrange the replacement in a timely manner
- **20** pieces of **E12** bulbs(**Max. 25W**) are required(not included in the product)
- For any questions or inquires, please feel free to contact us at the order page, our customer service team will reply ASAP.

# Installation instruction

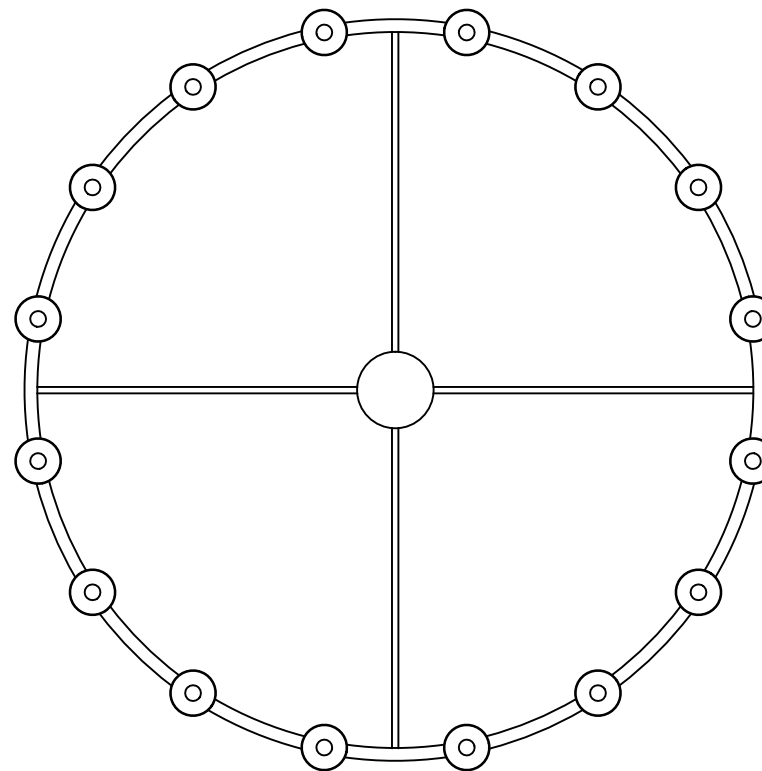

NOTES: Due to the handmade nature of the product, slight variations in dimensions may occur.

### Maintenance:

To ensure safe and efficient use of this product, please clean the lamp regularly (once a month). Before cleaning, turn off the power and wait for the lamp to cool to room temperature. Then use a soft cloth dipped in water and wrung dry to wipe it clean.

# Installation instruction

## Please note:

Please check the parts list, if the parts are missing during your actual installation, please contact us, we will help you in time!

NOTES: Due to the handmade nature of the product, slight variations in dimensions may occur.

### Maintenance:

To ensure safe and efficient use of this product, please clean the lamp regularly (once a month). Before cleaning, turn off the power and wait for the lamp to cool to room temperature. Then use a soft cloth dipped in water and wrung dry to wipe it clean.

# PACKAGE CONTENTS



4pcs



4pcs



4pcs

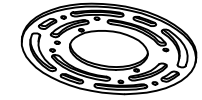

1pcs



canopy-1pcs

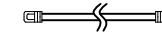

Circular tube-5pcs



Lamp Body-1pcs



glass tube-21pcs



sling chain-1pcs



glass tube-21pcs



Latch-10pcs

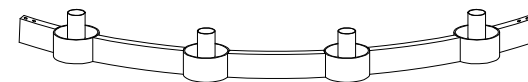

Lamp Body-5pcs

# Installation instruction

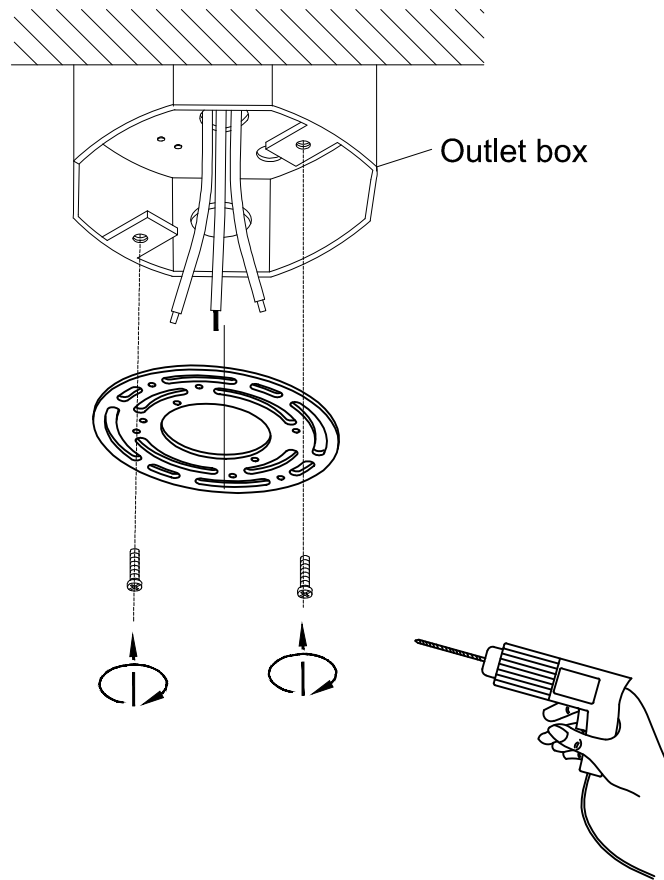

①

Steps:

1. Take out the lamp body and check the firmness of the lamp body;

Steps:

1. Remove the crossbar from the pre assembled mounting base;

2. Lock the crossbar on the junction box with the screw.

# Installation instruction

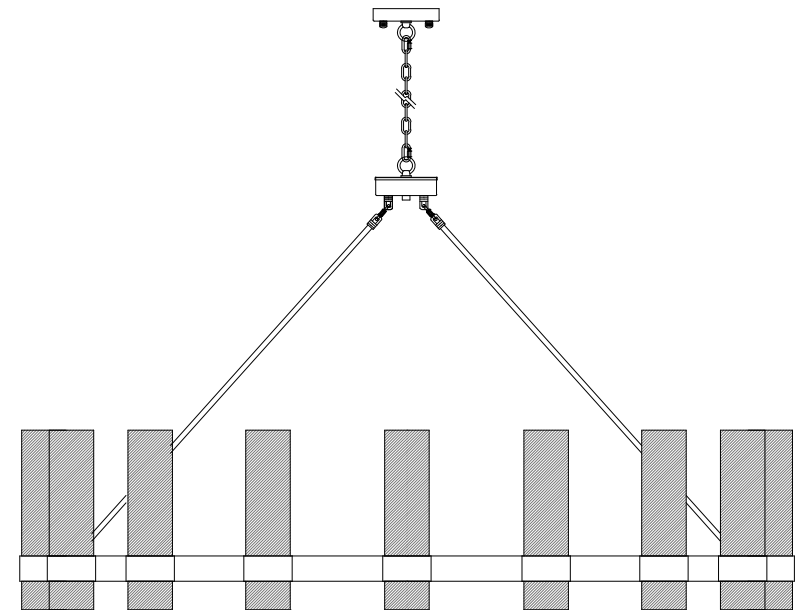

NOTES: Due to the handmade nature of the product, slight variations in dimensions may occur.

Cautions.

- 1. This lamp can only be used indoors;
- 2. TURN OFF THE POWER BEFORE THE INSTALLATION IS FINISHED.

# Installation instruction

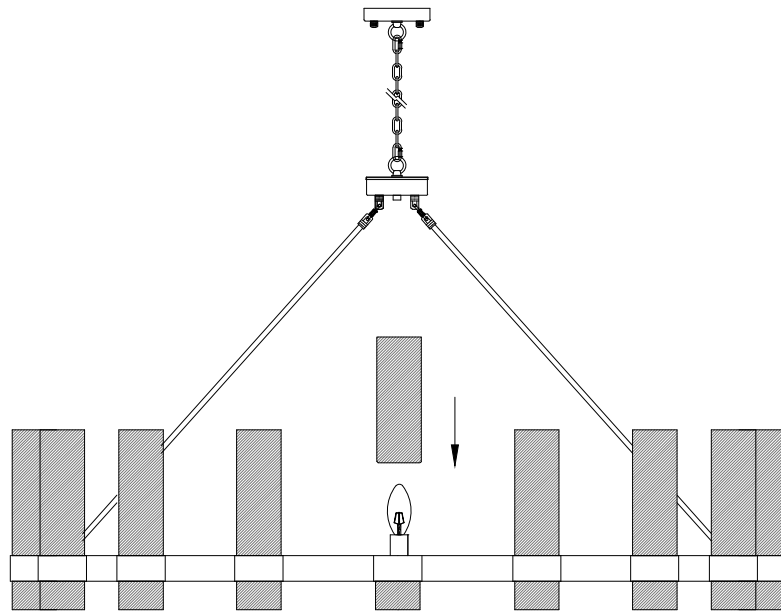

5

Steps:

1. Place the long glass tube into the lamp body, please symmetrically place it to maintain the balance of the lamp body.

# Installation instruction

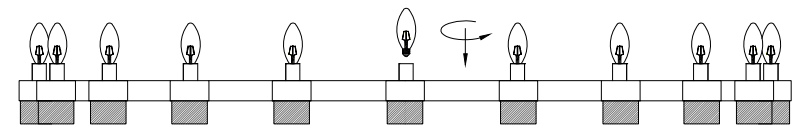
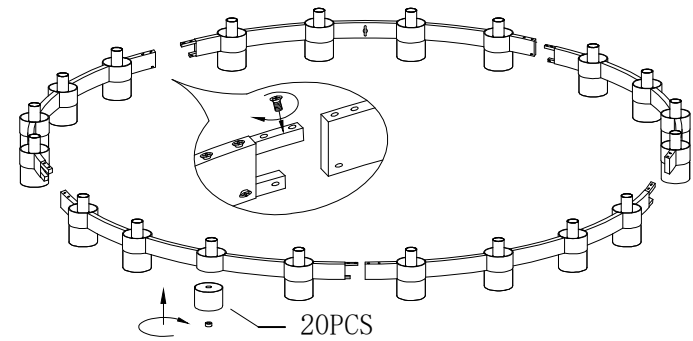

2

Steps:

1. Tighten the lamp body with screws according to the diagram, unscrew the nut at the bottom of the lamp body, and install the glass cover before tightening the nut.
2. Install the **20 E12** bulbs by screwing them into the light bulb sockets.

 **WARNING:** E12 The light bulb, MAX25W BULB\* 20PCS.

# Installation instruction

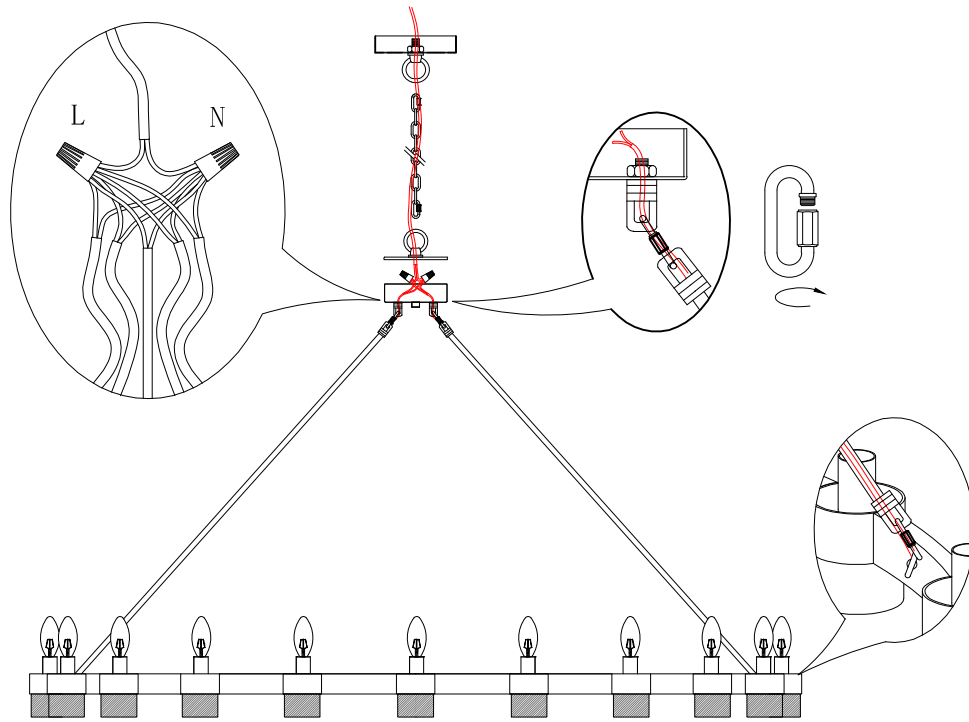

3

Steps:

1. Thread the power cord through the circular tube lamp body and tighten the screw. Connect the lamp body to the ceiling panel with a hanging chain and thread the power cord through it.

# Installation instruction

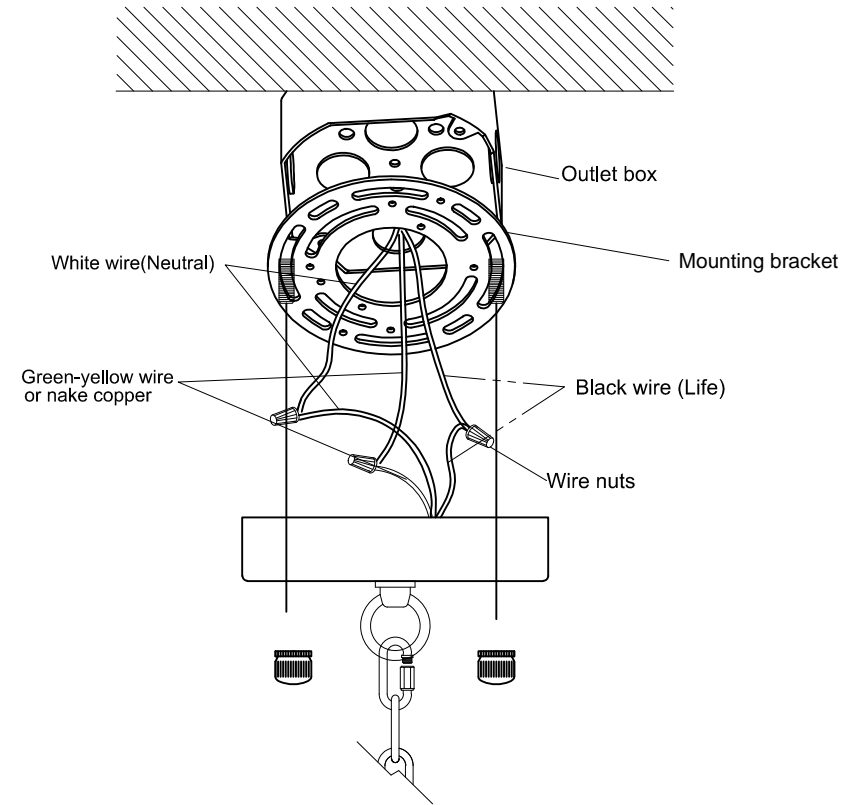

4

Steps:

1. Lift the installed lamp body to the bracket position and connect the wires, then lift it to align with the screw holes.
2. Use the matching screws to tighten it.