

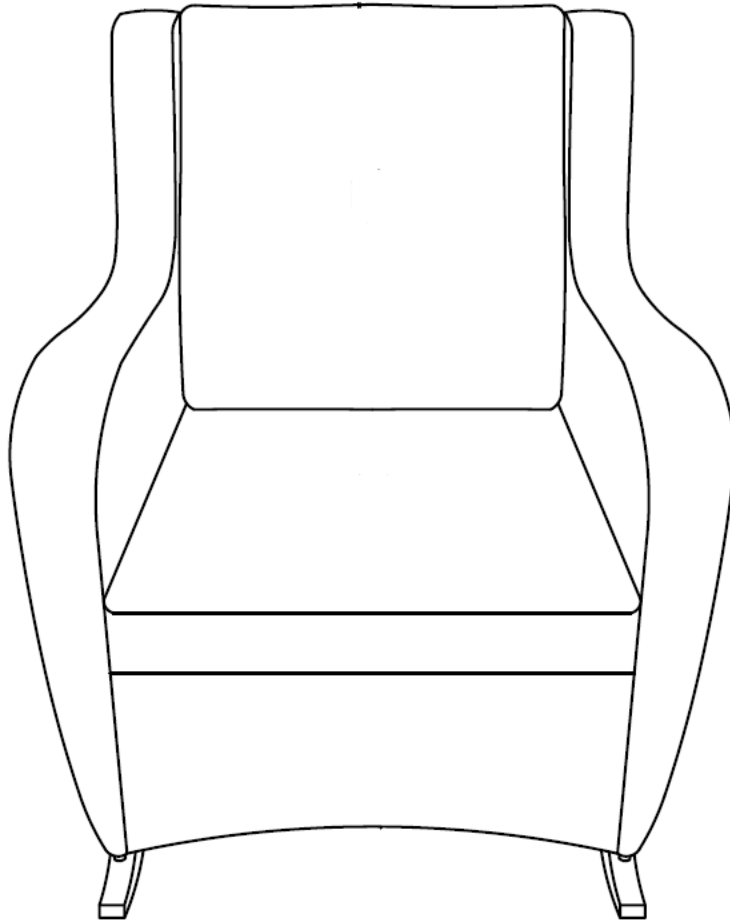









Assembly Instructions

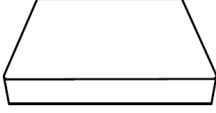
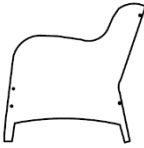

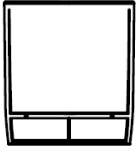
***Don't fully tighten all the bolts till the very end!**

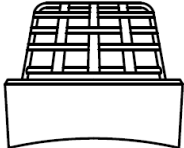
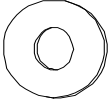

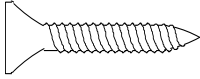
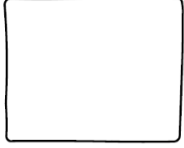
PRE-ASSEMBLY PREPARATION:

- Please read through the instructions before beginning assembly.
- Clear out the space for assembly and lay out all of the parts based on the Parts List, extra room will allow you to easily determine if all the pieces are present.
- Keep small parts and pieces away from children until fully assembled.

Part no.	Part	QTY	Image	Part no.	Part	QTY	Image
A1	Left arm	1		F	Seat cushion	1	
A2	Right arm	1		G	Bolt (M6*15mm)	4	
B	Back	1		H	Bolt (M6*35mm)	6	
C	Seat	1		I	Washer	10	
D	Runner	2		J	Self-tapping Screw (M5*35mm)	4	
E	Back cushion	1		K	Allen Wrench	1	

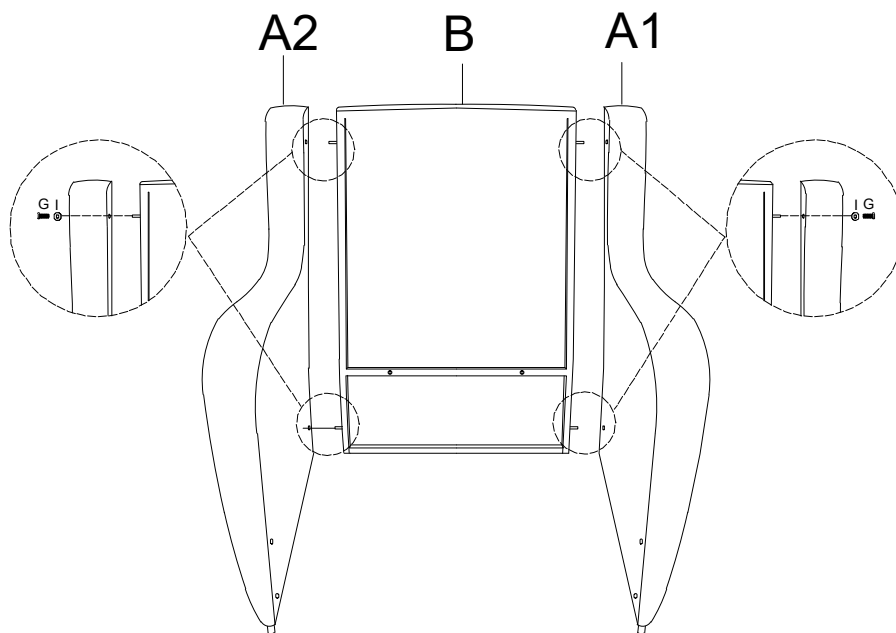

Step 1: Attach arms A1&A2 to back B with 4pcs bolts G and 4pcs washers I, using Allen wrench K. Note: Don't fully tighten the bolts.



G		M6*15	4
I		Ø16*Ø6.5*1	4

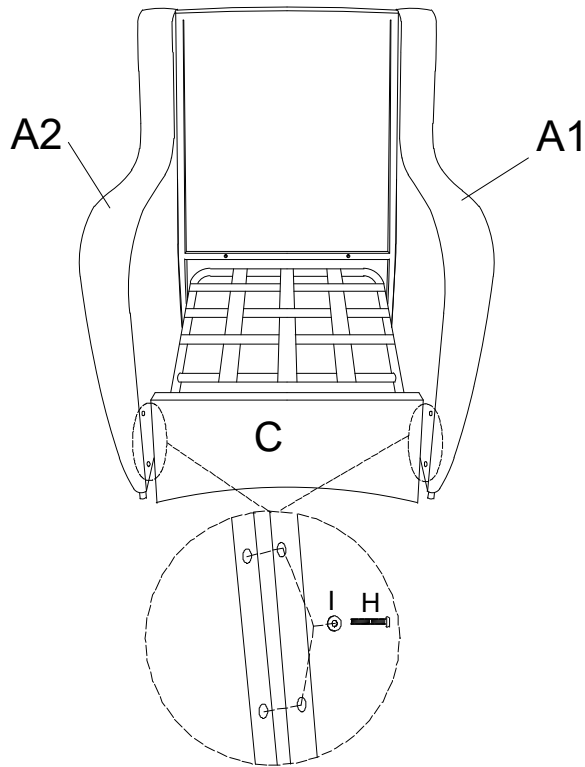

Step 2: Attach seat C to arms A1&A2 with 4pcs bolts H and 4pcs washers I, using Allen wrench K. Note: Don't fully tighten the bolts.

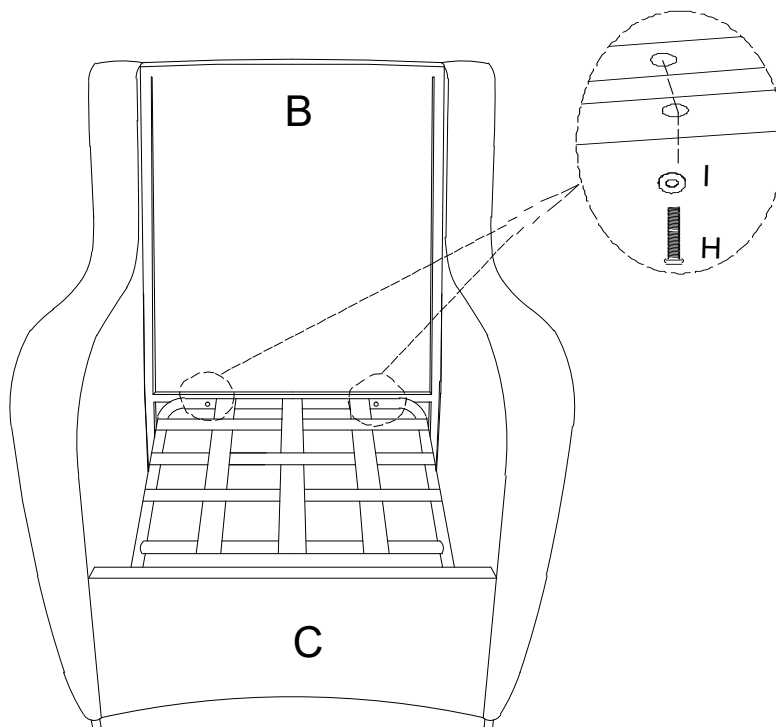

H		M6*35	4
I		Ø16*Ø6.5*1	4

Step 3: Attach seat C to back B with 2pcs bolts H and 2pcs washers I, using Allen wrench K. Note: Please fully tighten all the bolts.



H		M6*35	2
I		Ø16*Ø6.5*1	2

Step 4: Attach 2pcs runner D to arms A1 & A2 with 4pcs self-tapping screws J.

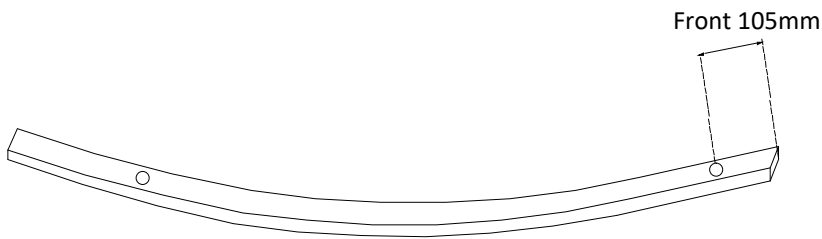
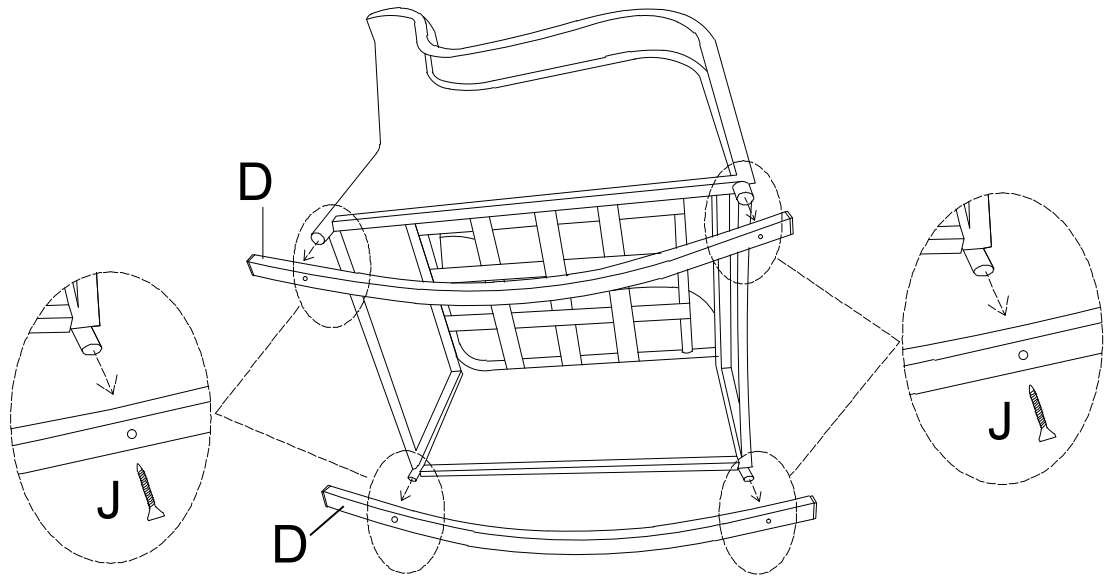

J		M5*35	4
---	---	-------	---

Step 5: Put seat cushion F and back cushion E onto the seat. Assembly is now complete and the product is ready for use.

