

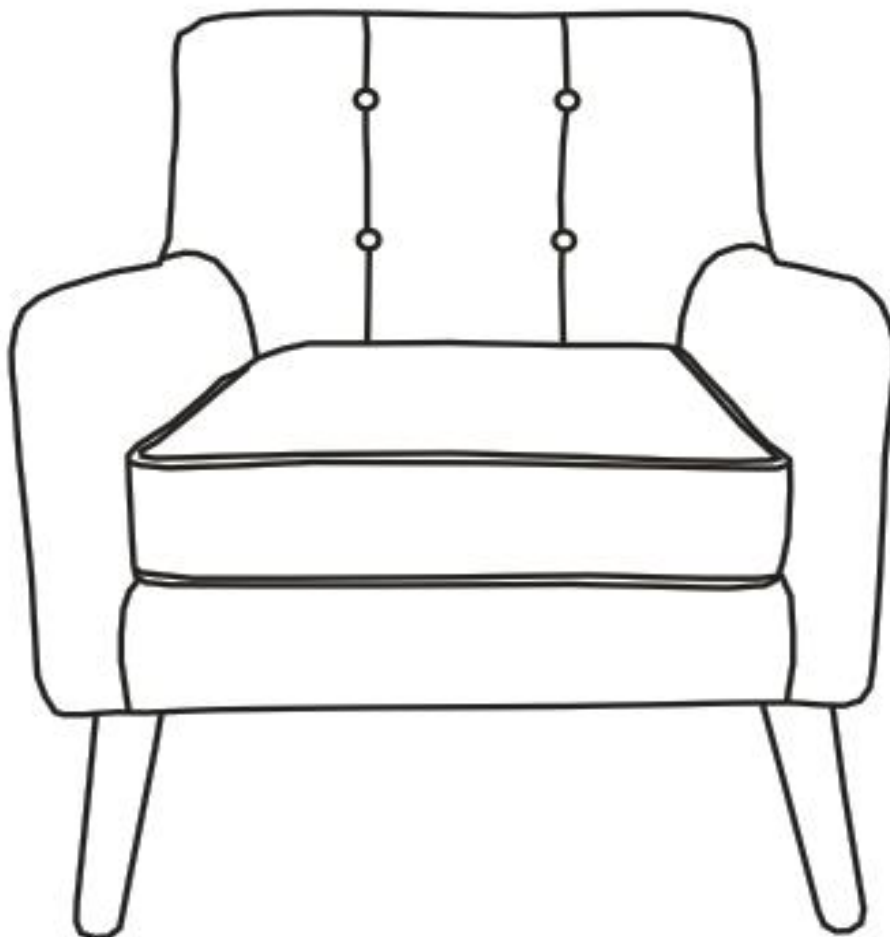

# Assembly Instructions

Caution: You must read this before you proceed.

## Club Chair



## Parts List

Label	Picture	Description	QTY
A		Chair Seat	1
B		Wooden Leg	4

## Hardware

Label	Picture	Description	QTY
①		Gasket	4

## Assembly Preparation

Before Beginning Assembly:

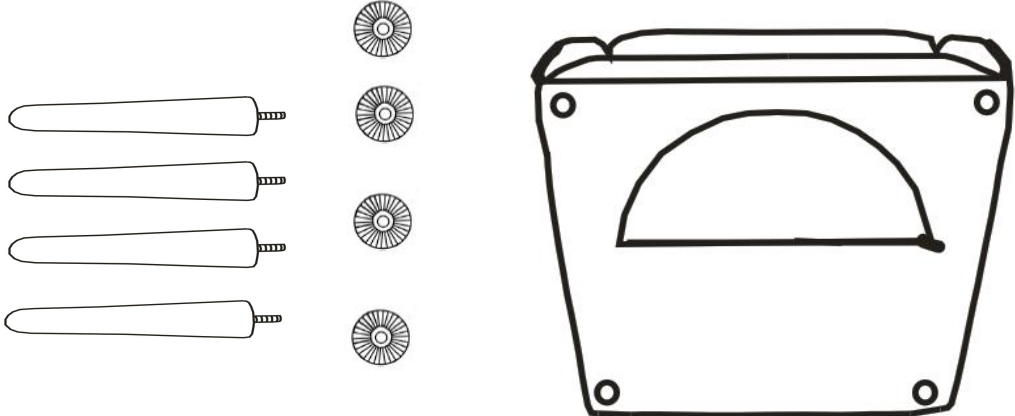

- Read instructions, cover to cover-



- Have 2 adults on hand for assembly-



- Do not assemble on flooring or carpet-



- Assemble on a clean non-marring surface (packing foam)-



- Save all packaging until finished-

# Assembly Steps

## Overview

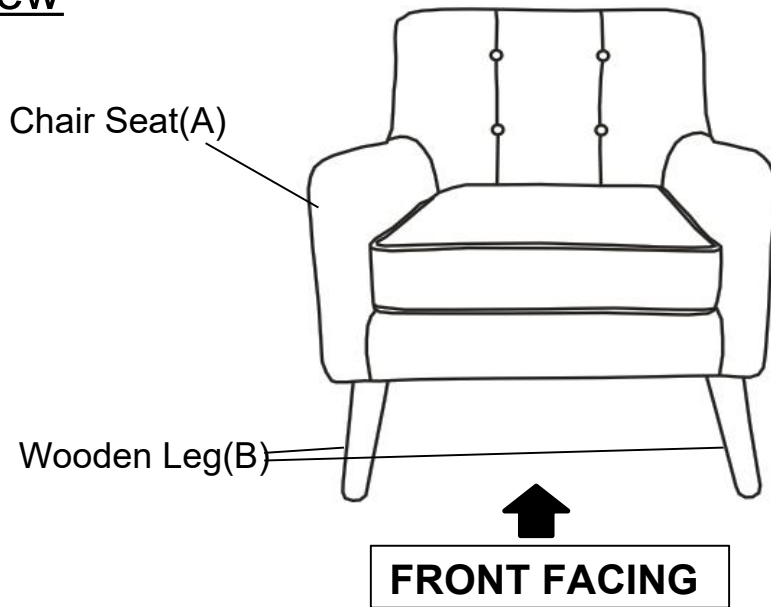

This Club Chair has multiple parts and may require up to 30 minutes to assemble. To give you an overview of the Club Chair parts, the above picture is to help you put the various parts into perspective. Please read through the instructions below to familiarise yourself with the parts and steps before assembly.

## Step 1

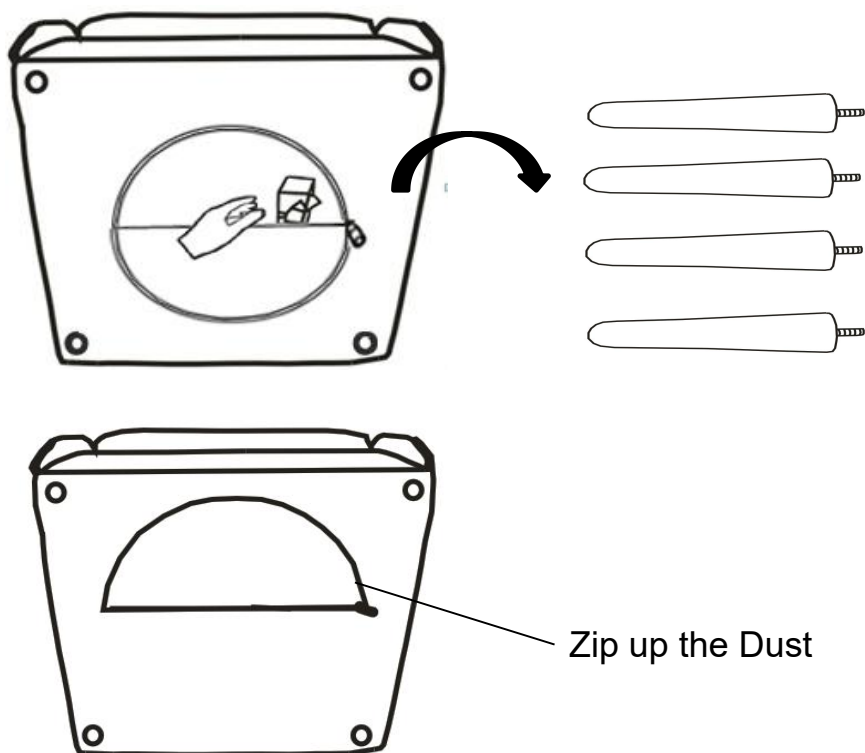

Place the Chair Seat(A) on a clean, non-marring surface with the bottom facing you, as shown in the picture above.

Carefully unzip the Dust Cover at the bottom, and remove the Legs. Zip up the Dust Cover.

## Step 2

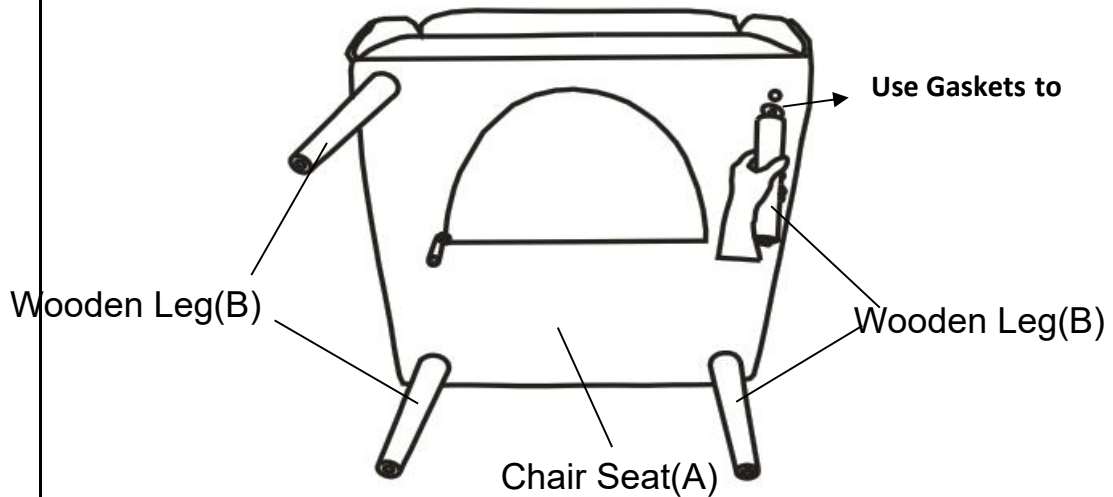

Install the Wooden Leg(B) into the Chair Seat(A) by putting a Gasket(①) on the threaded stem of the Leg.

Then insert the threaded stem of the Wooden Leg(B) into the Top Corner mounting positions of the bottom of the Chair Seat(A).

Affix the Leg by turning it clockwise by hand until secure.

Repeat this process with the remaining three Wooden Legs.

**Note: The use of the Gaskets are OPTIONAL and are especially useful to help alleviate slight wobbles. Some Legs may need more than one whilst some Legs may not need any.**

## Step 3

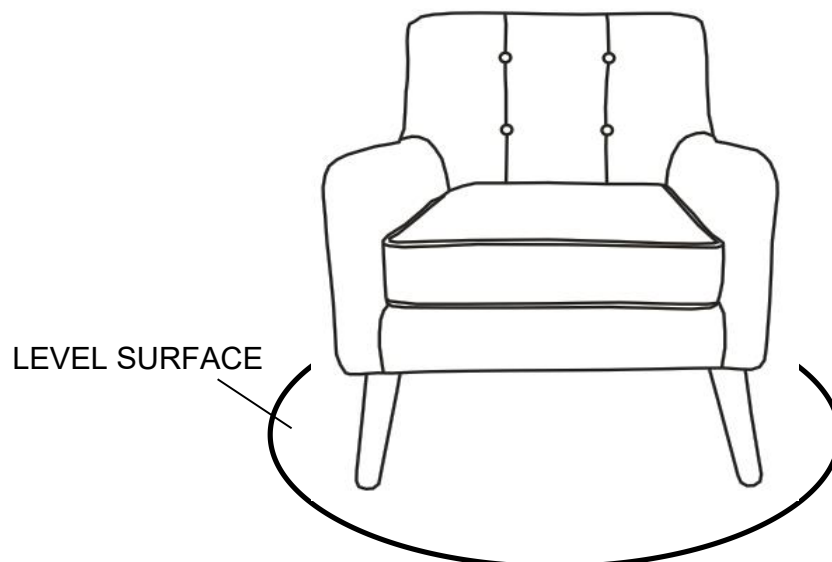

Position the Chair right side up and test for stability.

**Add or remove Gaskets(①) where needed to achieve stability.**

#### Step 4



**Front Profile**

Front legs should splay toward the left and right sides



**Side Profile**

Back legs should splay towards the back.

**Make sure all the parts are connected and securely locked into position and Legs are in the correct positions.**

After completion of the assembly, the Left Front Leg shall be splayed towards to the Left and the Right Front Leg to the right.











The Back Legs should splay outwards and towards the back.

If the Legs do not point in an outward direction, Gaskets can be added or removed to achieve the necessary angle.

Your Club Chair is ready for use.

**This Club Chair can only be used on a flat, level surface.**

## Care & Maintenance

-  ● Do not put hot items directly on furniture surface
  -  ● Do not clean furniture with harsh cleansers or polish.
  -  ● Do not place furniture under direct sunlight.
  -  ● Do not place furniture near heating or cooling vents.
  -  ● Do not write on furniture without a padded barrier to protect the surface.
  -  ● Do not place furniture outside . For indoor use only .
  -  ● Not for commercial use. For residential use only .
  -  ● Stains may be removed with mild soap solution and damp cloth.
  -  ● Children should not climb or jump on the furniture.
- 
-  ● Dust and pick-up spills using a clean, non-colored, lint-free cloth .

## Questions & Answers about Proposition 65

### • What is Proposition 65?

Proposition 65 requires businesses to provide warnings to Californians about significant exposures to chemicals that cause cancer, birth defects or other reproductive harm. These chemicals can be in the products that Californians purchase, in their homes or workplaces, or that are released into the environment. By requiring that this information be provided, Proposition 65 enables Californians to make informed decisions about their exposures to these chemicals.

Proposition 65 also prohibits California businesses from knowingly discharging significant amounts of listed chemicals into sources of drinking water.

Proposition 65 requires California to publish a list of chemicals known to cause cancer, birth defects or other reproductive harm. This list, which must be updated at least once a year, has grown to include approximately 900 chemicals since it was first published in 1987.

### • What types of chemicals are on the Proposition 65 list?

The list contains a wide range of naturally occurring and synthetic chemicals that include additives or ingredients in pesticides, common household products, food, drugs, dyes, or solvents. Listed chemicals may also be used in manufacturing and construction, or they may be byproducts of chemical processes, such as motor vehicle exhaust.

### • What does a warning mean?

If a warning is placed on a product label or posted or distributed at a workplace, a business, or in rental housing, the business issuing the warning is aware or believes that it is exposing individuals to one or more listed chemicals.

By law, a warning must be given for listed chemicals unless the exposure is low enough to pose no significant risk of cancer or is significantly below levels observed to cause birth defects or other reproductive harm.

### • Where can I get more information on Proposition 65?

If you have specific questions on the administration or implementation of Proposition 65, you can contact OEHHA's Proposition 65 program at [P65.Questions@oehha.ca.gov](mailto:P65.Questions@oehha.ca.gov), or by phone at (916) 445-6900.