

60-INCH CEILING FAN WITH LIGHT

Model NO: SY100-60

USER MANUAL



Thank you for purchasing our product. Before using the product, please read this manual carefully and keep it for future reference



INDEX

After-sales service.....	1
Warning notes + Mounting tools.....	2
Package Contents + Accessories.....	3
STEP 1. Choice of Height.....	4
STEP 2. Fan blade installation	6
STEP 3: Lamp board installation	8
STEP 4: Connect the power cord to the receiver	10
STEP 5-1:Install wooden roof brackets	11
STEP 5-2:Installation of cement roof bracket.....	12
STEP 6: Connect the power cord	14
STEP 7: Fixing the canopy	15
Inverter fan light remote control	17
Introduction to APP control.....	17
Energy saving usage.....	18
Trouble shooting	19

Customer Service:

Customer Satisfaction is Our Life long Pursuit

If you encounter any issues during use, you can email us at lspmke_service@163.com at any time. We will do our most to solve your problem and respond within 12 hours. Providing us with a video or pictures, if available, would be appreciated.

VIP Quality Assurance

You can send your order number to our email to register for our VIP warranty service, which offers free replacement for quality issues within 3 years.

We Welcome Your Ideas and Feedback

If you have any thoughts or suggestions, please feel free to let us know, Your feedback is invaluable in helping us improve our products and services.

✉ After-sale team:lspmke_service@163.com

WARNING!!!

To avoid fire, shock and serious personal injury, follow these instructions.

1. Read your user manual and safety information before installing your new fan. Review the accompanying assembly diagrams.
2. Before servicing or cleaning the unit, switch off the power at the service panel and lock the service panel to prevent accidental power activation. If the service disconnecting means cannot be locked, securely attach a warning device, such as a tag, to the service panel.
3. Exercise caution around the fan and its blades when clearing, repairing, or working near the fan. Always turn off the power to the ceiling fan before performing any maintenance.
4. Do not insert any objects into the fan blades while the fan is in operation.
5. This appliance is not intended for use by young children or individuals with disabilities without supervision, Young children should be supervised to ensure they do not play with the appliance.
6. Before installing your ceiling fan, refer to the section on the proper wiring method for your fan. If you feel that you lack sufficient knowledge or experience in wiring, it is recommended to have a licensed electrician install your fan.

30-Days Full Refund Guaranter

This manual is designed to make it as easy as possible for you to assemble, install, operate and maintain your ceiling fan.

NOTE: Place the parts from the loose parts bags in a small container to keep them from being lost. If any parts are missing contact us.



Ladder



Phillips screwdriver

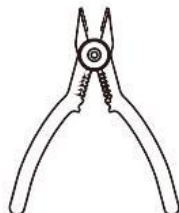

Wire Stripper s

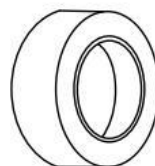

Electrical tape



Goggles

Installation Preparation

- To avoid personal injury and harm, make sure the fan is hung with the blades 2.3 m or more above the floor and 76 cm from the nearest wall or obstruction.
- Ensure that the mounting brackets are adequately attached to the building structure and can support the full weight of the fan.

Fan lights can be mounted at a tilt of 15%

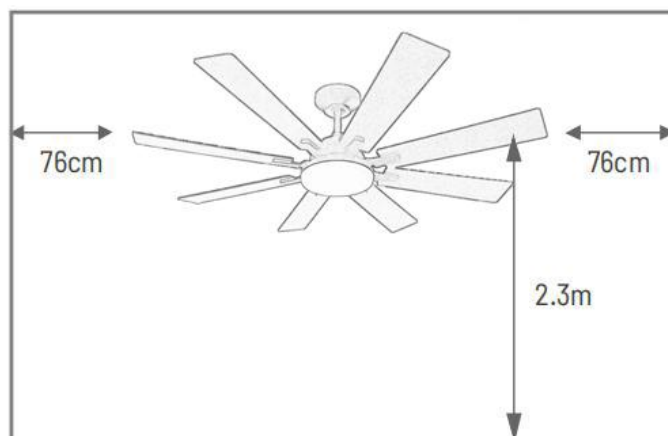

Accessories



ATTENTION! Before starting the assembly, remember to disconnect the light from the electrical box to avoid suffering an electric shock.

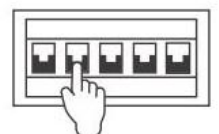

STEP 1. Choice of Height

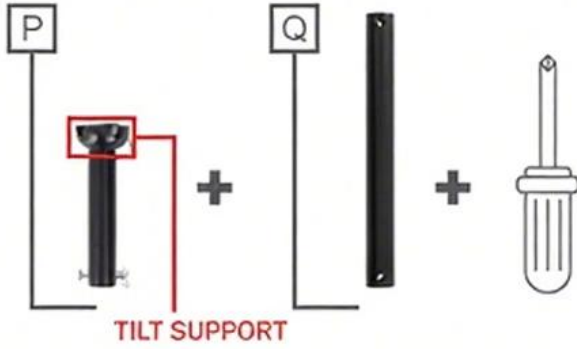

Before you start, choose the desired height.
(10cm +/-)

You will have to choose between the height of pieces P or Q.
·If you choose the height of piece Q, you need to follow the instructions below. ·If you choose the height of piece P, go directly to step 2 (page 6).

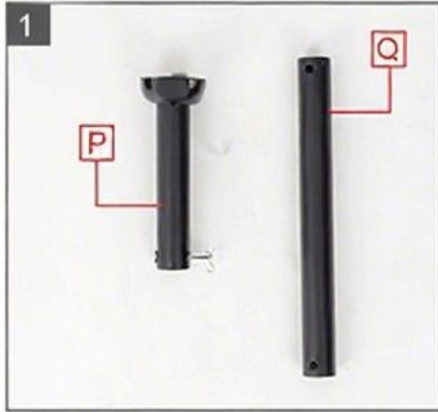

With the help of a screwdriver, remove the two screws from the tilt bracket of the bar P.

Slide the tilt bracket down.



Remove the pin from the tilt bracket.

Remove the tilt support from the bar P.

Remove the locking piece from the pin of bar P.

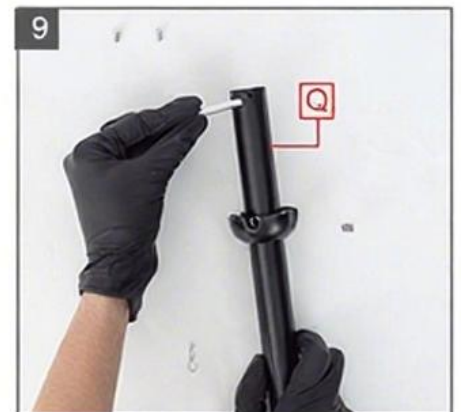

Carefully pull the pin out of the bar P.

Attach the tilt support to the bar Q.

Place the tilt support pin into the bar Q.

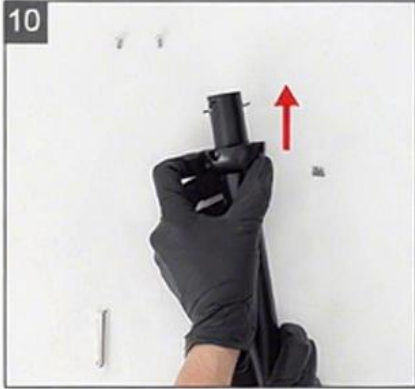

10 Fit the tilt bracket onto the pin.



11 Tighten the two screws on the tilt bracket with the screwdriver.



12 Put the pin back in the piece Q.



13 Secure the pin with the locking piece so that it does not come out.



14 The piece Q is ready to use.

STEP 2: Fan blade installation

Installation Instructions Recommendation: Detailed installation videos are provided on the Purchase Link homepage. It is recommended that you watch them before starting the installation process.

PARTS AND TOOLS

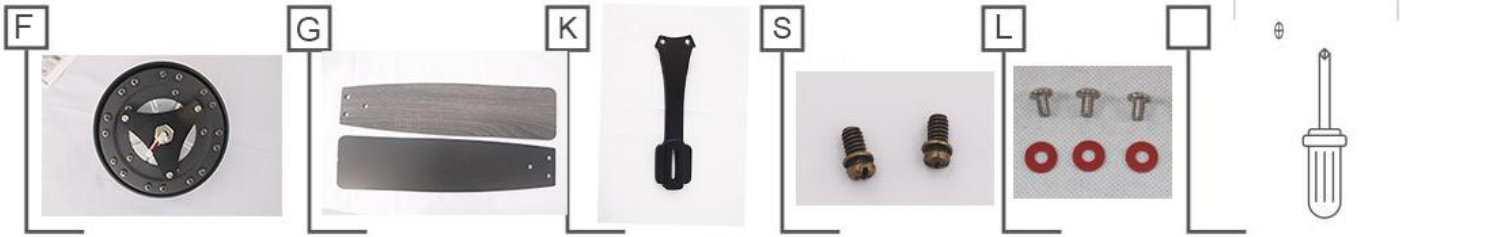

Ready to install accessories



Align the black fastener (K) with the screw hole of the fan blade and tightly fit it



Turn the fan blades over, tighten the blades with screw L and secure them



Repeat step 2.3 to install the eight sets of fan blades in sequence



Take out the motor F

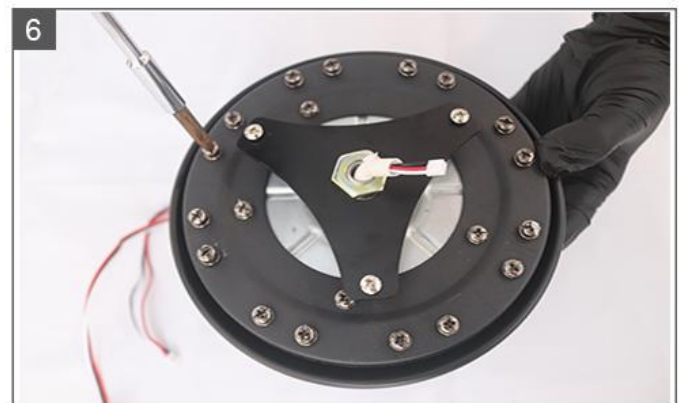

Remove the sixteen large screws from the motor in turn

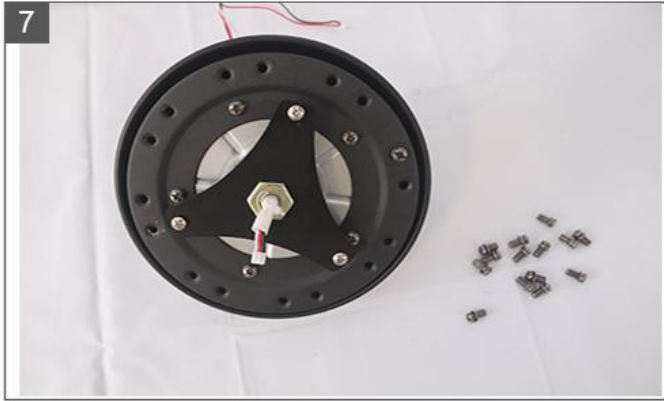

Motor screw removal complete

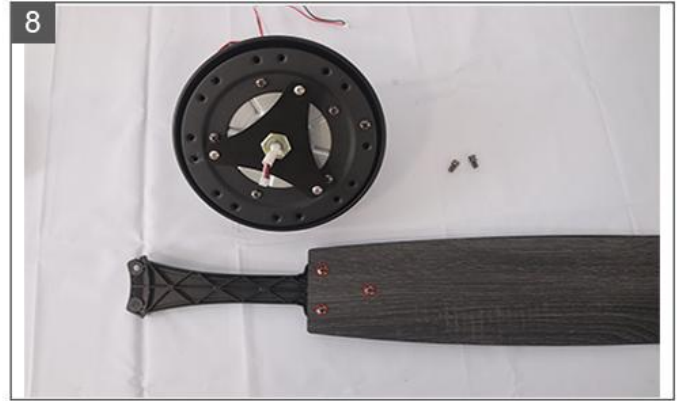

Prepare the screws between the fan blades and the motor



Securely tighten the fan blades (the side with the fork should face up). If the blade fork is installed in the wrong direction, there will be abnormal noise. And the motor, using the screws removed in step 6



Repeat the previous step to complete the installation of all eight sets of fan blades



The connection between the fan blades and the motor is completed

-Small Tips: The blades of the ceiling fan with light are two-colored (featuring a wood grain color on one side and a solid color on the other). The steps described above are for the installation when the solid color surface is facing downward during the operation of the ceiling fan with light. If you prefer to have the wood grain side facing downward, you can simply flip the fan blades over.

STEP 3: Lamp board installation

PARTS AND TOOLS



EQUIPMENT NOT INCLUDE

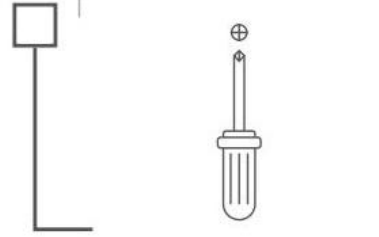

Remove the light board accessories, rotate slightly to the right to remove the LED lampshade



As shown in the picture, unscrew the screws in the red circle on the support of the motor lamp board, and loosen the remaining two screws



Insert the LED light tray into the power cord and turn it slowly so that the two screws on the light board pass through the screw holes on the light source board

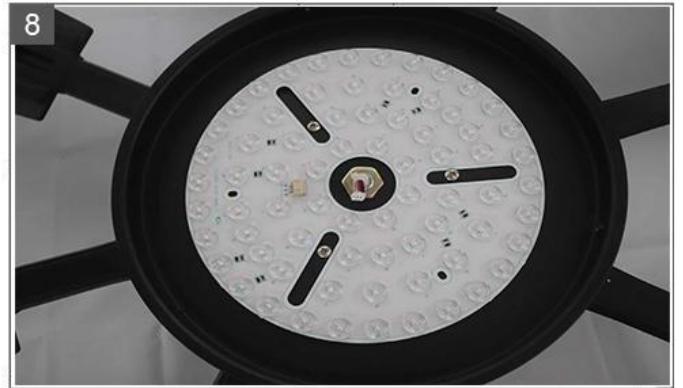

Turn the LED light panel to the right, jam two screws and expose the third screw hole, screw in the screw removed in step 3, and tighten the other two screws



the light source line should be aligned with the interface of the light panel, and then it needs to be pushed hard to connect. (Note: the raised side should face outward and the concave side should face inward)

As show, the lamp panel is installed well

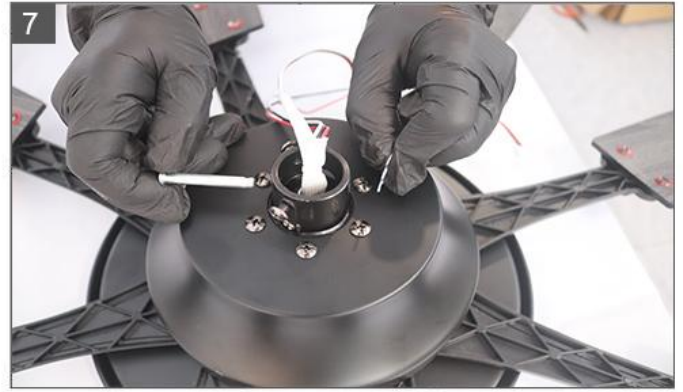

As shown in the picture, remove the top pin of the motor



Loosen the two large screws at the fixed point of the motor suspension rod



As shown in the figure, thread the power cord on the motor through the bar P, and then insert the bar P into the fixed position at the top of the motor



After the wire passes through the pole, it will be as shown in the picture. (P.S. It's a bit difficult for the wire to go through the entire pole, but I believe you can make it!)



As shown in the figure, slightly rotate the bar P to align the pin installation hole with the motor fixing hole

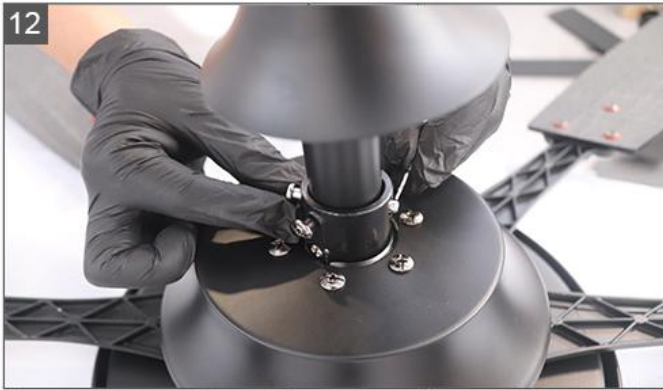

12 Insert the pin removed in Step 6 and secure it with a β -shaped needle



13 Tighten the two screws loosened in Step 8

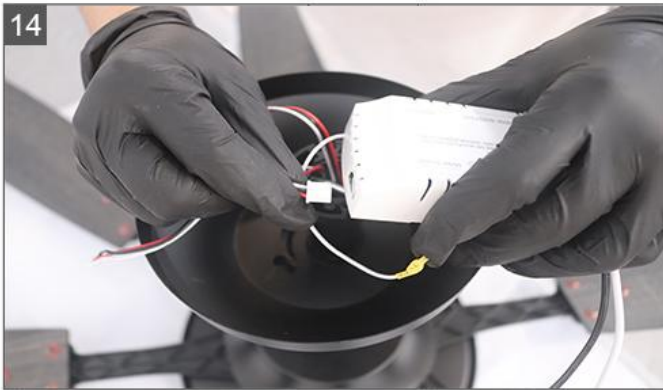

14 Slide down the decorative cover P to cover the top screw of the motor. And then take out the receiver,



15 As shown in the figure, connect the two light source line interfaces and the motor line interface correspondingly

STEP 5-1: Install wooden roof brackets

PARTS AND TOOLS

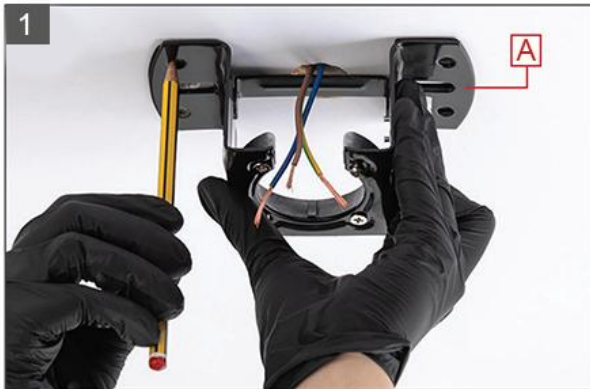
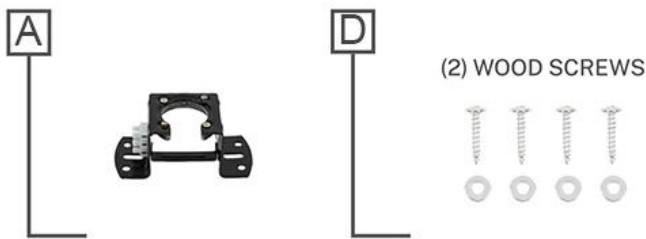

Mark with a pencil the 4 holes of the piece A in the ceiling.

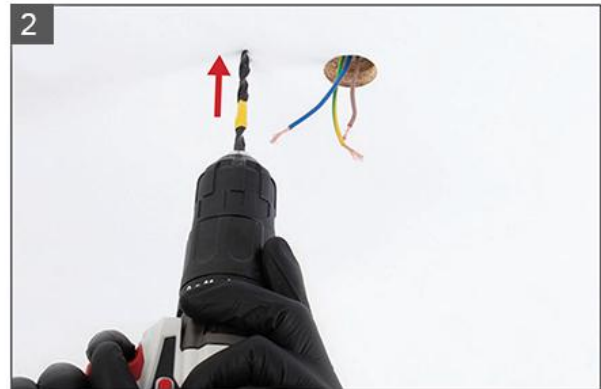

If necessary, depending on the type of ceiling, you will need to use a drill to make the hole in the wood.

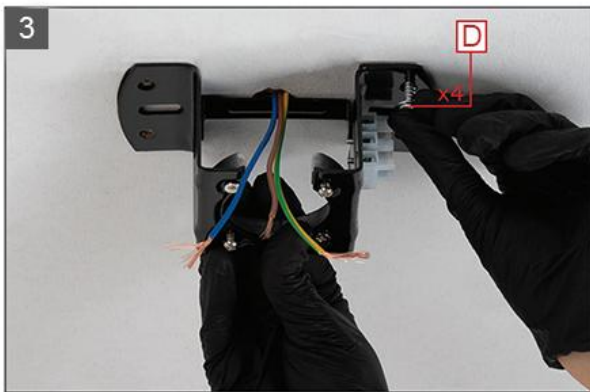

Place the washer and then the screw D .

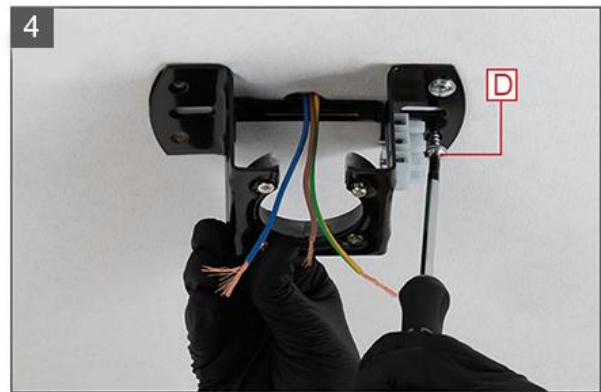

With the help of the screwdriver, tighten the screws D .

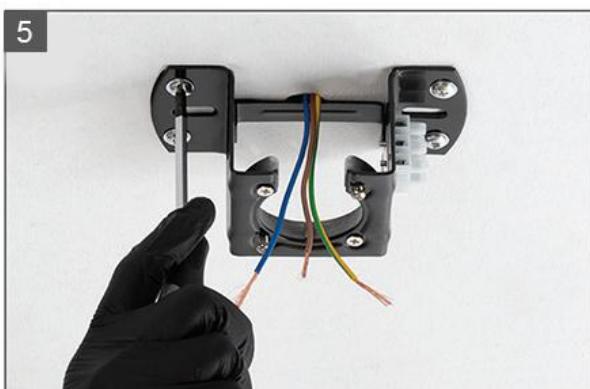

Repeat this step for the remaining holes.

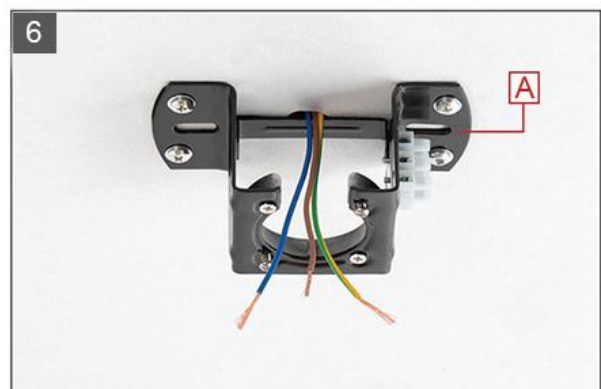

Make sure piece A is perfectly fixed to the ceiling and that no cables are trapped.

STEP 5-2: Installation of cement roof bracket

PARTS AND TOOLS

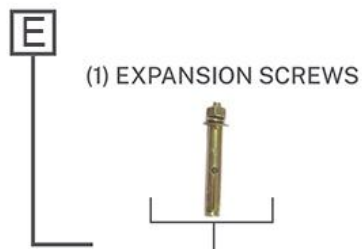
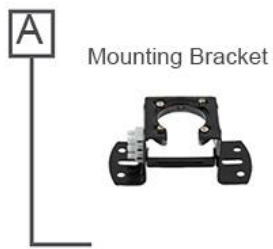

MATERIAL NOT INCLUDED

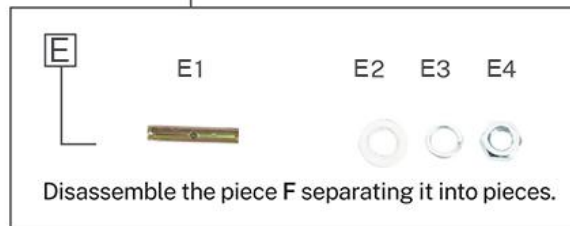
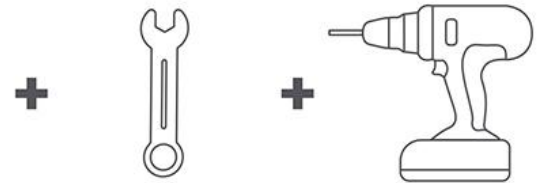

Mark with a pencil the 2 central holes of the piece A on the ceiling using the same piece as a guide.



With the help of a drill, make the two corresponding holes with a $\text{Ø}8$ mm drill bit.

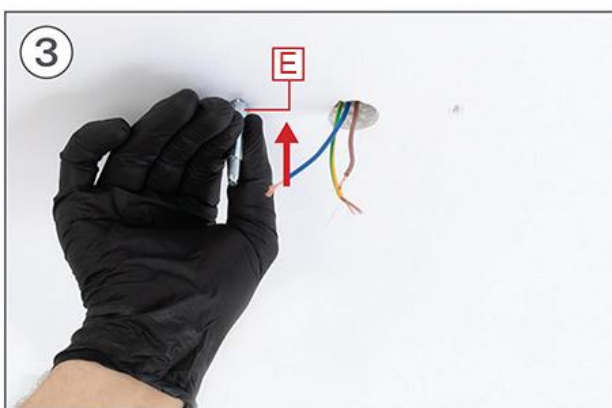

Place the pieces E in the holes in the ceiling.



Only the part of the thread should protrude.

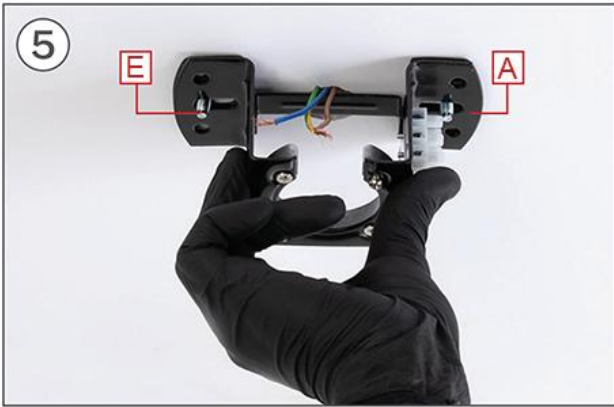

Place the part A matching its holes with the screws E . Make sure the ceiling cables are to one side of the piece E.



Enter pieces E2, E3 and then the nut E4 in order.

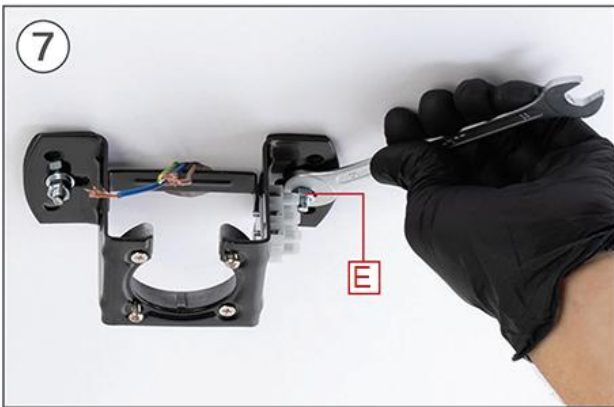

Tighten the piece E4 with a # 10 wrench, until you feel it is tight.

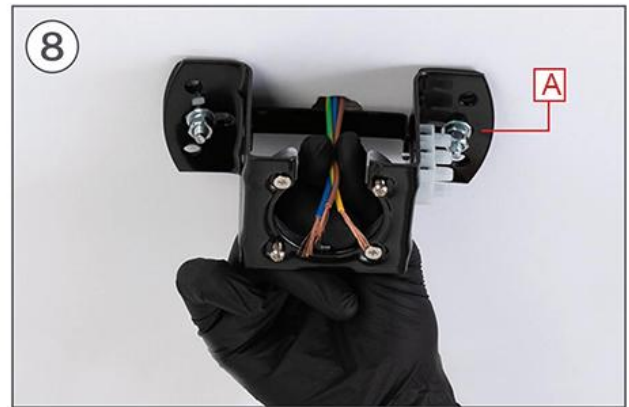

Make sure the piece A is perfectly hooked to the ceiling and that no cables are trapped.

STEP 6: Connect the power cord

M

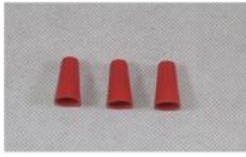

EQUIPMENT NOT INCLUDE

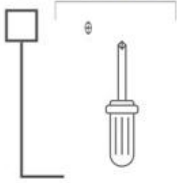

Method 1

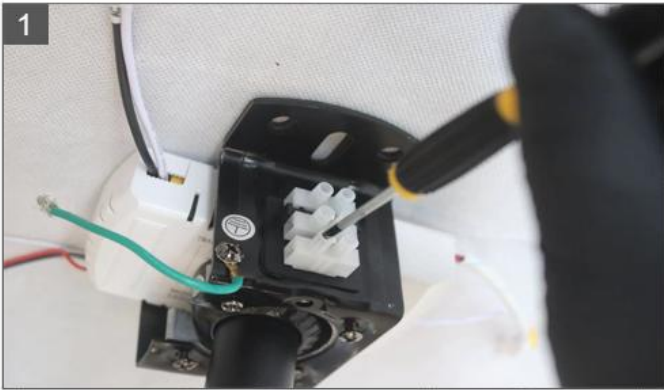

Loosen the bracket * wiring port 6 screws



Connect the live wire (L), neutral wire (N), and ground wire (E) according to the corresponding symbols (L, N, E) on the power cord

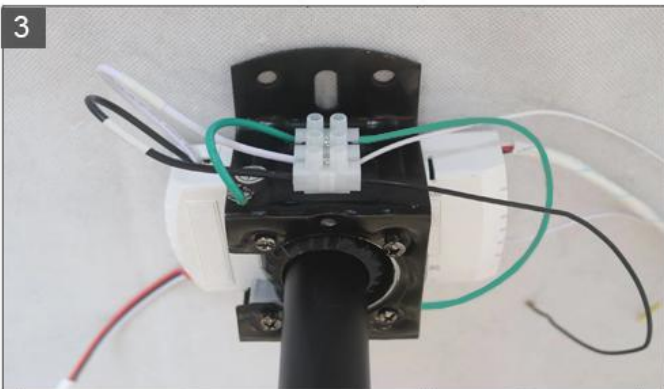

Insert the power cords into the corresponding interfaces for connection



Tighten the 6 screws that were loosened in step 1 one by one, and the power cord connection is complete

Method 2

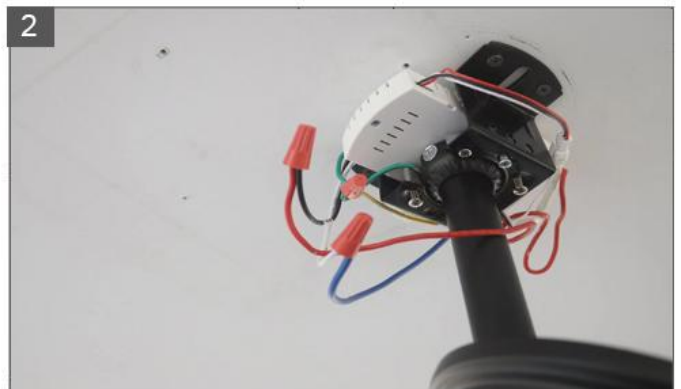
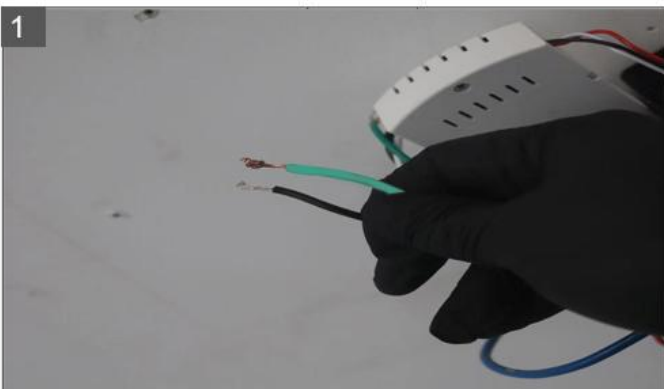

Connect the live wire (L), neutral wire (N), and ground wire (E) according to the corresponding symbols (L, N, E) on the power cord. Connect the power cords separately through the wiring caps

STEP 7: Fixing the canopy

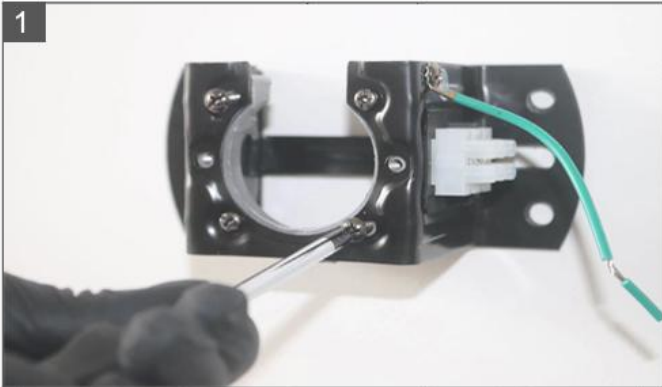

1
First, loosen the two screws at the diagonal of the bracket by 5-6 turns



2
Slide the canopy up to the ceiling. Rotation locked

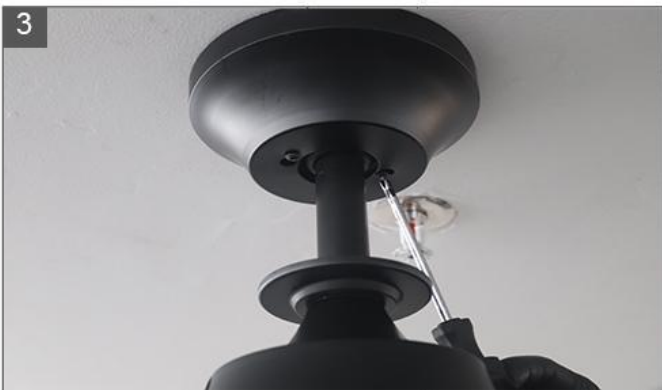

3
Tighten the screws to secure it, and push N all the way up to cover the screws.



5
Connect the lampshade to the motor and slowly rotate it to the right until it is fixed



6
Complete the installation

Inverter fan light remote control

DC variable frequency fan light remote control manual

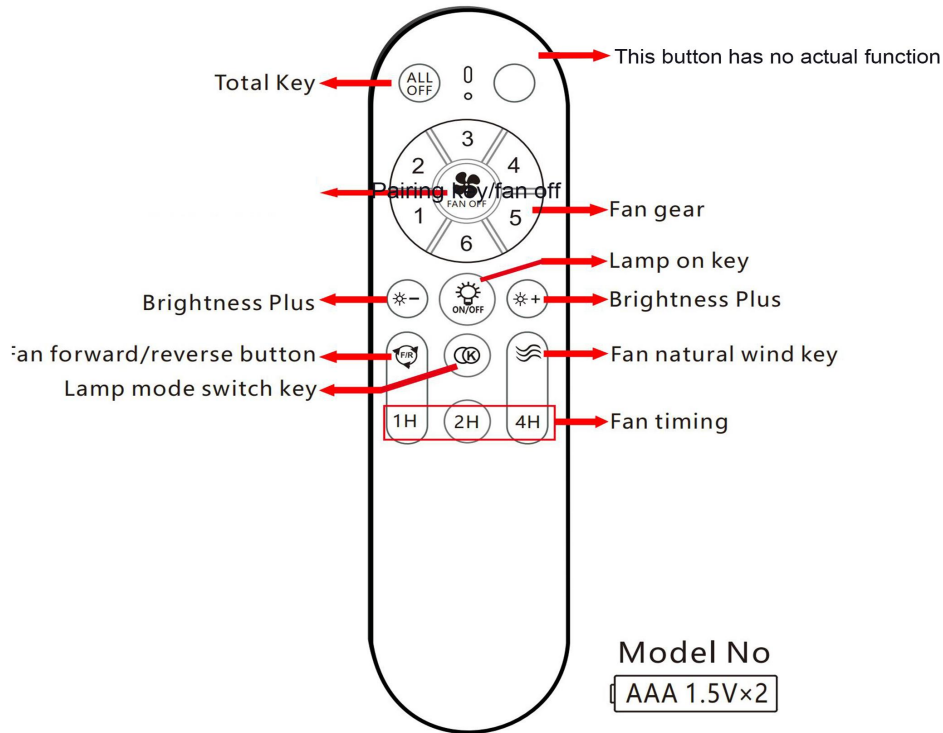

Pairing: Turn on the power switch, press and hold the 'Fan off' button for 3 seconds, and the controller light will flash '3 times', indicating successful pairing.

If unsuccessful, please turn off the power and wait for one minute to repeat the above operation.

When the remote control cannot be effectively controlled: Please check the battery and remove it if it is not in use for a long time.

Introduction to APP control

How to download and install the APP:

①. Scan the QR code, download the "FanLamp Pro" APP.

②. Press "+" button, add a new device.

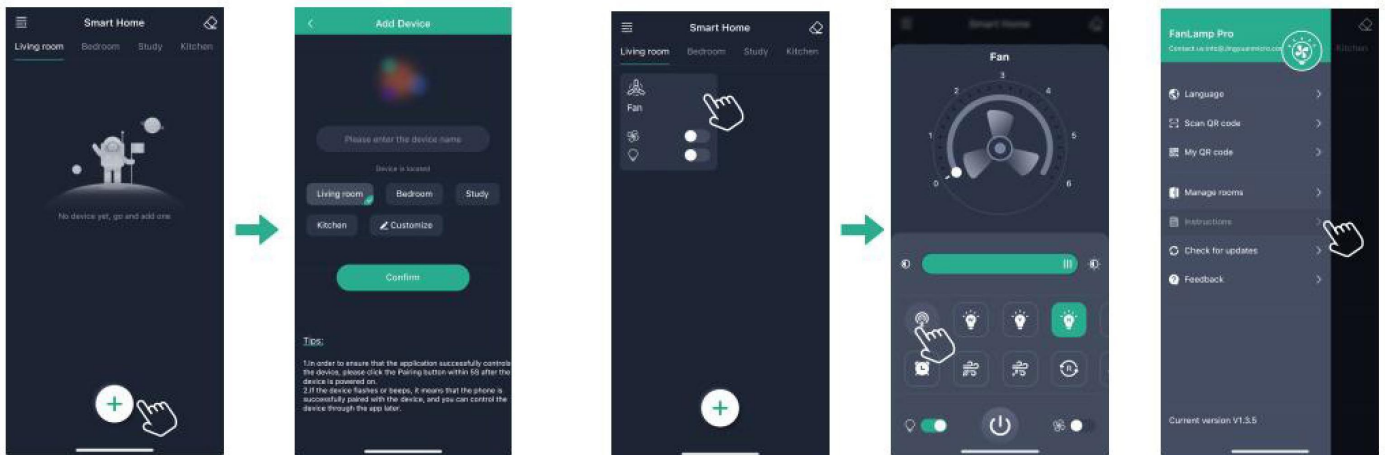

③. Please click this button  within 3 to 5 seconds after the device is powered on. The device will flash, indicating that the phone has been successfully paired with the device, and then the device can be controlled through the application.

④. Press Instructions for more information.



WeChat
small program



Mobile APP
Scan and download the app

Energy Saving Usage

Ceiling fan performance and energy savings rely heavily on the proper installation and use of the ceiling fan. Here are a few tips to ensure efficient product performance.

Choosing the Appropriate Mounting Location

Ceiling fans should be installed or mounted in the middle of the room and positioned at least 7 feet above the floor and 18 inches away from the walls. If the ceiling height allows, it is recommended to install the fan 7~9 feet above the floor to achieve optimal airflow.

Turn Off When Not in the Room

If the room is unoccupied, turn off the ceiling fan to save energy.

Using the Ceiling Fan Year Round

Summer Season: Use the ceiling fan in the counterclockwise direction. The airflow created by the ceiling fan produces a wind-chill effect, making you feel cooler. Select a fan speed that provides a comfortable breeze; lower speeds consume less energy.

Winter Season: Reverse the motor and operate the ceiling fan at a low speed in the clockwise direction. This produces a gentle updraft, which pushes the warm air near the ceiling down into the occupied space. Remember to adjust your thermostat when using your ceiling fan. This simple step can lead to additional energy and cost savings.

Trouble shooting

PROBLEM	SUGGESTED REMEDY
<p>If Fan Does Not Start</p>	<p>1. Check the main and branch circuit fuses or circuit breakers. 2. Ensure that the wall control is turned "ON", do not use dimmer switch. 3. Check the line wire connections to the fan and switch wire connections in the switch housing. CAUTION: Make sure to turn off the main power before making any electrical connections.</p>
<p>If The Fan Sounds Noisy</p>	<p>1. Make sure all screws in the motor housing are snug (not over tightened). 2. Check that wire connectors in the switch housing are not rattling against each other or the interior wall of the switch housing. CAUTION: Turn off the main power before entering the switch housing. 3. Ensure that the screws securing are tight. Make sure the light bulb is tight in the socket and not touching the lamp frame or blades. 4. Note that some fan motors are sensitive to signals from Solid State variable speed controls. DO NOT USE a Solid State variable speed control. 5. Allow a "break-in" period of 24 hours. Most noises associated with a new fan will disappear after this period.</p>
<p>If Fan Wobbles</p>	<p>1. Check that all blades are screwed firmly into blade holders. 2. Make sure that the canopy and mounting plate are tightened securely to the ceiling junction box, and the junction box is mounted firmly to the ceiling joist. 3. Ensure the concave groove of the hanger ball is positioned on the hanger lug of the mounting bracket.</p>
<p>If Light Does Not Work</p>	<p>1. Check the wiring of motor to receiver, and receiver to AC input. 2. Check for loose or disconnected wires in the fan switch housing. 3. Check for loose for LED board. CAUTION: Make sure the main circuit is turned off before entering the switch housing.</p>
<p>Remote Does Not Work</p>	<p>1. Battery out of power or not installed correctly; change new AAA battery and ensure well installed. 2. Remote controller not paired, make new pairing with light. (Page.21)</p>



✉ Email: lspmke_service@163.com

MADE IN CHINA