











A		M6x65mm	x4
B		M6x35mm	x4
C		M6x30mm	x2
D		M6x15mm	x20
E			x2
F		M6	x8
G			x1
H			x1
I			x1



# STEP 1

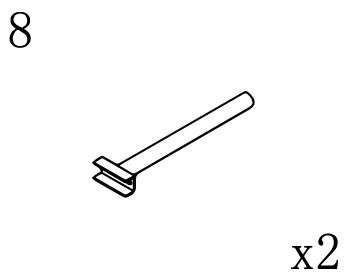
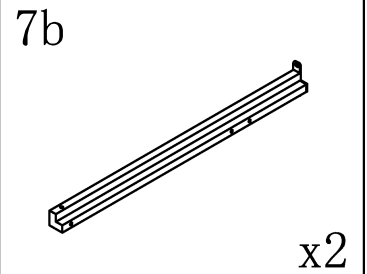
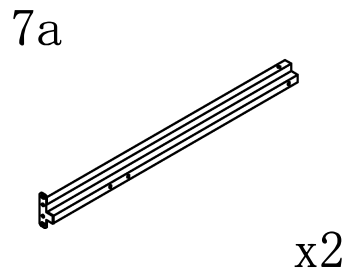
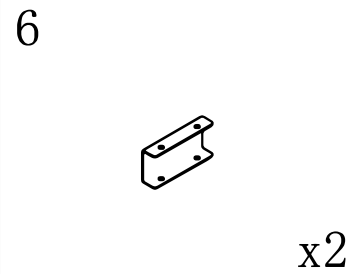
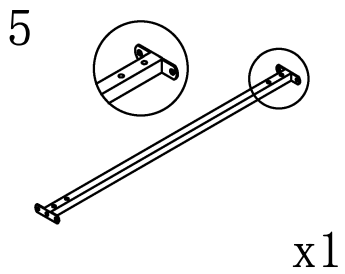
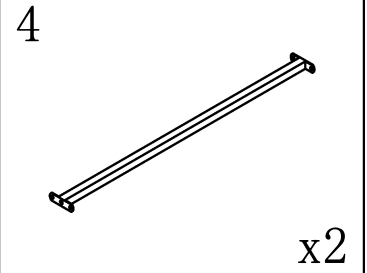
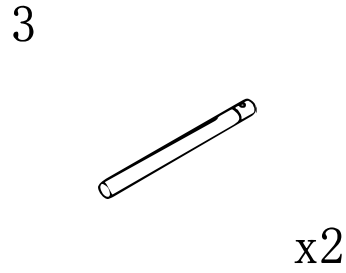
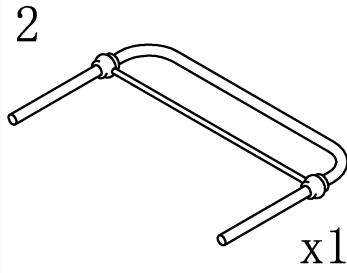
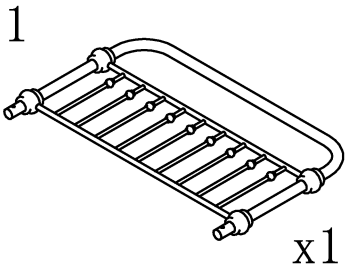
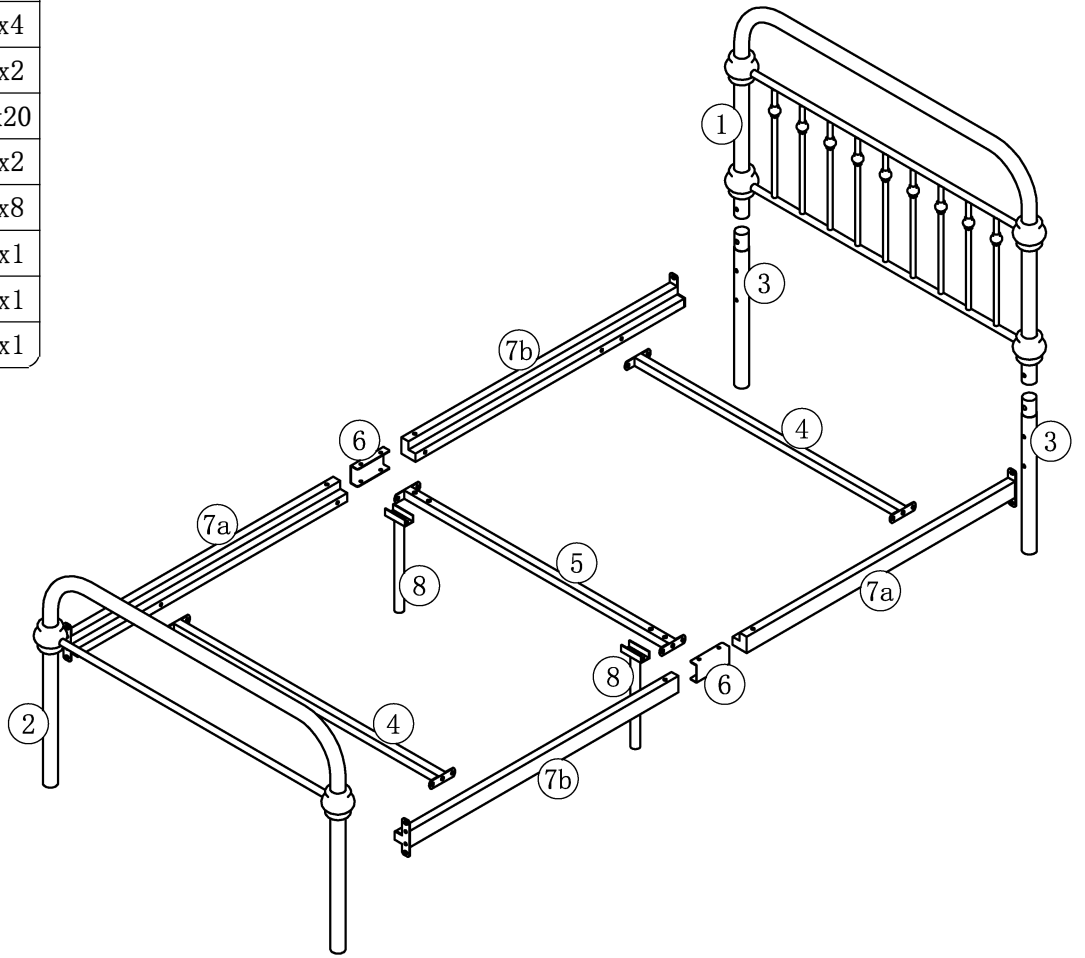
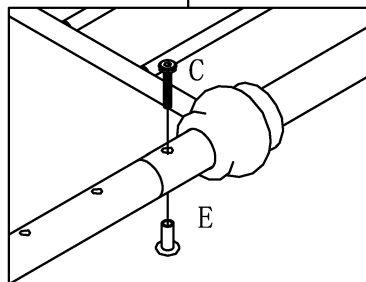
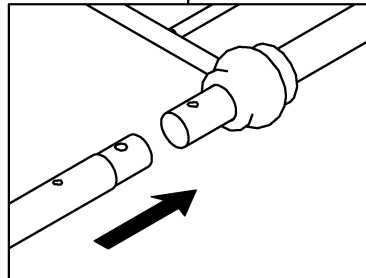
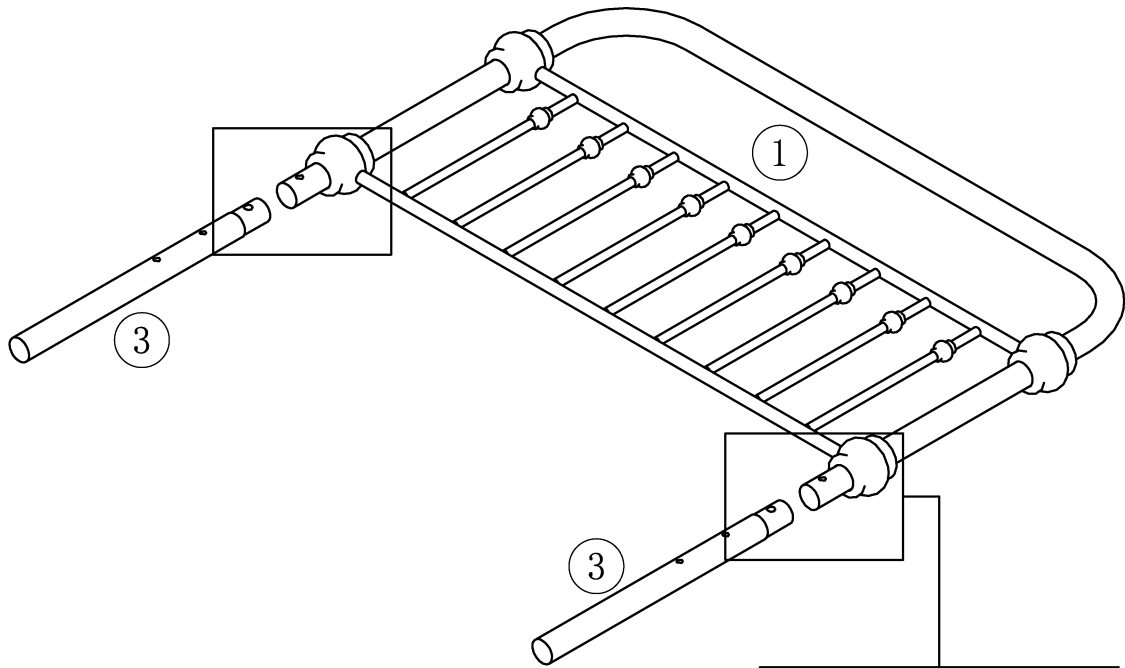

C		x2
E		x2

# STEP 2

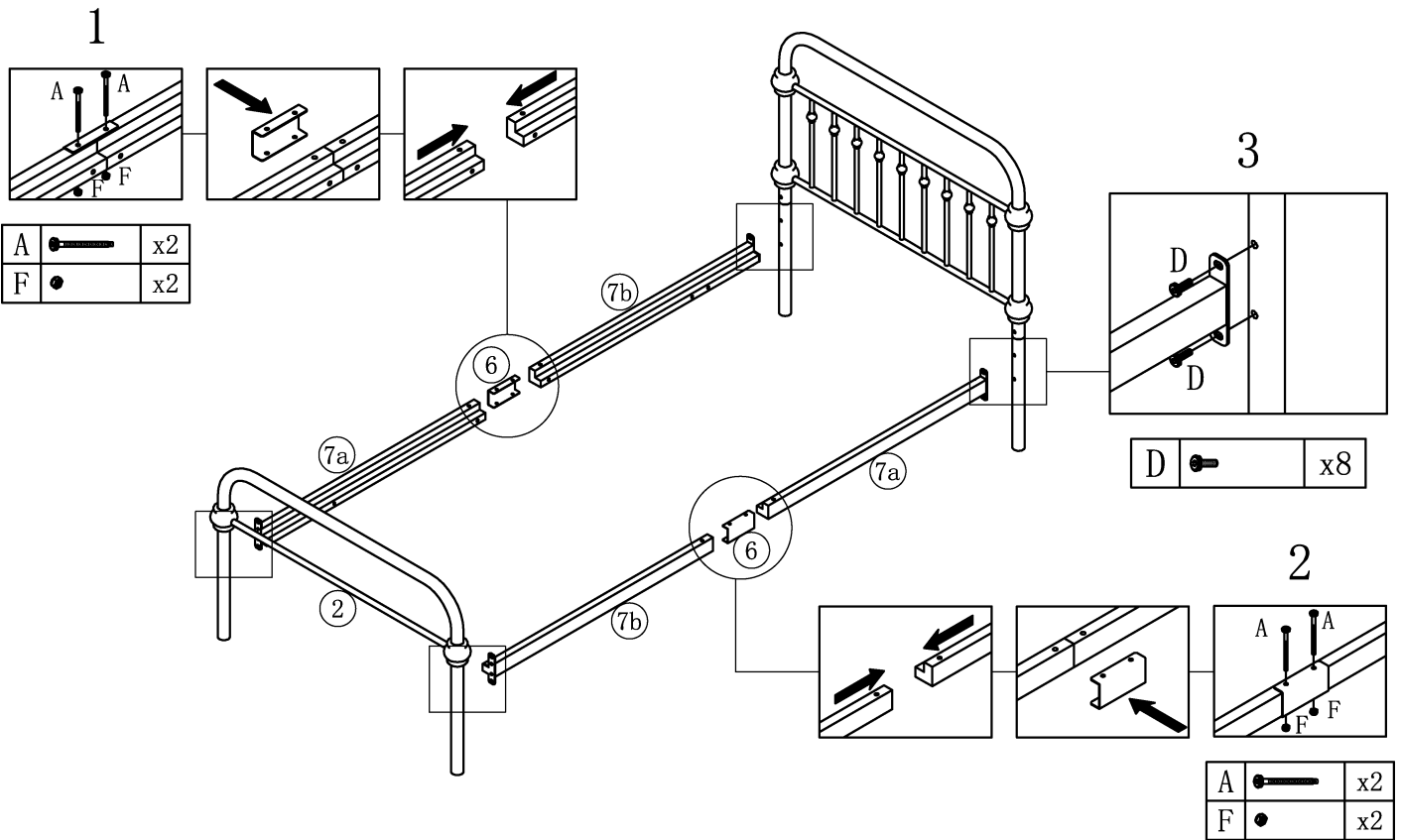

# STEP 3

