

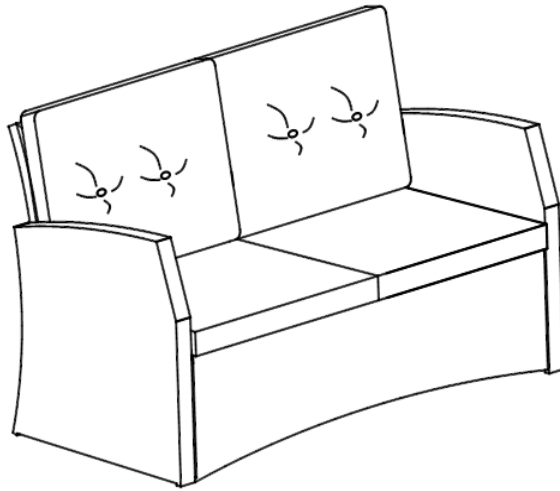



# Assembly Instructions



## Loveseat

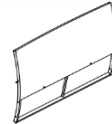
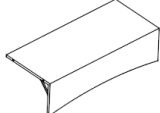
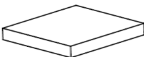

### Parts List

Label	Picture	Description	QTY
A		Left Armrest	1
B		Right Armrest	1
G		Sofa Back	1
H		Sofa Seat	1
I		Seat Cushion	2
J		Back Cushion	2

# Hardware

Label	Picture	Description	QTY
①		Bolt (M6*40mm)	13
②		Washer Rings	13
③		Allen Key	1

## Assembly Preparation

Before Beginning Assembly:

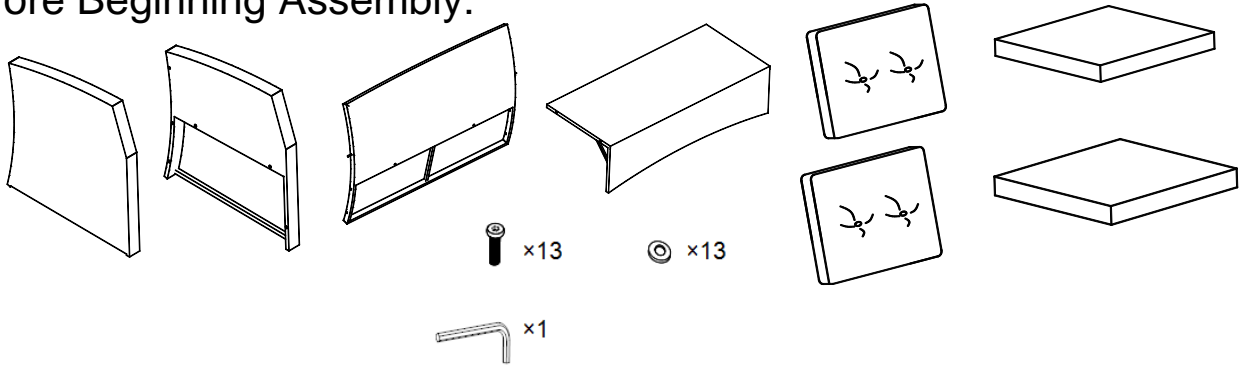

- Read instructions, cover to cover-



- Have 2 adults on hand for assembly-



- Do not assemble on flooring or carpet-



- Assemble on a clean non-marring surface (packing foam)-



- Save all packaging until finished-

## Assembly Steps

### Overview

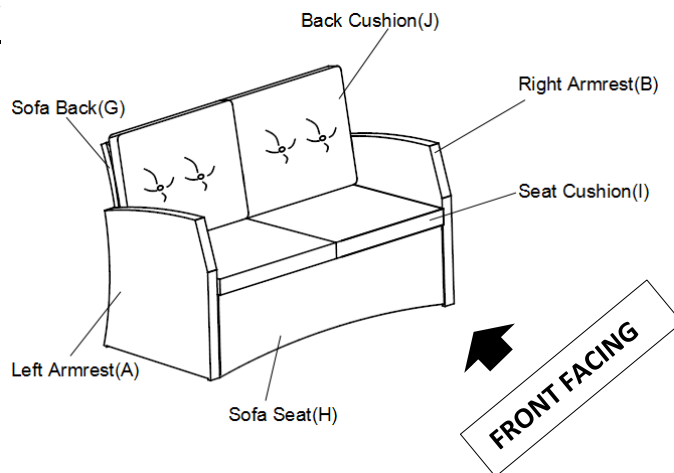

This Love Seat has multiple parts and may require up to some 30 minutes to assemble. To give you an overview of the Love Seat parts, the above picture is to help you put the various parts into perspective. Please read through the instructions here below to familiarise yourself with the parts and steps before assembly.

## Step 1

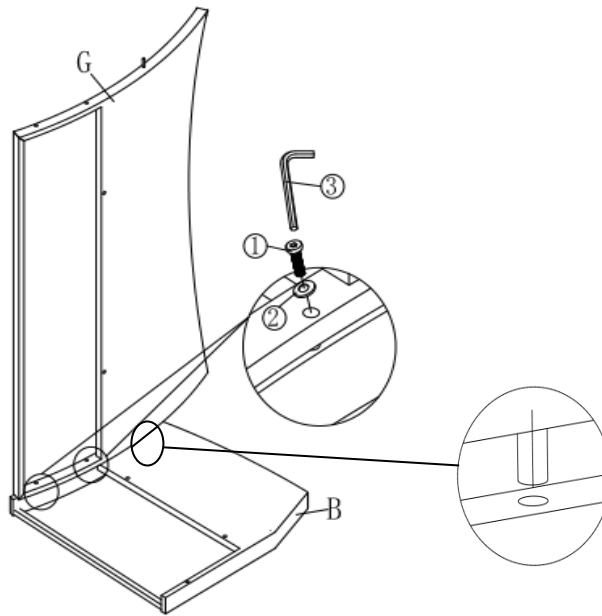

Open the carton and place all the parts onto a clean and soft surface.

Unpack all packages of hardware.

Place the Sofa Back (G) to Right Armrest (B), make the metal rod on the Sofa Back (G) insert into the mounting position.

Attach the Sofa Back (G) and Right Armrest (B) together using Bolts (①) and Washers (②) with Allen Key (③) as shown in Picture.

**DO NOT FULLY TIGHTEN THE BOLTS.**

**ATTENTION: There may be some PE wicker that may have covered the bolt points. To ease assembly, guide and slide the PE wicker away from the mounting positions. DO NOT CUT AWAY any PE WICKER as this would cause the wicker to unravel !**

## Step 2

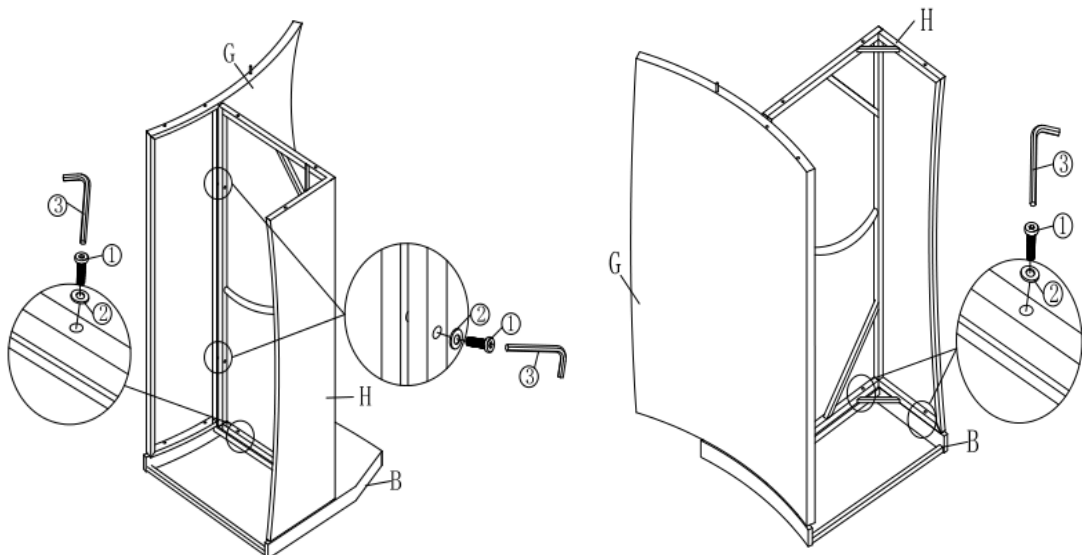

Attach Sofa Seat (H) between the Right Armrest (B) and Sofa Back (G) using Bolts (①) and Washers (②) with Allen Key (③) as shown in Picture.

**DO NOT FULLY TIGHTEN THE BOLTS.**

### Step 3

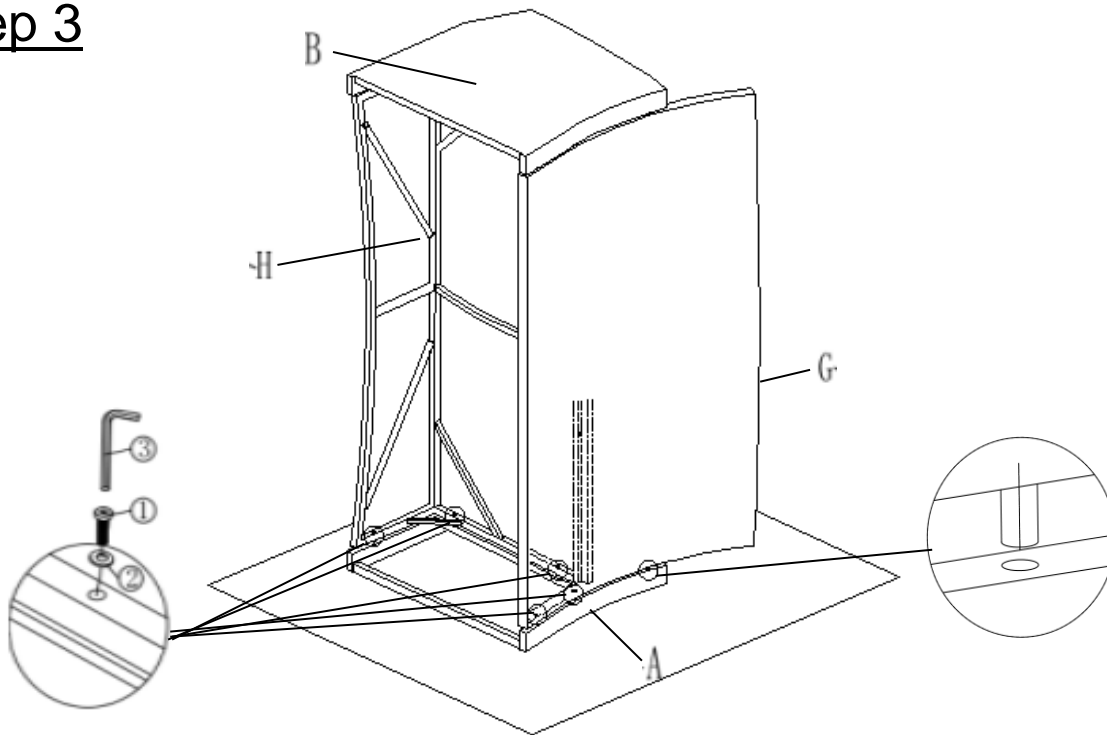

Attach Left Armrest(A) between the Sofa Seat (H) and Sofa Back (G) using Bolts (①) and Washers (②) with Allen Key (③) as shown in Picture.

**DO NOT FULLY TIGHTEN THE BOLTS.**

### Step 4

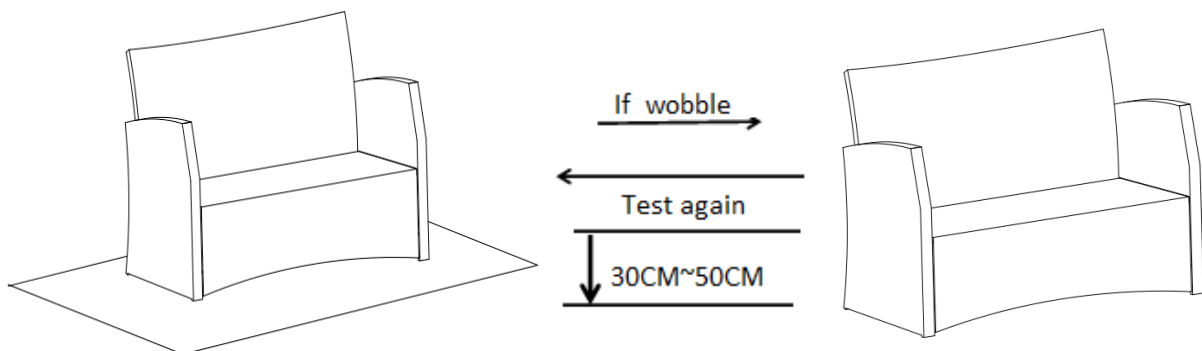

Turn the Loveseat right side up.

Place the Loveseat on a **LEVEL SURFACE** to check for wobbles.

If it wobbles, lift the Loveseat some 30cm to 50cm high from the ground.

Keep your feet and toes well away from the drop zone.

Drop the Loveseat freely and vertically with all four legs, hitting the ground, all at the same time.

This drop test will help to ensure that all the bolts and gaps reach full alignment status.

Test again for eveness on a **LEVEL SURFACE**.

If no wobbles are found, slowly and steadily, place the Loveseat face down.

Then, proceed to tighten all bolts in a sequential manner.

When tightening the Bolts, tighten sequentially.

**DO NOT tighten any Bolt fully and then move on to the next one.**

This may cause the frame to warp.

If there is still wobbles, loosen the bolts and execute this same process.

**If the Loveseat is not stable it could lead to damage to the product.**

## Step 5

BackCushion(J)

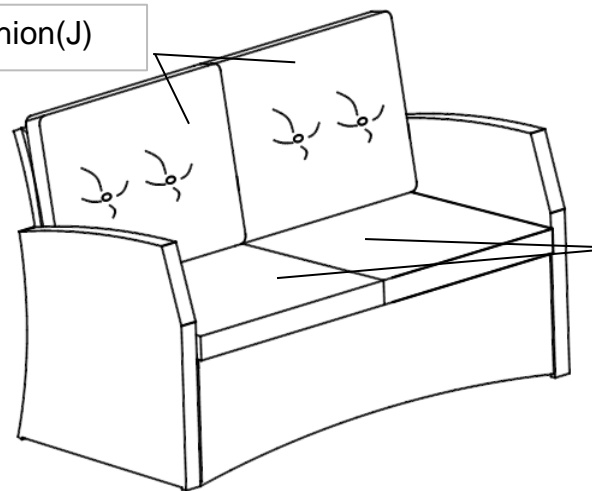





















Seat Cushion(I)

Put the Seat Cushion(I) and Back Cushion(J) on the Loveseat.  
Your Loveseat is ready for use.

**This Loveseat can only be used on the flat and level surface.**

## Care & Maintenance

-   ● Do not put hot items directly on furniture surface
  -   ● Do not clean furniture with harsh cleansers or polish.
  -   ● To obtain the longest lifespan of your outdoor products, minimizing exposure to direct sunlight is recommended.
  -   ● Children should not climb or jump on the furniture.
  -   ● Do not write on furniture without a padded barrier to protect the surface.
  -   ● To obtain the longest lifespan of your outdoor products, avoid extended and lengthy exposure to rain, snow, and direct sunshine. Whenever possible cover the product and /or place under patio or awnings.
  -   ● Not for commercial use. For residential use only .
  -   ● Stains may be removed with mild soap solution and damp cloth.
  -   ● Keep away from sources of ignition.
- 
-   ● Dust and pick-up spills using a clean, non-colored, lint-free cloth.

### Questions & Answers about Proposition 65

#### • What is Proposition 65?

Proposition 65 requires businesses to provide warnings to Californians about significant exposures to chemicals that cause cancer, birth defects or other reproductive harm. These chemicals can be in the products that Californians purchase, in their homes or workplaces, or that are released into the environment. By requiring that this information be provided, Proposition 65 enables Californians to make informed decisions about their exposures to these chemicals.

Proposition 65 also prohibits California businesses from knowingly discharging significant amounts of listed chemicals into sources of drinking water.

Proposition 65 requires California to publish a list of chemicals known to cause cancer, birth defects or other reproductive harm. This list, which must be updated at least once a year, has grown to include approximately 900 chemicals since it was first published in 1987.

#### • What types of chemicals are on the Proposition 65 list?

The list contains a wide range of naturally occurring and synthetic chemicals that include additives or ingredients in pesticides, common household products, food, drugs, dyes, or solvents. Listed chemicals may also be used in manufacturing and construction, or they may be byproducts of chemical processes, such as motor vehicle exhaust.

#### • What does a warning mean?

If a warning is placed on a product label or posted or distributed at a workplace, a business, or in rental housing, the business issuing the warning is aware or believes that it is exposing individuals to one or more listed chemicals.

By law, a warning must be given for listed chemicals unless the exposure is low enough to pose no significant risk of cancer or is significantly below levels observed to cause birth defects or other reproductive harm.

#### • Where can I get more information on Proposition 65?

If you have specific questions on the administration or implementation of Proposition 65, you can contact OEHHA's Proposition 65 program at [P65.Questions@oehha.ca.gov](mailto:P65.Questions@oehha.ca.gov), or by phone at (916) 445-6900.