





Assembly Instruction

Product Description: Stuart end Table

Hardware and Component List:

No.	Hardware/Component List		Quantity
1		Table Top	01
2		Base	01
3		Allen Bolt M8X40MM	04
4		Washer 10X25MM	04
5		Allen Key 5MM	01

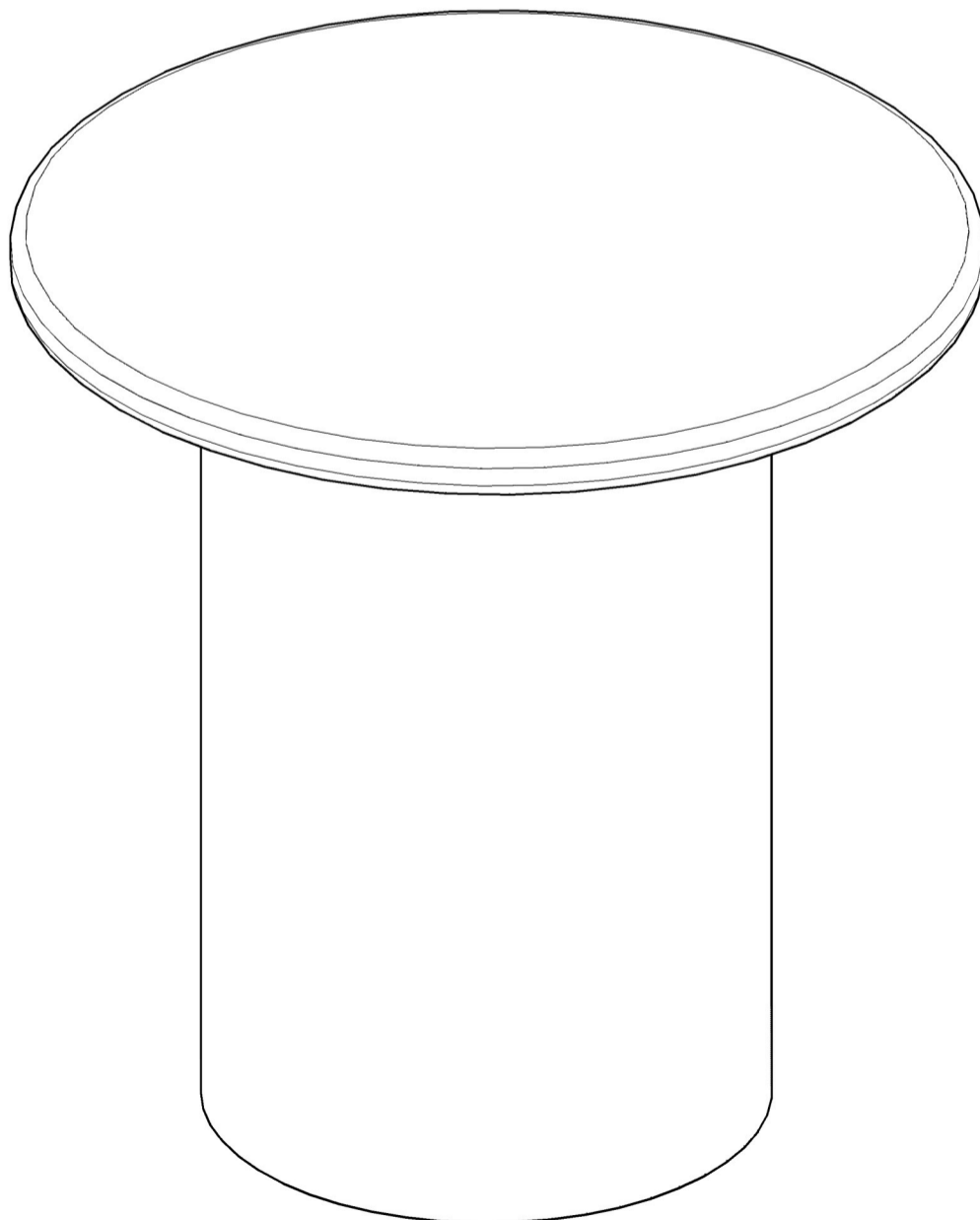

Assembly Instruction
Product Description: Stuart end Table

1

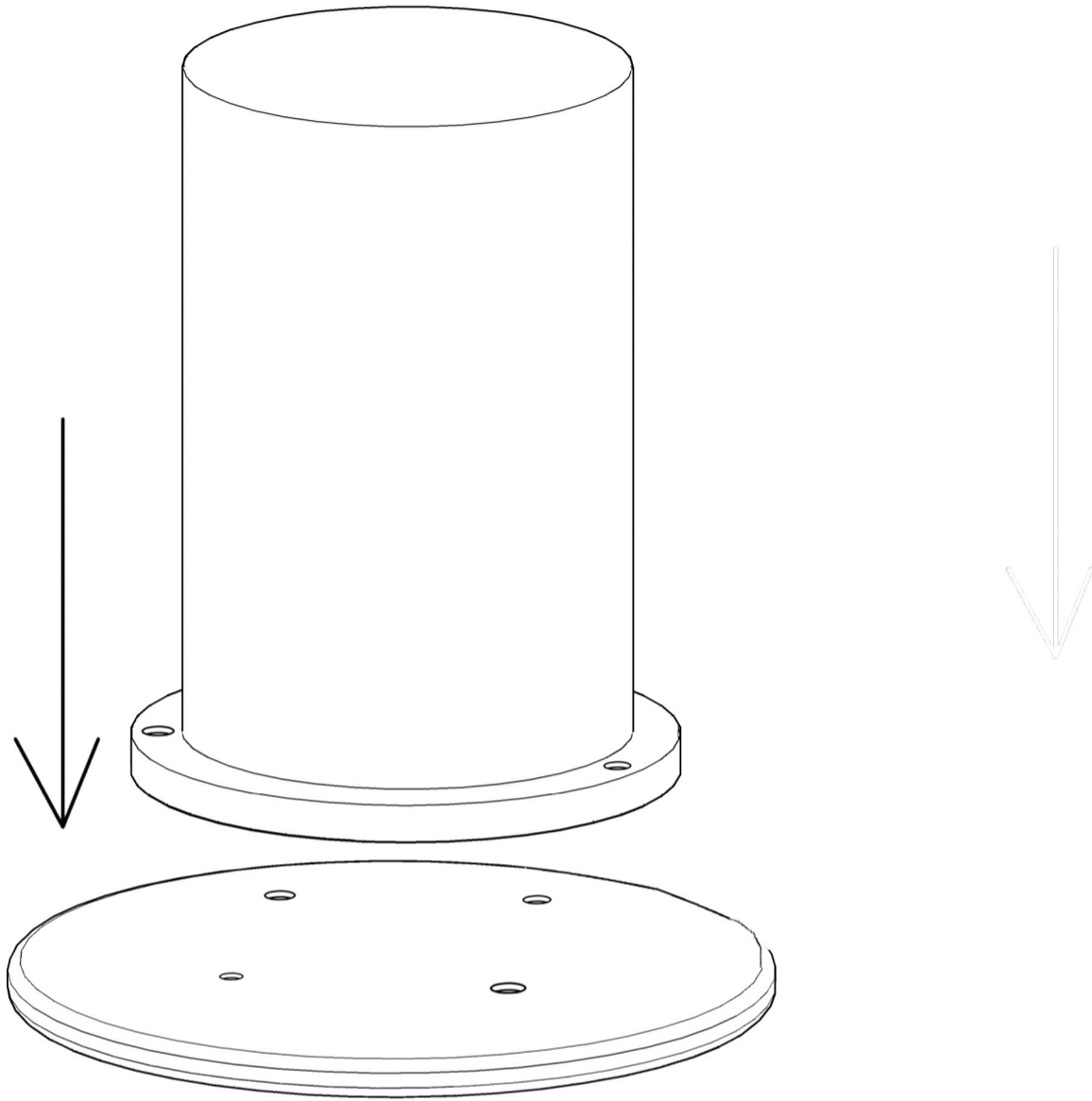

2

