

USE AND CARE GUIDE



01 Table of Contents

Safety Information	01	Remote control manual	06
Warranty	02	Fans Balance	07
Three ceiling installation methods	03	Care and cleaning	08
Accessory drawing	04	Trouble shooting	08
Installation procedure	05	Connect to mobile app and user manual	09

02 Safety Information

READ ALL SAFETY INFORMATION AND INSTALLATION INSTRUCTIONS BEFORE YOU BEGIN INSTALLING THE FAN AND SAME INSTRUCTIONS.



Warning:
Kindly turn off the power when connecting cables.

1. To reduce the risk of electric shock, ensure the electricity has been turned off at the circuit breaker or fuse box before you begin.
2. All wiring must be in accordance with the National Electrical Code ANSI/NFPA 70-1999 and local electrical codes. Electrical installation should be performed by a qualified licensed electrician.
3. The outlet box and support structure must be securely mounted and capable of reliably supporting 35 lbs. (15.9 kg) Use only UL Listed outlet boxes marked "Acceptable for Fan Support of 35 lbs. (15.9 kg) or less".
4. The fan must be mounted with a minimum of 7 ft. (2.1 m) clearance from the trailing edge of the blades to the floor.
5. Do not place objects in the path of the blades.
6. To avoid personal injury or damage to the fan and other items, use caution when working around or cleaning the fan
7. Electrical diagrams are for reference only. Light kits that are not packed with the fan must be UL-listed and marked suitable for use with the model fan you are installing. Switches must be UL General Use Switches. Refer to the instructions packaged with the light kits and switches for proper assembly.
8. After making electrical connections, spliced conductors should be turned upward and pushed carefully up into the outlet box. The wires should be spread apart with the grounded conductor and the equipment-grounding conductor on one side of the outlet box.
9. All set screws must be checked and re-tightened where necessary before installation.

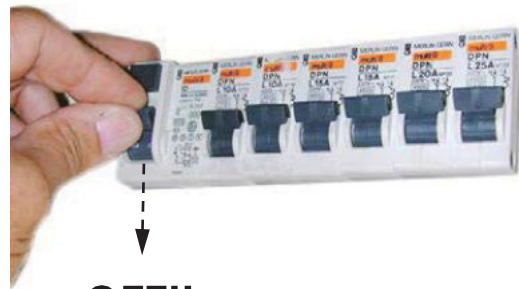

OFF!!



WARNING: To reduce the risk of personal injury, do not bend the blade brackets (also referred to as flanges) during assembly or after installation. Do not insert objects in the path of the blades.



WARNING: To reduce the risk of fire or electric shock, this fan is NOT suitable for use with solid-state speed controls.



WARNING: To avoid possible electrical shock, make sure that the electricity is turned off at the main power box before starting work. If you feel you do not have enough electrical wiring knowledge or experience, contact a licensed electrician.



WARNING: Electrical diagrams are for reference only. Optional use of any light kit shall be UL-listed and marked suitable for use with this fan



WARNING: To reduce the risk of fire, electrical shock or personal injury, ensure that the fan mounting bracket is supported directly from the building structure or the outlet box marked "Acceptable for Fan Support of 35 lbs. (15.9 kg) or less". Use only the screws provided with the outlet box.

03 Warranty

The supplier warrants the fan motor to be free from defects in workmanship and material present at time of shipment from the factory for a lifetime after the date of purchase by the original purchaser. The supplier also warrants that all other fan parts, excluding any glass or acrylic blades, to be free from defects in workmanship and material at the time.

of shipment from the factory for a period of two years after the date of purchase by the original purchaser. We agree to correct such defects without charge or at our option replace with a comparable or superior model if the product is returned.

To obtain warranty service, you must present a copy of the receipt as proof of purchase. All costs of removing and re-installing the product are your responsibility. Damage to any part such as by accident, misuse, improper installation, or by affixing any accessories, is not covered by this warranty.

Because of varying climatic conditions this warranty does not cover any changes in brass finish, including rusting, pitting, corroding, tarnishing, or peeling. Brass finishes of this type give their longest useful life when protected from varying weather conditions. A certain amount of "wobble" is normal and should not be considered a defect.

Servicing performed by unauthorized persons shall render the warranty invalid. There is no other express warranty. hereby disclaims any and all warranties, including but not limited to those of merchant ability and fitness for a particular purpose to the extent permitted by law. The duration of any implied warranty which cannot be disclaimed is limited to the time period as specified in the express warranty. Some states do not allow a limitation on how long an implied warranty lasts, so the above limitation may not apply to you.

The retailer shall not be liable for incidental, consequential, or special damages arising out of or in connection with product use or performance except as may otherwise be accorded by law. Some states do not allow the exclusion of incidental or consequential damages, so the above exclusion or limitation may not apply to you. This warranty gives specific legal rights, and you may also have other rights which vary from state to state. This warranty supersedes all prior warranties. Shipping costs for any return of product as part of a claim on the warranty must be paid by the customer.

04 Three ceiling installation methods

WOODEN CEILING

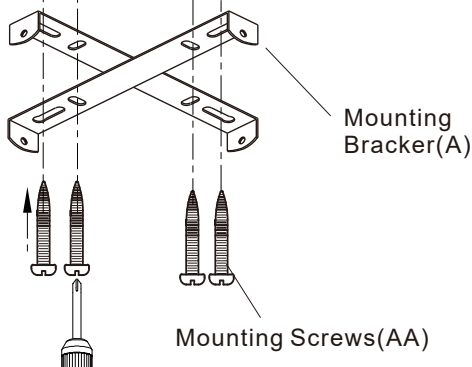

For wooden ceiling, use wood screw to drill on the wooden beam or the "junction box" to fix the hanging bracket (selection is made according to actual requirements of the customers).

STEP 1A-WOODEN CEILING

SWITCH OFF THE ELECTRICAL MAINS AT THE CIRCUIT BREAKER FUSE BOX.

- 1) Use the Mounting Bracket (A) as a guide, mark the spots where the 4 Self Mounting Screws (AA) will be drilled.
- 2) Remove the Mounting Bracket (A), drill 4 holes for 3MM diameter, install the mounting bracket onto wooden ceiling with the 4 Self Mounting Screws (AA).

⚠ IMPORTANT :SCREWS MUST BE TIGHTENED TILL SNUG

CONCRETE CEILING

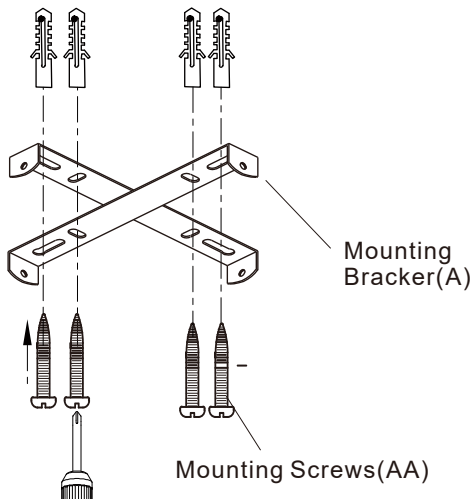

For concrete ceiling, use the percussion bit with diameter 6mm to drill holes according to the length of plugs. Then use the attached plugs to fix the hanging bracket onto the ceiling

STEP 2A-CONCRETE CEILING

SWITCH OFF THE ELECTRICAL MAINS AT THE CIRCUIT BREAKER FUSE BOX.

- 1) Use the Mounting Bracket (A) as a guide, mark the spots where the 4 Plugs(BB) will be drilled.
- 2) Remove the Mounting Bracket (A). Drill 4 holes for 6MM diameter and insert 4 Plugs (BB) into the concrete ceiling, install the mounting bracket and secure with Flat Mounting screws (AA)

⚠ IMPORTANT :SCREWS MUST BE TIGHTENED TILL SNUG

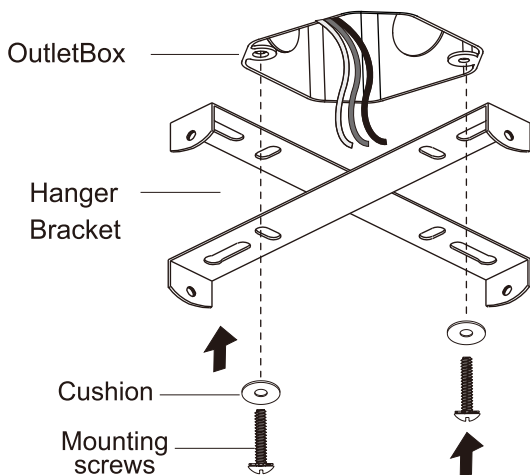

Tighten the hanger bracket to the outlet box with 2 mounting screws. (To reduce the risk of fire, electric shock, or personal injury, mount to the outlet box marked "Acceptable for fan support" and use mounting screws provided with the outlet box.)

05 Accessory drawing

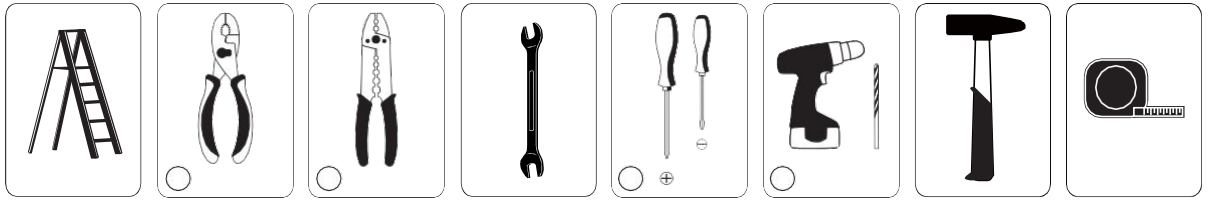

06 Installation procedure

1. Use the groove of the hanging board to rotate and remove the hanging board.



2. Install the hanging panel on the ceiling and tighten the screws.



3. Using nuts, connect the fan live wire (black) to your house live wire; Connect the fan neutral wire (white) to your house neutral wire.

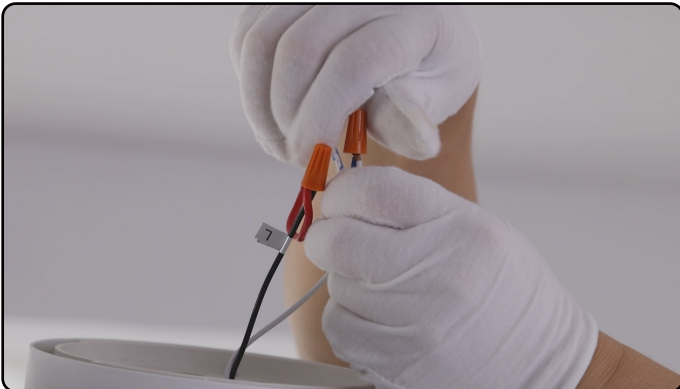

4.4. Install the fan on the hanging plate, rotate the fan until it can no longer rotate, and make it completely enter the groove of the hanging plate..



USER MANUAL FOR REMOTE CONTROL TRANSMITTER

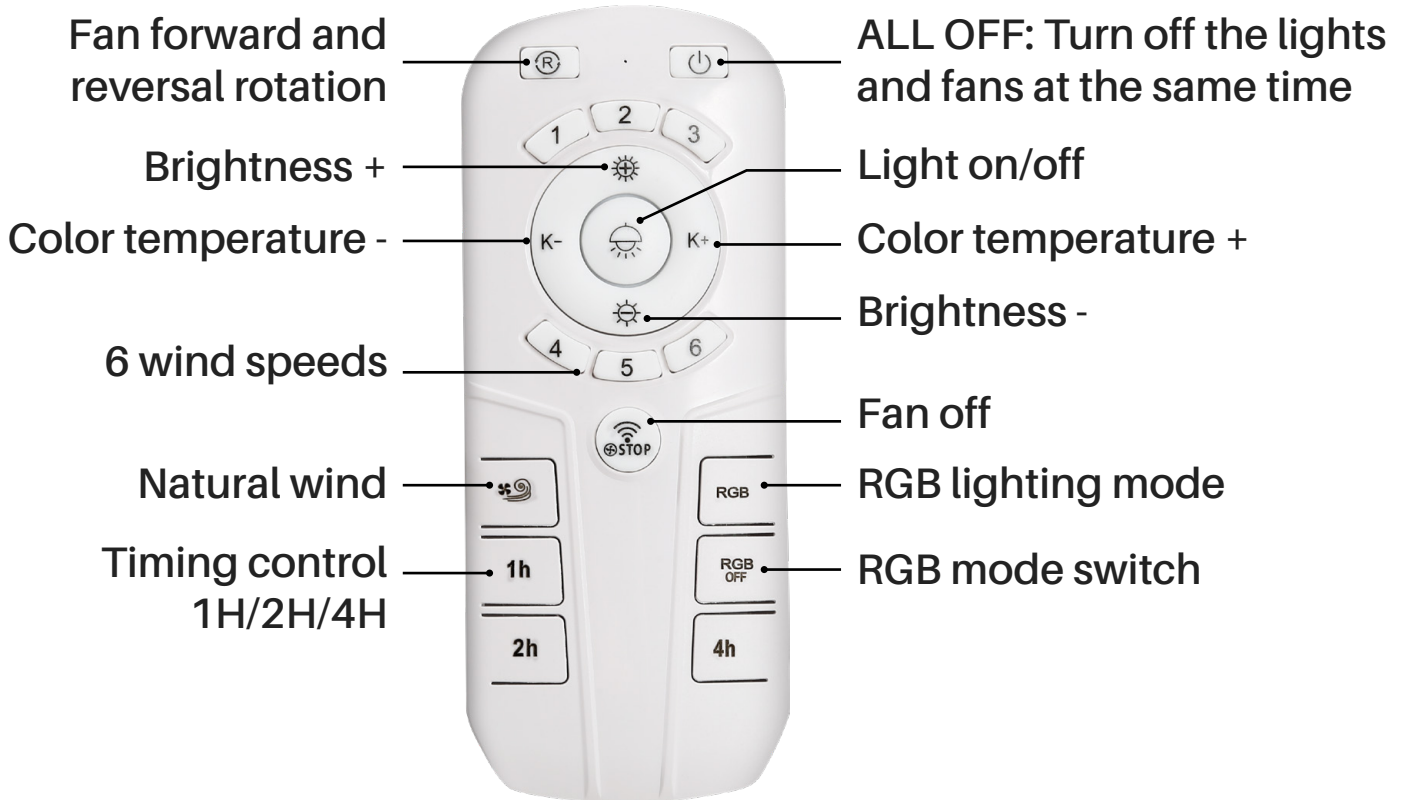

- Match code: Turn off the ceiling fan power switch first, then turn it on again, and then long press the "All OFF" button within 5 seconds.
- Clear Mode: Turn off the ceiling fan power switch first, then turn it on again, and then long press the "Brightness+" and "4" button at the same time within 5 seconds.

Note: the remote control must match the same code receiver



When the reversible button is pressed, the fan slowly slows down to a stop and then begins to reverse.

08 Fans Balance



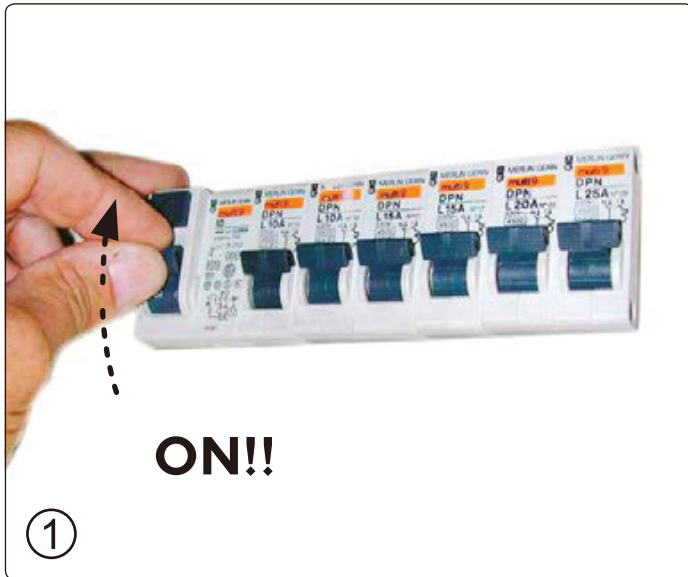

if it does not work



1. Turn on the main switch.



2. Within 5 seconds after power on, long press the  key, the fan stops and the light flashes, indicating that the code is successfully paired.

Clear pairing:
within 5 seconds after power on, long press  and  buttons, the light flashes to clear the code successfully.



3. The pairing is successful when the LED light flashes

07 Care and Cleaning



WARNING: Make sure the power is off before cleaning your fan.

- Because of the fan's natural movement, some connections may become loose. Check the support connections, brackets, and blade attachments twice a year. Make sure they are secure. It is not necessary to remove the fan from the ceiling.
- Clean your fan periodically to help maintain its new appearance over the years. Do not use water when cleaning, as this could damage the motor, or the wood, or possibly cause an electrical shock. Use only a soft brush or lint-free cloth to avoid scratching the finish. The plating is sealed with a lacquer to minimize discoloration or tarnishing.
- You can apply a light coat of furniture polish to the wood for additional protection and enhanced beauty. Cover small scratches with a light application of shoe polish.

The motor has permanently-lubricated sealed ball bearings.

08 Trouble shooting

Problem	Solution
The fan will not start.	<ul style="list-style-type: none">□ Check the main and branch circuit fuses or breakers.□ Check the line wire connections to the fan and switch wire connections in the switch housing.
The fan is noisy.	<ul style="list-style-type: none">□ Ensure all motor housing screws are snug.□ Ensure the screws that attach the fan blade bracket to the motor hub are tight.□ Ensure the wire nut connections are not ratting against each other or the interior wall of the switch housing.□ Allow a 24-hour "breaking in" period. Most noises associated with a new fan disappear during this time.□ If you are using the Ceiling Fan light kit, ensure the screws securing the glassware are tight. Check that the light bulbs are also secure.□ Ensure the canopy is a short distance from the ceiling. It should not touch the ceiling.□ Ensure your outlet box is secure and rubber isolator pads were used between the mounting plate and outlet box.
The fan wobbles.	<ul style="list-style-type: none">□ Please check and follow the instructions: Chapitre No.13 Fan balance on page 16.

Connect to mobile app and user manual

01.How do I download the mobile app?

1.Use your phone to scan this QR code to download the app and install it.
(you can also search for "FanLamp Pro" in the mobile app store and Google Play, and then download it and install it)

02.How to connect the mobile app to the fan?

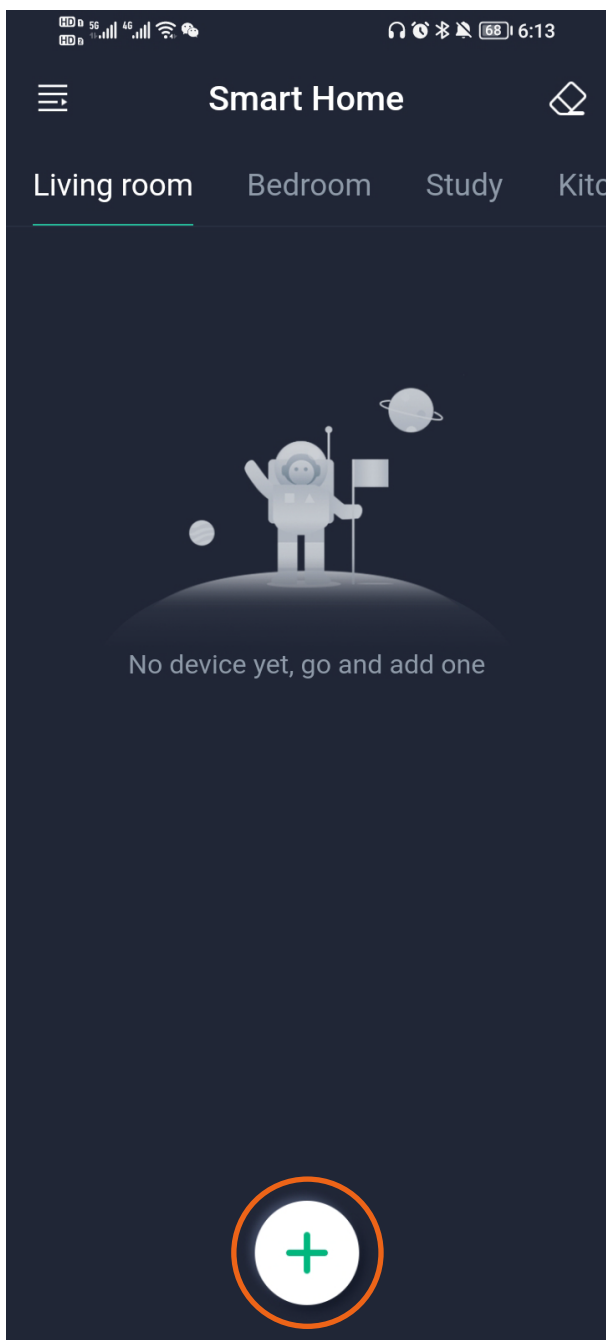

1.Click the plus sign at the bottom to add a device.

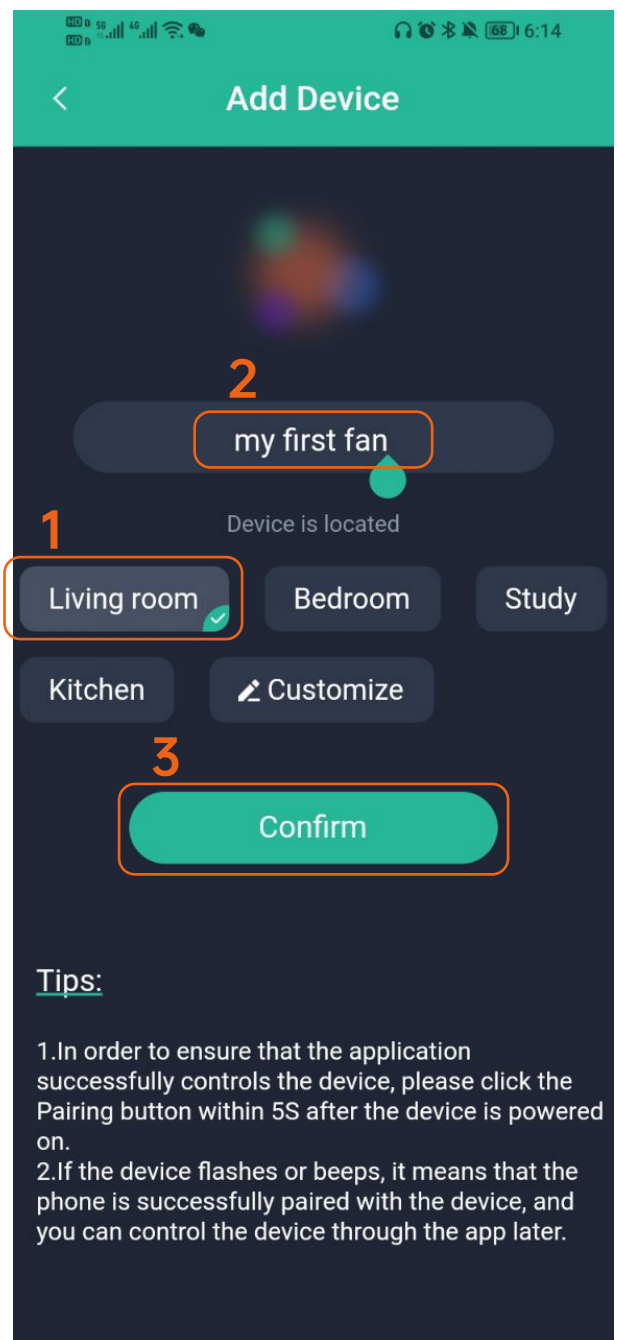

2.Select the room type, give it a name, and click "Confirm".

02.How to connect the mobile app to the fan?

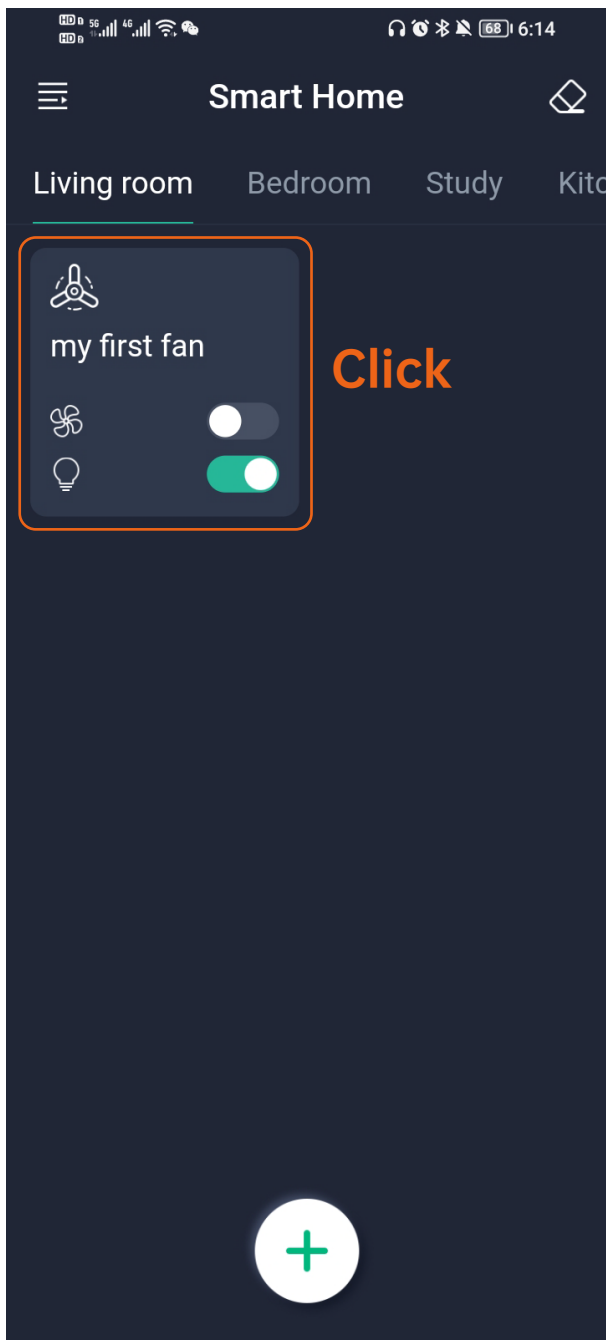

3.Click to enter the device you created.

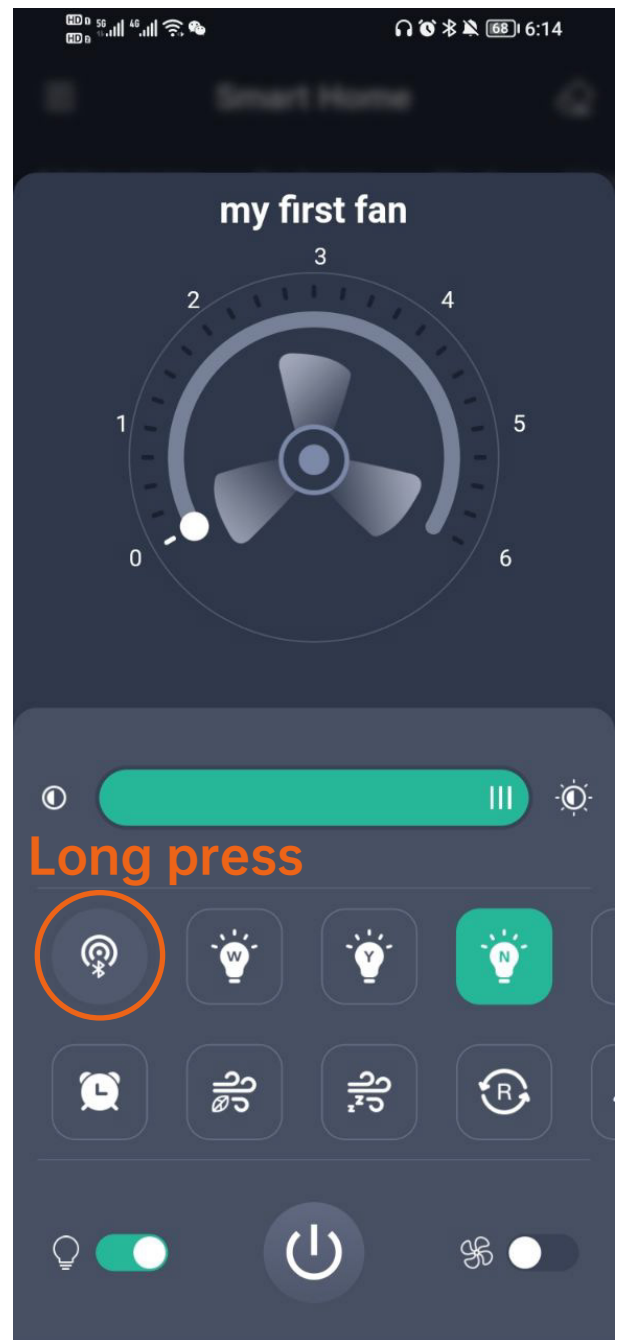

4.When you enter this interface, turn on the fan first, the light will light up, then long press the "🌀" button to turn on Bluetooth, the light will flash, indicating that the pairing is successful.

03.How do I use it to control the fan?

The image shows a mobile app interface for controlling a fan, titled "my first fan". The interface includes a speed dial with 6 wind speeds (0-6), a brightness slider, color temperature controls, and various fan modes like Natural wind, Timing control, and sleeping wind. It also features RGB lighting controls, Bluetooth connection, and a power button. Annotations point to specific features:

- Fan on/off 6 wind speeds
- Brightness adjustment
- Color temperature
- Bluetooth connection
- Natural wind
- Timing control
- sleeping wind
- Light on/off
- Night mode
- RGB lighting mode
- RGB mode on/off
- Fan forward and reversal rotation
- Fan on/off

ALL OFF: Turn off the lights and fans at the same time

