

ASSEMBLY GUIDE

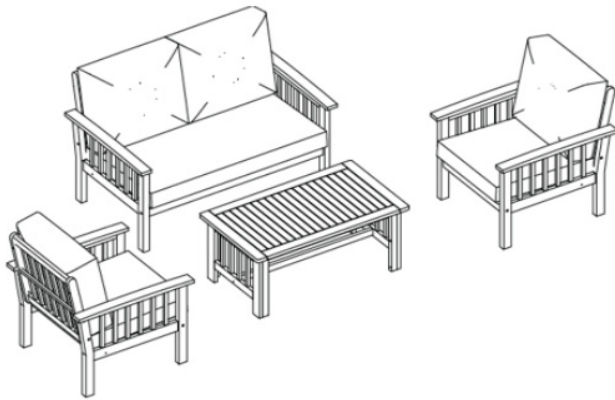

Important - Please read these instructions fully before starting assembly



**SAFETY AND
CARE ADVICE**



NO POWER TOOLS

SAFETY AND CARE ADVICE

- Check you have all the components and tools listed.
- Remove all fittings from the plastic bags and separate them into their groups.
- We do not recommend the use of power drills/drivers for inserting screws, as this could damage the unit. Only use hand screwdrivers and Allen keys.
- Keep children and animals away from the work area, small parts could cause choking if swallowed.
- Make sure you have enough space to lay out the parts before starting.
- Assemble the item as close to its final position as possible.
- Do not overtighten the nuts to avoid causing damage to the threads.
- Only clean using a damp cloth and mild detergent, do not use bleach or abrasive cleaners.
- From time to time check that there are no loose screws on this unit
- This product should not be discarded with household waste. Take to your local authority waste disposal centre

IMPORTANT INFORMATION



30 MINUTE
BUILD













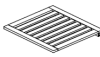

TWO
PERSON



TABLE MAX CAPACITY 75Kg
SOFA MAX CAPACITY 110Kg
CHAIR MAX CAPACITY 110Kg

PLEASE CHECK CAREFULLY AND MAKE SURE YOU HAVE ALL FITTINGS AND TOOLS LISTED BELOW BEFORE YOU START.

Chair Parts

 A x1	 E x1	① Screw (M6x80)  x 2
 B x1	 F x1	② Bolt (M6x45)  x 5
 C x1	 G x1	③ Bolt (M6x60)  x 2
	 H x1	④ Bolt (M6x80)  x 2
		⑤ Caps Nut (M6x18)  x 4
		⑥ Sleeve Nut (M6x13)  x 4
		⑦ Allen key (M4)  x 2

Sofa Parts

















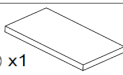

 A x1	 J x1	① Screw (M6x80)  x 4
 B x1	 K x1	② Bolt (M6x45)  x 5
 I x1	 G x2	③ Bolt (M6x60)  x 2
	 L x1	④ Bolt (M6x80)  x 2
		⑤ Caps Nut (M6x18)  x 4
		⑥ Sleeve Nut (M6x13)  x 4
		⑦ Allen key (M4)  x 2

Table Parts

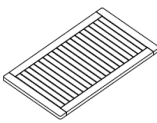
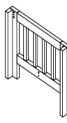
 M x1	 N x2	② Bolt (M6x45)  x 1
	 O x1	③ Bolt (M6x60)  x 6
		⑥ Sleeve Nut (M6x13)  x 6
		⑦ Allen key (M4)  x 1

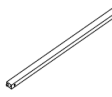
NOTE: The quantities above are the correct amount to complete the assembly. In some cases more fittings may be supplied than are required.

STEP 1

Use a clear, flat, soft surface to avoid bumps or scratches. Lay all your components and fixings out.

Place the table top [M] upside down and insert 4 x sleeve nuts [6] into the pre-drilled holes using 1 x bolt [2].

Insert 2 x sleeve nuts [6] into support bar [O] using 1 x bolt [2].

Align 2 x side panels [N] and support bar [O] with table top [M] and attach using 6 x bolts [3].

Tighten with allen key [7].

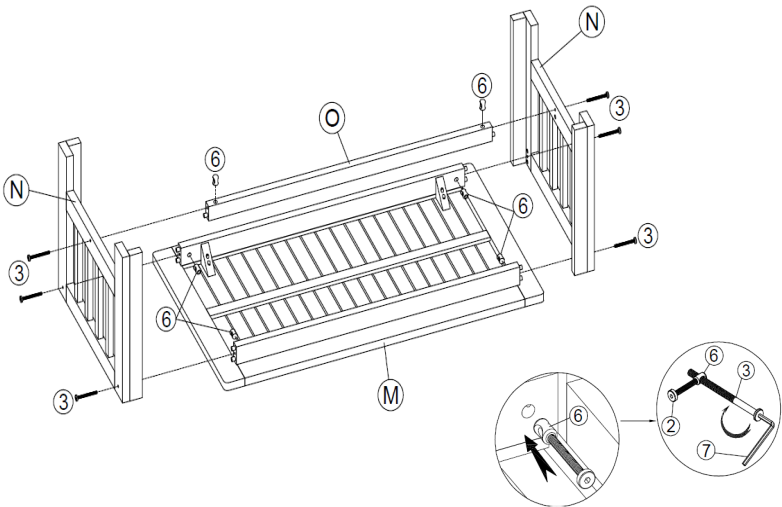

STEP 2

Carefully, and with help, flip your table so it stands on its feet. Check stability. Your table is now ready to use!

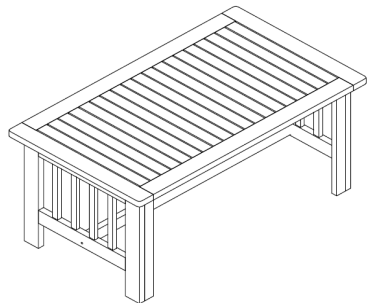

Sofa Assembly

STEP 3

Insert 2 x sleeve nuts [6] into seat panel [J] and support bar [K] using 1 x bolt [2] and align parts [J + K] with the pre-drilled holes on side panel [B].

Attach using 1 x bolt [3] + 1 x bolt [4] and tighten with allen key [7].

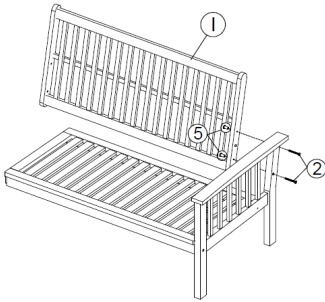
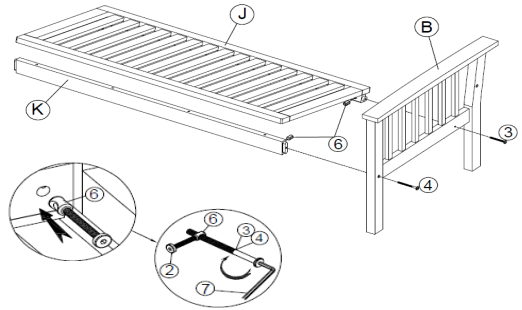

STEP 4

Align back rest [I] with the pre-drilled holes on the side panel [B] and attach using 2 x cap nuts [5] + 2 x bolts [2]. Tighten with 2 x allen keys [7].

STEP 5

Align side panel [A] with the pre-drilled holes on the back rest [I] + seat panel [J].

Attach to seat panel [J] using 2 x sleeve nuts [6] + 1 x bolts [4] + 1 x bolt [3].

Attach to back rest [I] using 2 x cap nuts [5] + 2 x bolts [2].

Tighten with 2 allen keys [7].

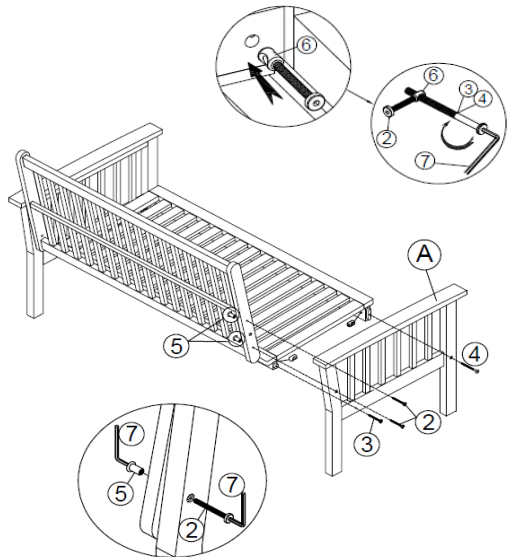

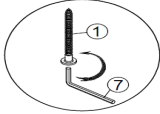
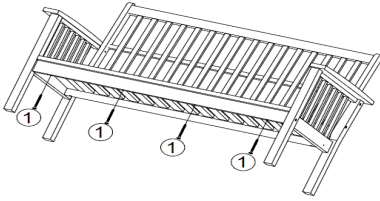

STEP 6

Secure the sofa using 4 x screws [1] and tighten with allen key [7].

STEP 7

Check the stability. Place 1 x seat cushion [L] + 2 x back rest cushions [C] onto the sofa.
Your sofa is now ready to use!

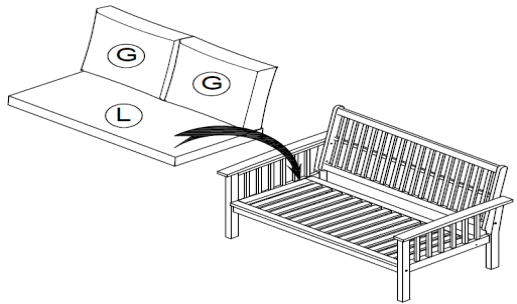

Chair Assembly

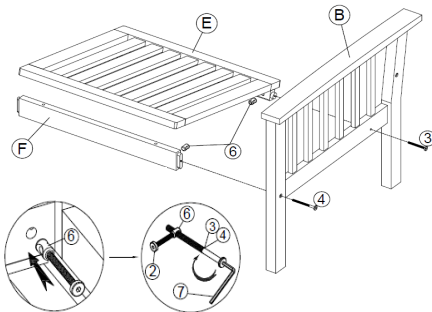

STEP 8

Insert 2 x sleeve nuts [6] into seat panel [E] and support bar [F] using 1 x bolt [2]. Align parts [E + F] with the pre-drilled holes on side panel [B]. Attach using 1 x bolt [3] + 1 x bolt [4] and tighten with allen key [7].

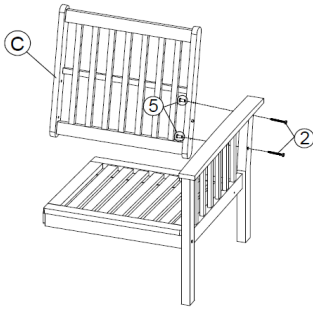

STEP 9

Align back rest [C] with the pre-drilled holes on the side panel [B] and attach using 2 x cap nuts [5] + 2 x bolts [2].

Tighten with 2 x allen keys [7].

STEP 10

Align side panel [A] with the pre-drilled holes on the back rest [C] + seat panel [E].

Attach to seat panel [E] using 2 x sleeve nuts [6] + 1 x bolts [4] + 1 x bolt [3].

Attach to back rest [C] using 2 x cap nuts [5] + 2 x bolts [2].

Tighten with 2 x allen keys [7].

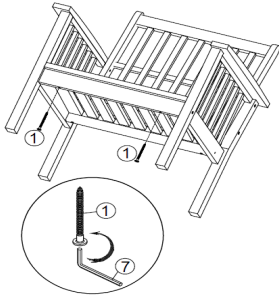
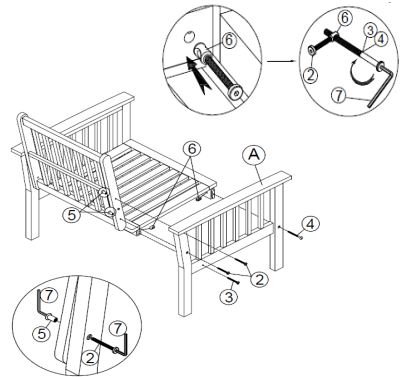

STEP 11

Secure the chair using 2 x screws [1] and tighten with allen key [7].

STEP 12

Check the stability. Place 1 x seat cushion [H] + 1 x back rest cushion [G] onto the chair.

Your chair is now ready to use!

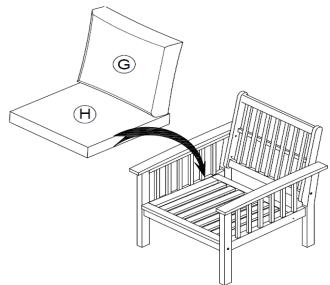



OUR 2 YEAR* GUARANTEE

our products come with a 2 year guarantee to give you peace of mind shopping at

*excludes some garden furniture items which have a 1 year guarantee



WHAT THE GUARANTEE COVERS



PRE-INSERTED FIXINGS
e.g. lose metal threads



FAULTY JOINTS
e.g. legs bending



EXTERNAL FIXING FAULTS
e.g. bonding/glue



STRUCTURAL INTEGRITY
e.g. the frame of the product