

# INSTRUCTION MANUAL

## Foldable Greenhouse

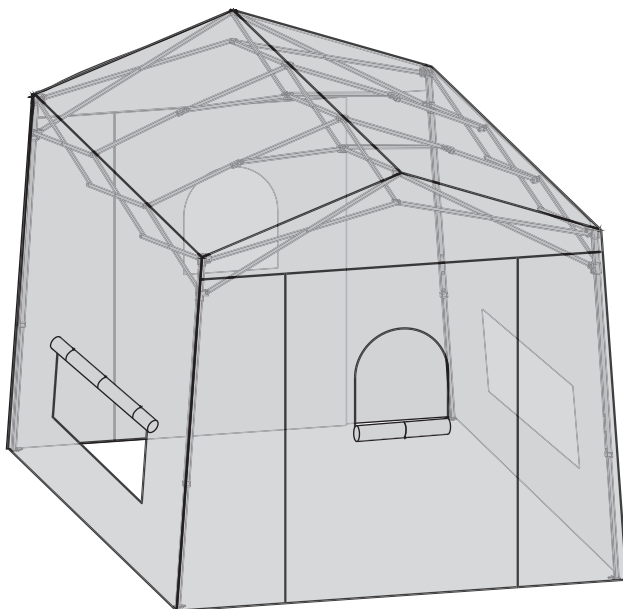

---

Do not return your greenhouse to the place of purchase.  
For warranty service, repair parts, or product questions please  
email: [yardsightfurniture@outlook.com](mailto:yardsightfurniture@outlook.com)



---

## SET UP THE GREENHOUSE

### Step 1 OPEN THE FRAME

- Lift and partially pull the frame apart.

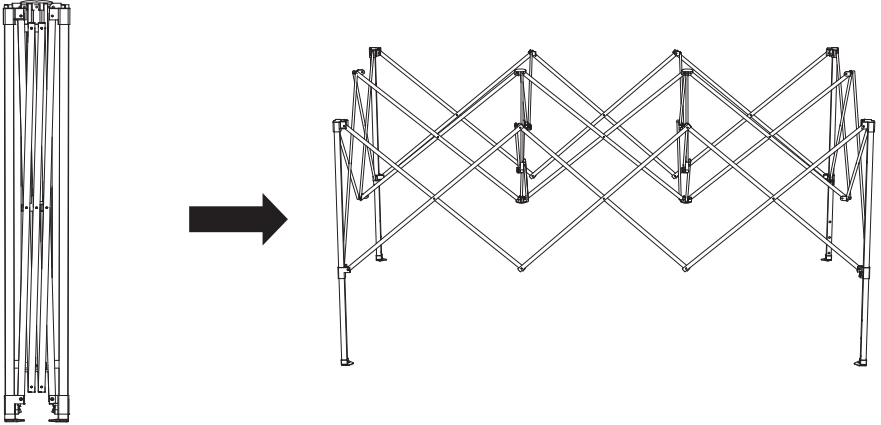

### Step 2 ATTACH THE TOP

- Unfold the top, unzip the door and place on top of the frame. Avoid the peak cap hooking the lining of the top.

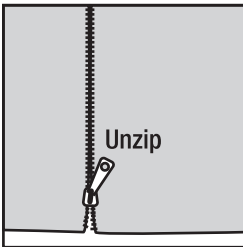

- Secure the top to the corners of the frame using velcro.

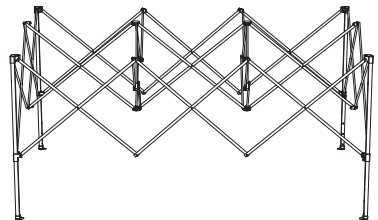
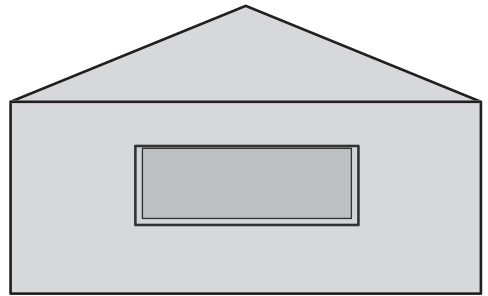
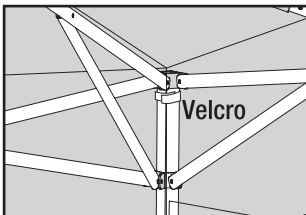

---

## SET UP THE GREENHOUSE

### Step 3 LOCK THE FRAME

- Two persons lift the greenhouse to below push position.  
Lift up the slider until it automatically locked in.

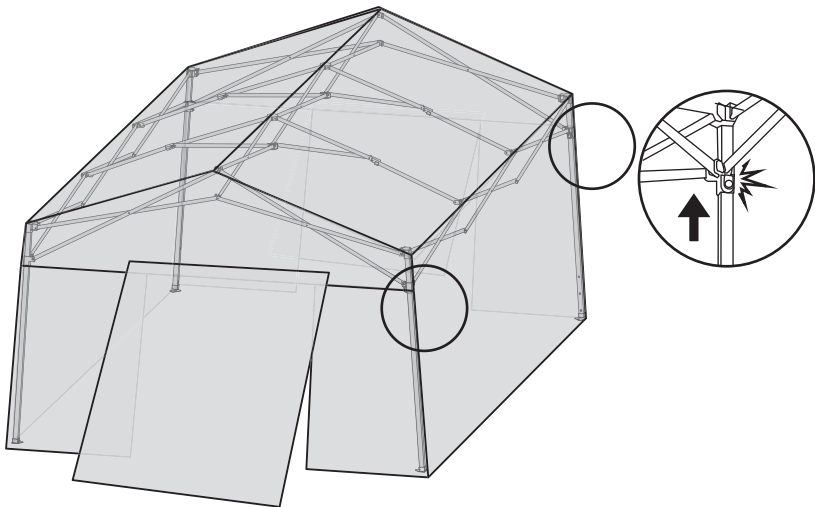
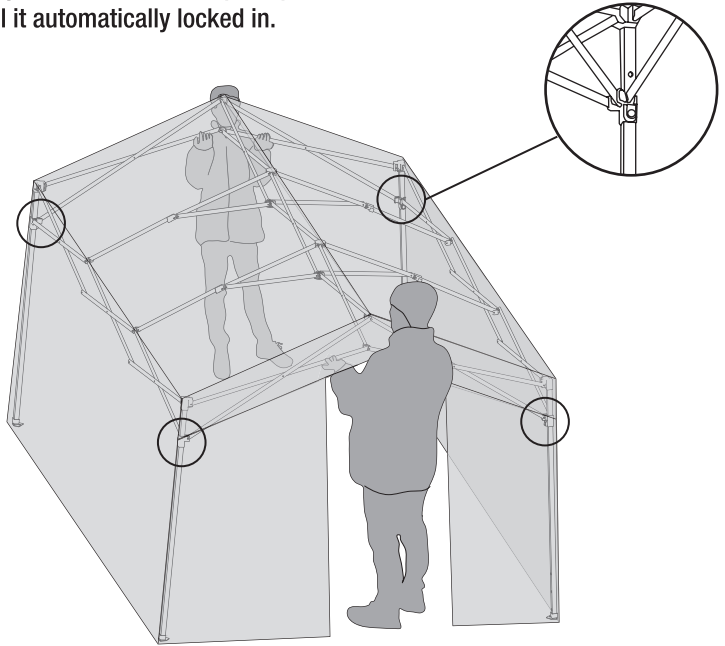

---

## SET UP THE GREENHOUSE

### Step 4 ADJUST THE HEIGHT

- Press the push pin on each leg and raise or lower the bottom leg extension to adjust the height.

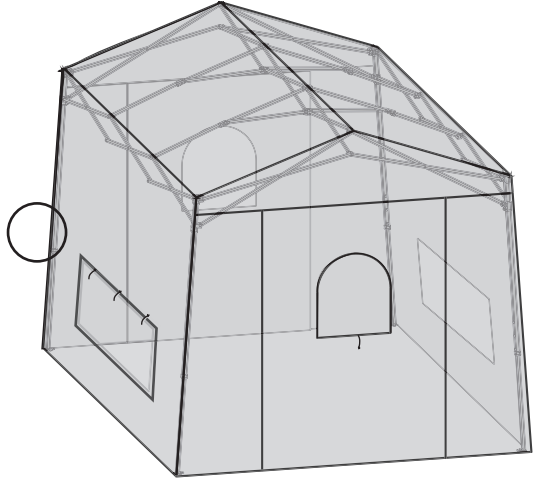
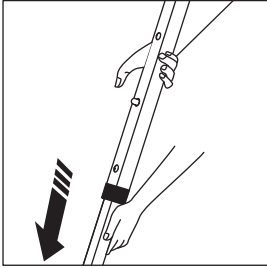

### Step 5 VELCRO CONNECTION

- Secure the top to the legs of the frame using the velcro connections.

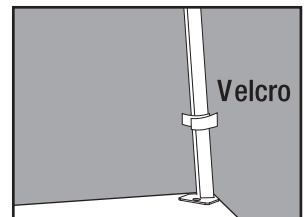
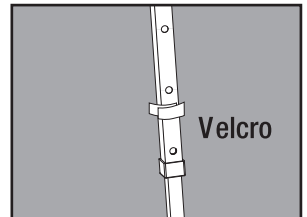
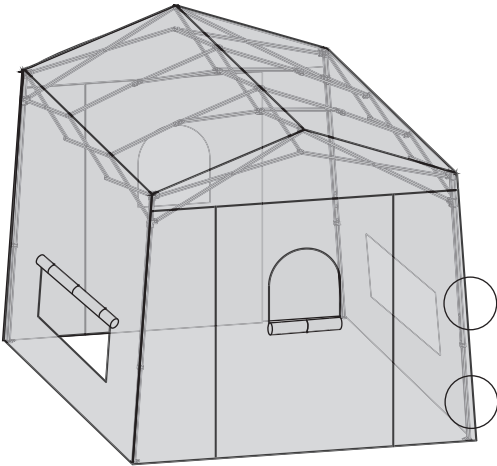

---

## SET UP THE GREENHOUSE

### Step 6 SECURE THE GREENHOUSE IN PLACE

- Unzip the doors and insert a spiral stake into the footpad of each leg.
- Insert stakes into the loops at bottom of sidewall.
- Tie four ropes to the corners of the top fabric. Measure out from the each leg to a proper distance and secure four stakes to the ground. Tie the ropes to the stakes in the ground. Ensure the rope has the proper tension by adjusting the plastic adjusters on the ropes.

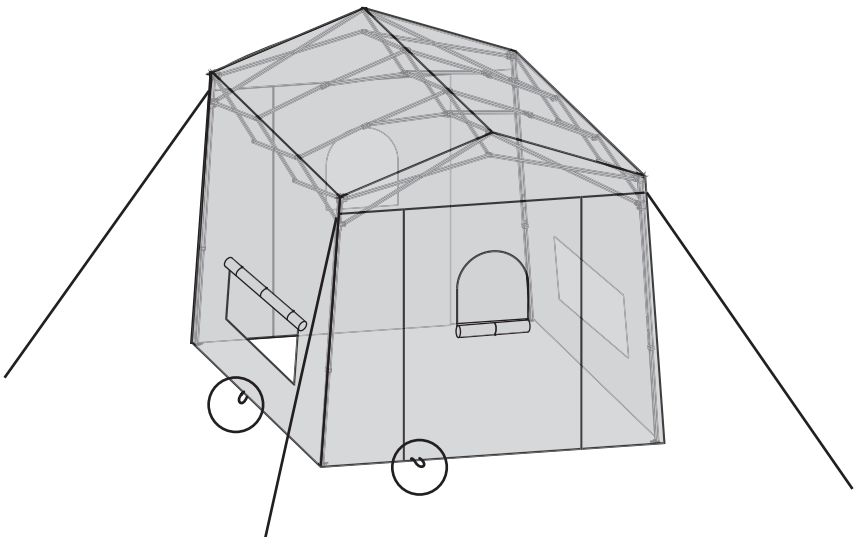
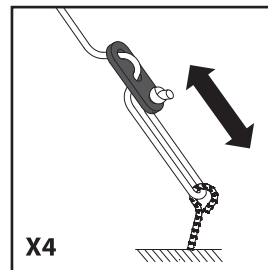
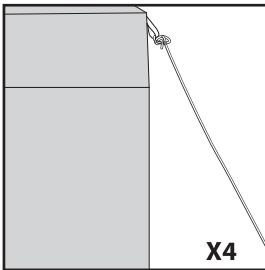
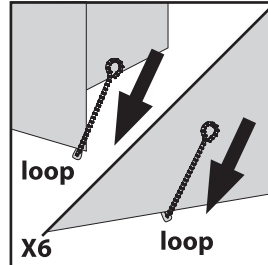
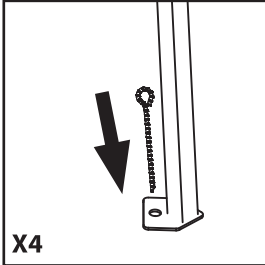

---

## SET UP THE GREENHOUSE

### Step 7 ROLL UP THE DOOR AND THE CURTAIN

- Roll up the doors and the curtains if necessary.

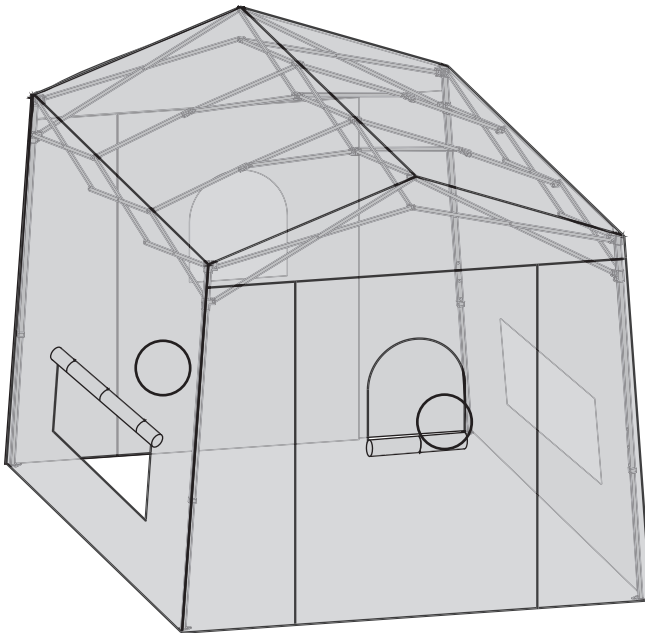
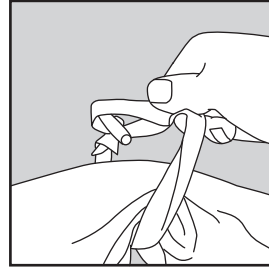

---

## TAKE DOWN THE GREENHOUSE

### Step 8

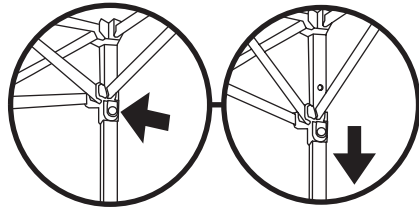
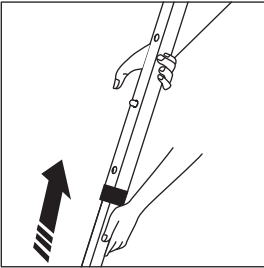
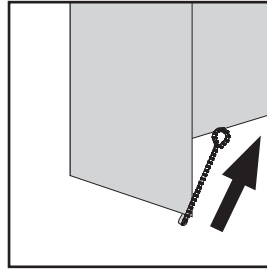
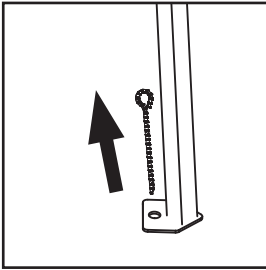

- Pull up all stakes from the ground.
- Press the push pin on each leg and retract the legs to their original height.
- Press the push button on each slider to unlock the frame.
- Take off the PE top, lift one corner of the frame until all legs are raised off the ground except for the 1 leg on the opposite corner. Push inward until the frame is fully closed.

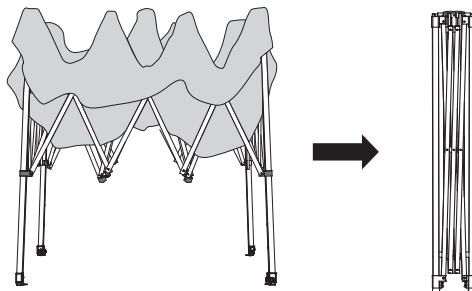

# REPLACEMENT PARTS

## Spare Parts

To inquire about replacement parts, please email to [yardsightfurniture@outlook.com](mailto:yardsightfurniture@outlook.com)

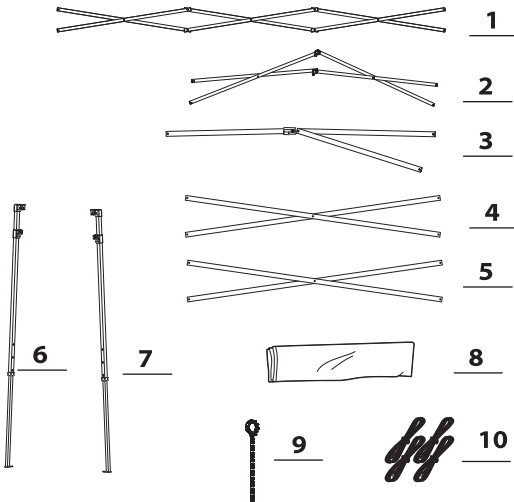
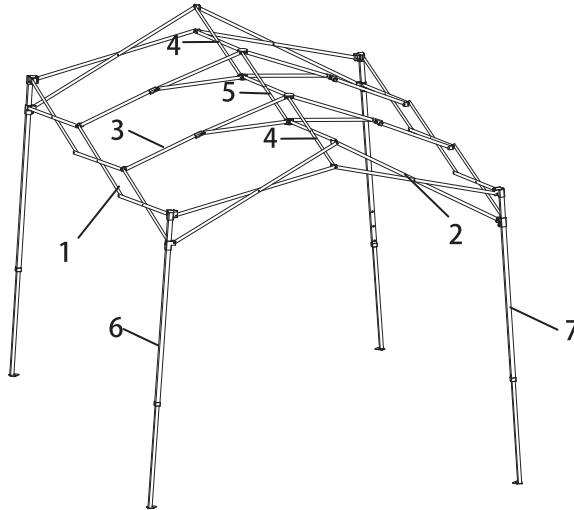

Part	Description
1	Side Eave Assembly
2	Ceiling Assembly
3	Peak Eave Assembly
4	Side Support Assembly
5	Left Leg Assembly
6	Middle Support Assembly
7	Right Leg Assembly
8	PE Top
9	Stake
10	Rope

# MANUEL D'INSTRUCTION

## Serre Pliable

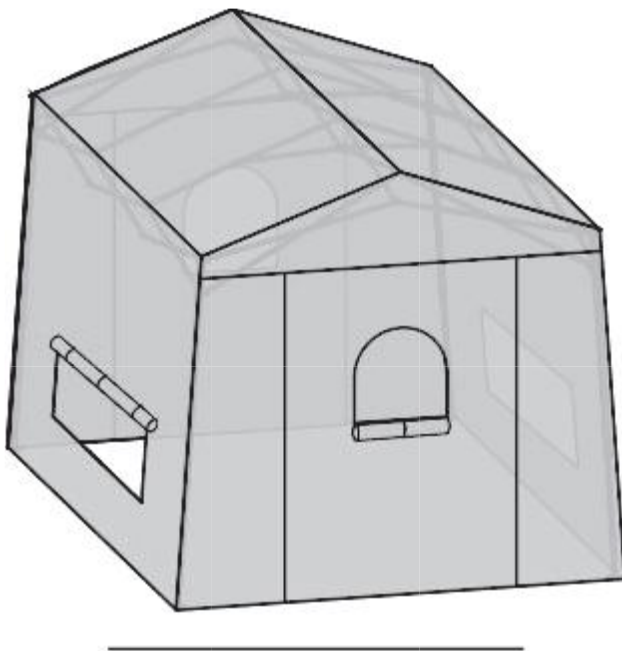

SI VOUS AVEZ ACHETÉ LA SERRE EN LIGNE ET QUE VOUS  
AVEZ DES  
QUESTION OU PRÉOCCUPATION  
VEUILLEZ NOUS CONTACTER PAR COURRIEL  
[yardsightfurniture@outlook.com](mailto:yardsightfurniture@outlook.com)



# INSTALLER LA SERRE

## Étape 1 OUVRIRE LE CADRE

- Soulevez et séparez partiellement le cadre.

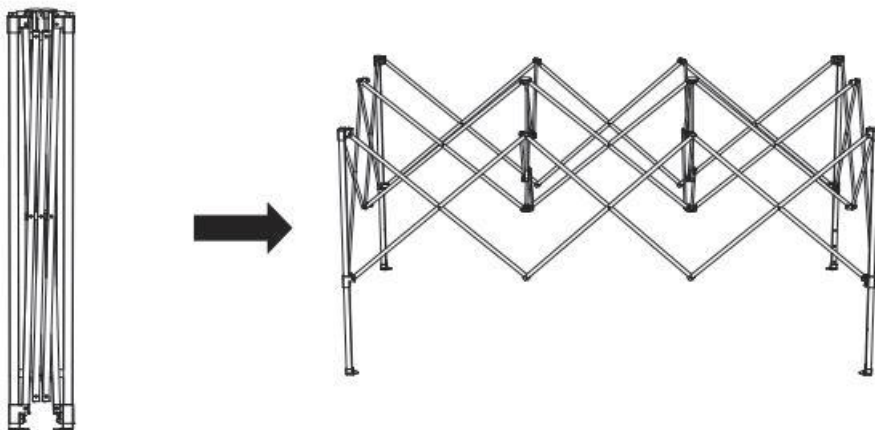

## Étape 2 FIXEZ LE HAUT

- Dépliez le haut, décompressez la porte et placez au-dessus du cadre. Evitez le pic bonnet accrochant la doublure du haut.

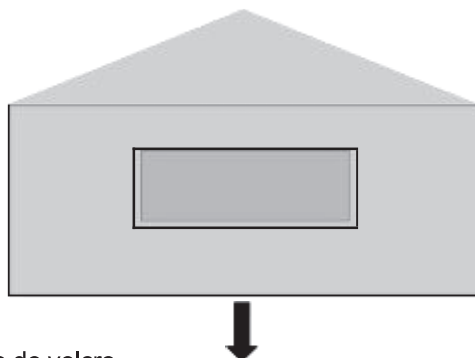
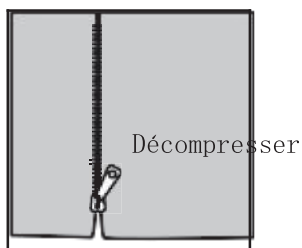

- Fixez le haut aux coins du cadre à l'aide de velcro.

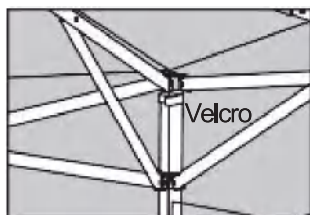

### Étape 3

## VERROUILLEZ LE CADRE

- Deux personnes poussent la serre jusqu'en position de poussée inférieure.

Soulevez le curseur jusqu'à ce qu'il se verrouille automatiquement.

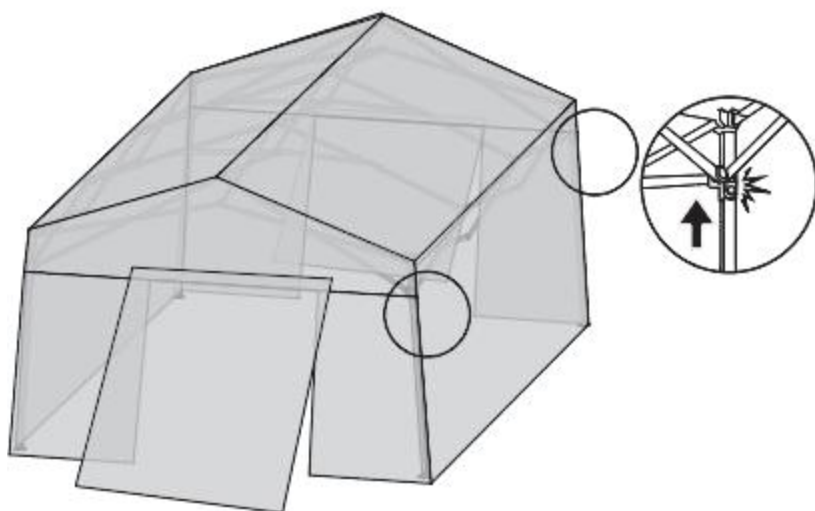
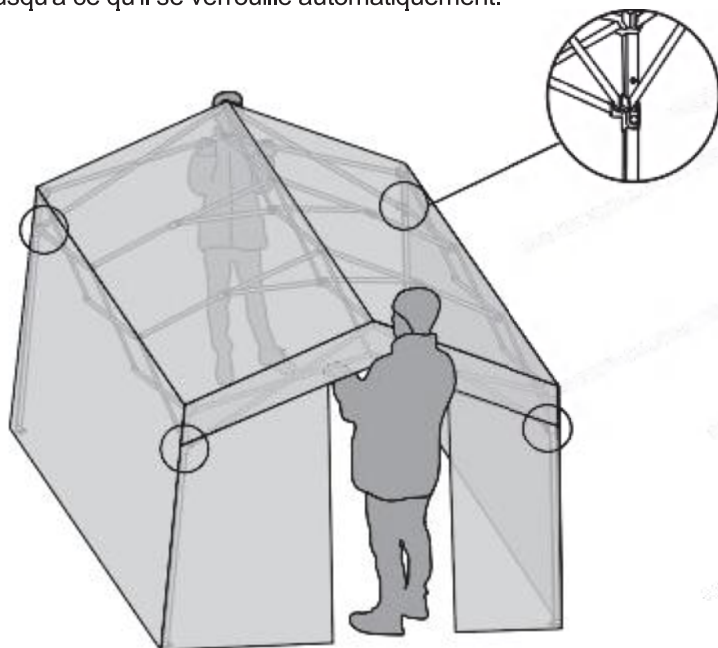

## Étape 4 RÉGLER LA HAUTEUR

- Appuyez sur la punaise de chaque jambe et soulevez ou abaissez l'extension de la jambe inférieure pour régler la hauteur.

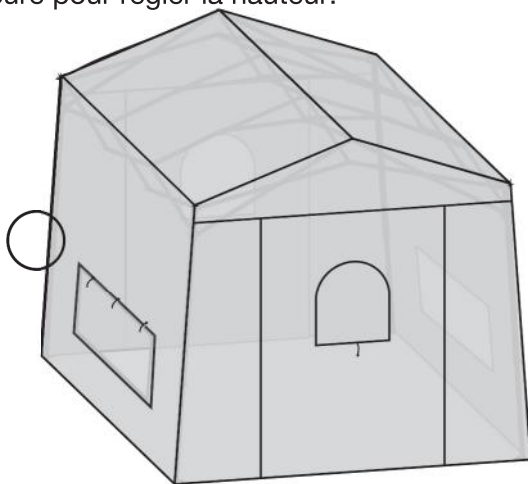
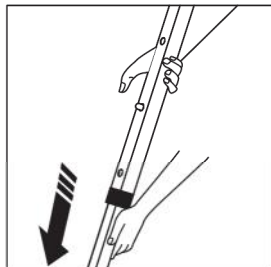

## Étape 5 CONNEXION VELCRO

- Fixez le haut aux pieds du cadre à l'aide des connexions velcro.

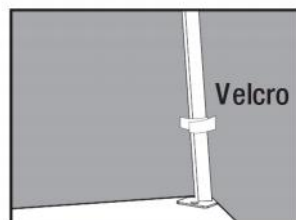
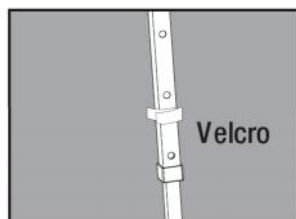
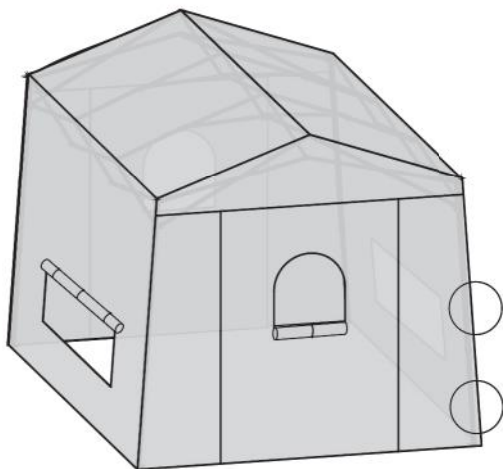

## Étape 6

## FIXEZ LA SERRE EN PLACE

- Décompressez les portes et insérez un piquet en spirale dans le repose-pieds de chaque jambe.
- Insérez les piquets dans les boucles au bas de la paroi latérale.
- Attachez quatre cordes aux coins du tissu supérieur. Mesurez à partir de chaque jambe à une distance appropriée et fixez quatre piquets au sol. Attachez les cordes aux piquets dans le sol. Assurez-vous que la corde a la bonne tension en ajustant les ajusteurs en plastique sur les cordes.

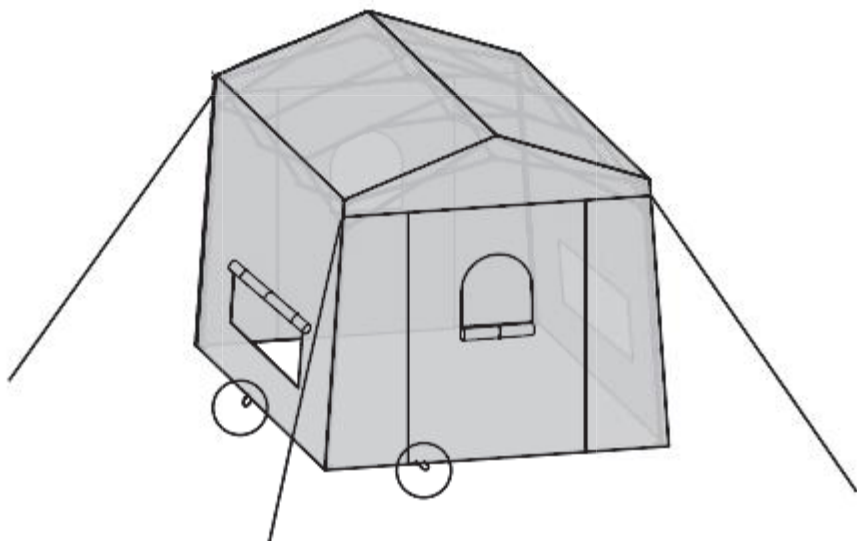
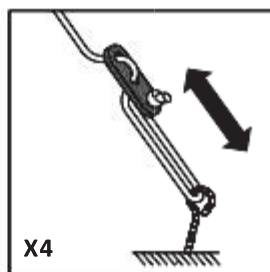
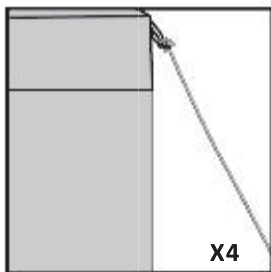
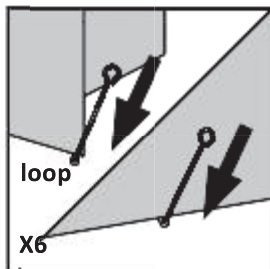
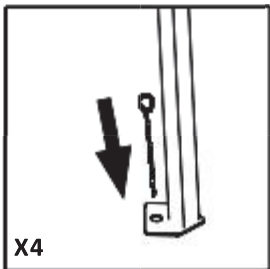

---

## Étape 7 ENROULER LA PORTE ET LE RIDEAU

- Roulez les portes et les rideaux si nécessaire

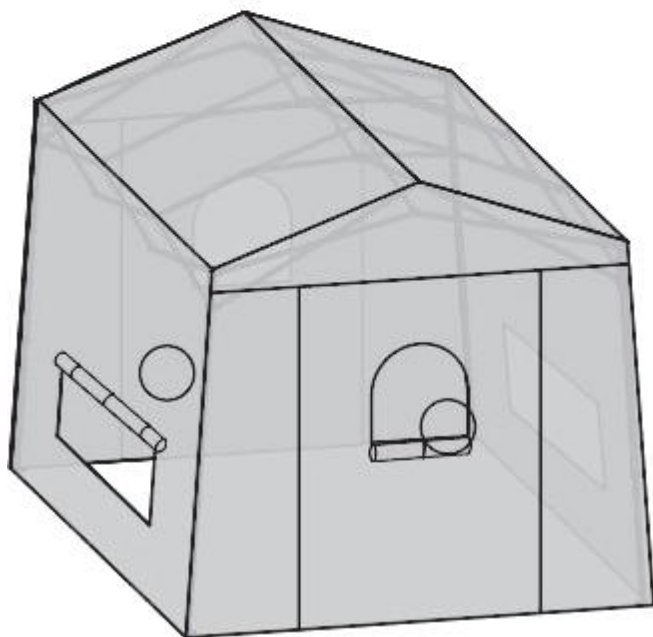
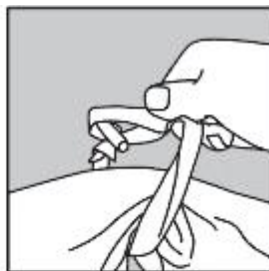

---

## DEMONTER LA SERRE

### Étape 8

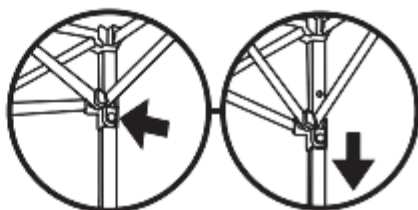
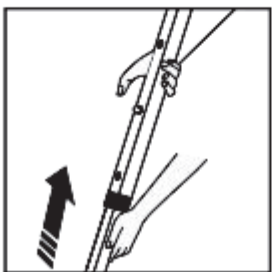
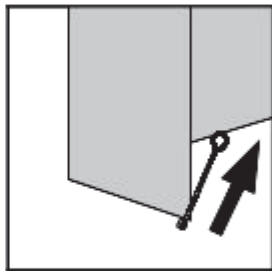
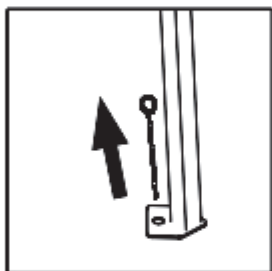

- Retirez tous les piquets du sol
- Appuyez sur la punaise de chaque pied et rétractez les pieds à leur hauteur d'origine.
- Appuyez sur le bouton poussoir de chaque curseur pour déverrouiller le cadre.
- Enlevez le dessus en PE, soulevez un coin du cadre jusqu'à ce que tous les pieds soient soulevés du sol à l'exception du pied 1 sur le coin opposé. Poussez vers l'intérieur jusqu'à ce que le cadre soit complètement fermé

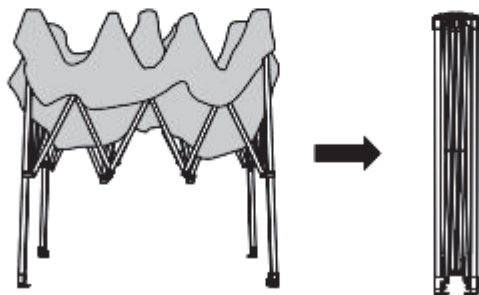

## PIÈCES DE RECHANGE

### Pièces de rechange

Pour vous renseigner sur les pièces de rechange, veuillez envoyer un courriel à [yardsightfurniture@outlook.com](mailto:yardsightfurniture@outlook.com)

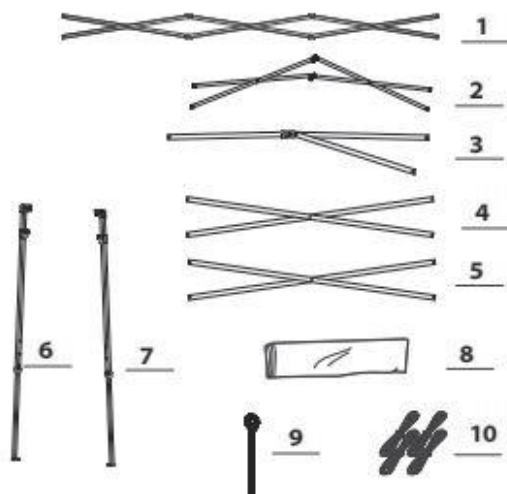
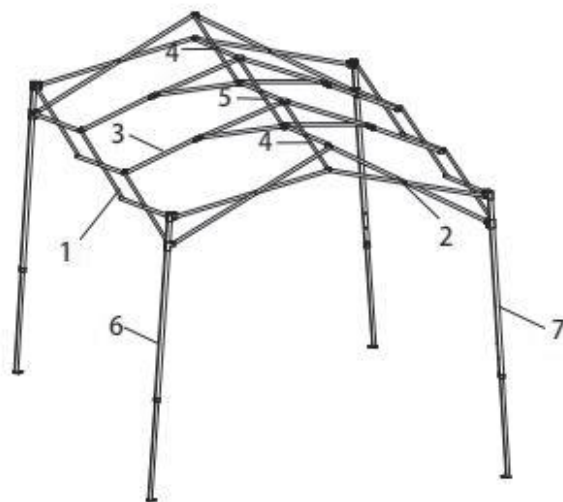

PARTIE	La description
1	Assemblage de l'avant-toit latéral
2	Assemblage de plafond
3	Assemblage d'avant-toit de pointe
4	Ensemble de support latéral
5	Assemblage de la jambe gauche
6	Assemblage du support intermédiaire
7	Assemblage de la jambe droite
8	Haut PE
9	Miser
10	Corde