

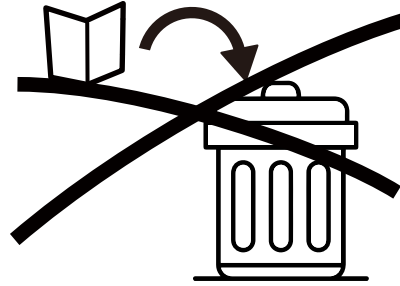

ASSEMBLY INSTRUCTIONS

NOTICE

IMPORTANT, RETAIN FOR FUTURE REFERENCE: READ CAREFULLY
WICHTIG, FÜR SPÄTERE NACHSCHLAGE AUFBEWAHREN: SORGFÄLTIG LESEN
IMPORTANTE, GUARDAR PARA REFERENCIA POSTERIOR: LEER ATENTAMENTE
IMPORTANTE, CONSERVARE PER RIFERIMENTI FUTURI: LEGGERE ATTENTAMENTE
IMPORTANT, À CONSERVER POUR RÉFÉRENCE FUTURE : LIRE ATTENTIVEMENT

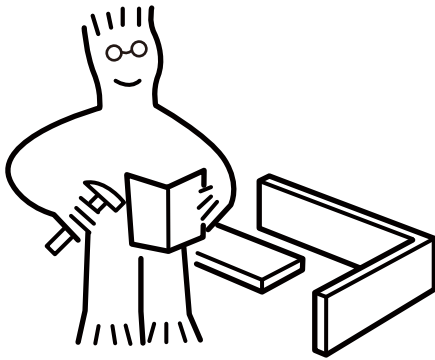

Assemble on a flat, clean and soft surface.
Auf einer flachen, sauberen und weichen Oberfläche zusammenbauen.
Assembler sur une surface plate, propre et douce.
Assemblare su una superficie piatta, pulita e morbida.
Ensamblar sobre una superficie plana, limpia y suave.

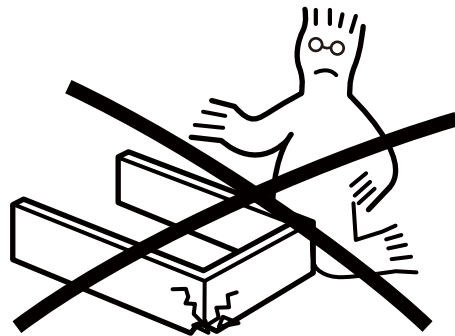
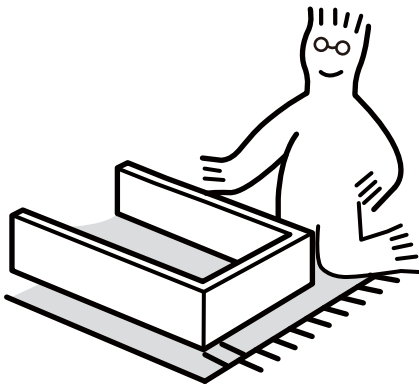

Professional installation is highly recommended.
Eine professionelle Installation wird dringend empfohlen.
Une installation professionnelle est fortement recommandée.
Si raccomanda vivamente l'installazione professionale.
Se recomienda altamente la instalación profesional.



Periodically Check That All Components Are Tightly Secured.
Überprüfen Sie Regelmäßig, Dass Alle Komponenten Fest Gesichert Sind.
Vérifiez Périodiquement Que Tous Les Composants Sont Bien Fixés.
Controllare Periodicamente Che Tutti I Componenti Siano Ben Fissati.
Verifique Periódicamente Que Todos Los Componentes Estén Bien Asegurados.

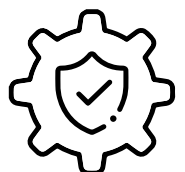

It is recommended that multiple people assemble this product.

Es wird empfohlen, dass mehrere Personen dieses Produkt zusammenbauen.

Il est recommandé que plusieurs personnes assemblent ce produit.

Si raccomanda che più persone assemblino questo prodotto.

Se recomienda que varias personas ensamblen este producto.

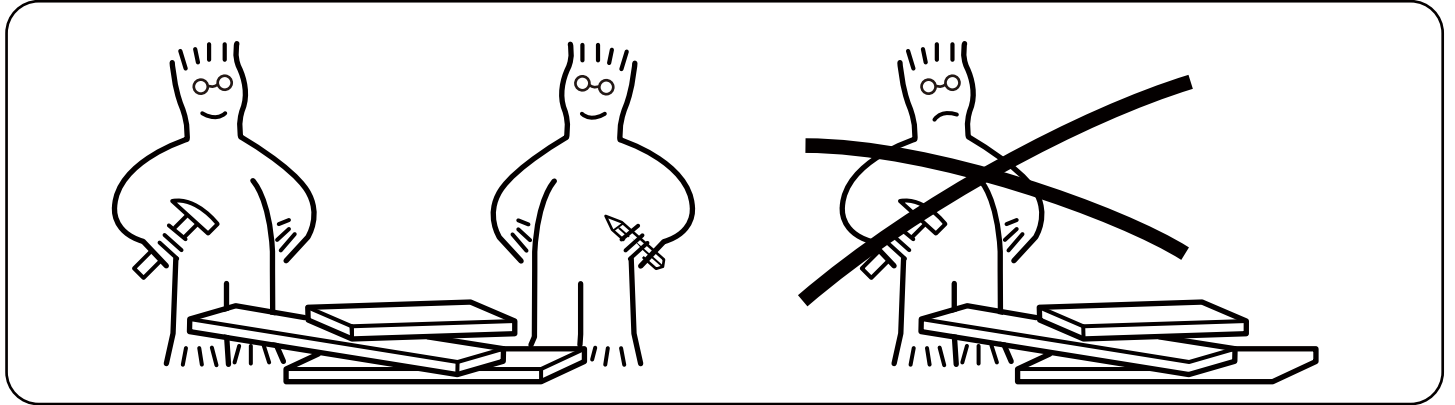

USING CAM LOCK AND QUICKFIT
VERWENDUNG VON NOCKENSCHLOSS UND QUICKFIT
UTILISATION DE SERRURE À CAME ET QUICKFIT
USO DI SERRATURA A LEVA E QUICKFIT
USANDO EL CIERRE DE LEVA Y QUICKFIT

Tighten QuickFit until the shoulder is flush with the panel. Do not overtighten or undertighten.
Ziehen Sie den Quickfit an, bis die Schulter bündig mit der Platte ist. Nicht zu fest oder zu locker anziehen.

Serrez le quickfit jusqu'à ce que l'épaulement soit affleurant avec le panneau. Ne serrez pas trop ou trop peu.

Stringere il quickfit fino a quando la spalla è a filo con il pannello. Non stringere troppo o troppo poco.
Apriete el quickfit hasta que el hombro esté al ras con el panel. No apriete demasiado ni demasiado poco.

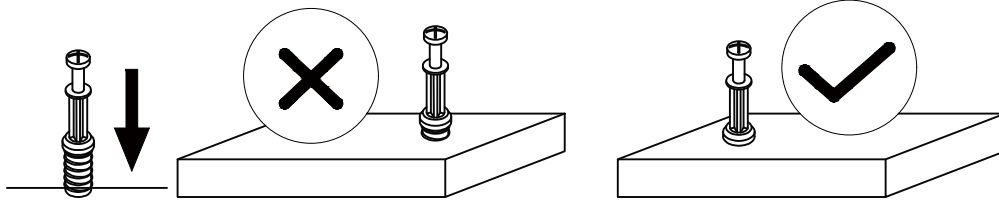

When fitting the cam lock, ensure the starting position is correct before inserting the connecting QuickFit.

Stellen Sie beim Einbau des nockenschloss sicher, dass die Startposition korrekt ist, bevor Sie den verbindenden Quickfit einsetzen.

Lors de la pose du serrure à came, assurez-vous que la position de départ est correcte avant d'insérer le quickfit de connexion.

Quando si monta il serratura a leva, assicurarsi che la posizione di partenza sia corretta prima di inserire il quickfit di collegamento.

Al instalar el cierre de leva, asegúrese de que la posición inicial sea correcta antes de insertar el quickfit de conexión.

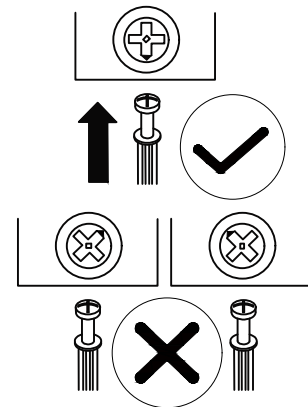

The QuickFit head should be in the center of the cam lock when the two panels are joined. The cam lock should be inserted before the QuickFit. Turn the cam lock clockwise to tighten.

Der Quickfit-Kopf sollte sich in der Mitte des nockenschloss befinden, wenn die beiden Platten verbunden sind. Der nockenschloss sollte vor dem Quickfit eingesetzt werden. Drehen Sie den nockenschloss im Uhrzeigersinn, um ihn zu befestigen.

La tête du quickfit doit être au centre du serrure à came lorsque les deux panneaux sont assemblés. Le serrure à came doit être inséré avant le quickfit. Tournez le serrure à came dans le sens des aiguilles d'une montre pour le serrer.

La testa del quickfit dovrebbe essere al centro del serratura a leva quando i due pannelli sono uniti. Il serratura a leva deve essere inserito prima del quickfit. Ruotare il serratura a leva in senso orario per stringere.

La cabeza del quickfit debe estar en el centro del cam lock cuando los dos paneles estén unidos. El cierre de leva debe insertarse antes del quickfit. Gire el cierre de leva en sentido horario para apretar.

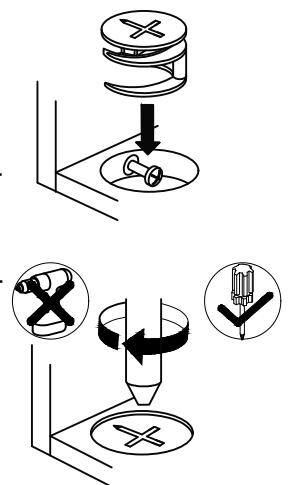



WARNING

Battery Safety Warning

- This product may or may not contain a button cell or coin battery depending on the model configuration.

INGESTION HAZARD

- Death or serious injury can occur if swallowed. A swallowed button or coin cell battery can cause **Internal Chemical Burns** in as little as **2 hours**.
- **KEEP** new and used batteries **OUT OF REACH of CHILDREN**.
- Seek immediate medical attention if a battery is suspected to have been swallowed or inserted inside any part of the body.

Battery Use and Handling

- Use only compatible battery types (e.g., LR44, CR2032) with the correct nominal voltage.
- Install batteries according to correct polarity (+/-).
- Do not mix old and new batteries, different brands, or different types (e.g., alkaline, carbon-zinc, or rechargeable).
- Remove batteries from devices not used for extended periods.
- Recycle or dispose of used batteries properly, following local regulations. Do NOT throw into household trash or incinerate.
- Do NOT recharge non-rechargeable batteries.
- Do NOT force discharge, disassemble, heat above the manufacturer's recommended temperature, or incinerate. This may cause leakage, explosion, or chemical burns.

Battery Compartment Safety

- Always ensure the battery compartment is completely secured.
- If the compartment does not close properly, stop using the product. Remove the batteries and keep them away from children.



WARNING

Batteriesicherheitswarnung

- Dieses Produkt kann je nach Modellkonfiguration eine Knopfzelle oder Münzbatterie enthalten oder nicht enthalten.

GEFAHR BEI VERSCHLUCKEN

- Der Tod oder schwere Verletzungen können die Folge sein, wenn eine Batterie verschluckt wird. Eine verschluckte Knopfzelle oder Münzbatterie kann innerhalb von nur 2 Stunden zu inneren chemischen Verätzungen führen.
- BEWAHREN SIE neue und gebrauchte Batterien AUSSERHALB DER REICHWEITE VON KINDERN auf.
- Suchen Sie sofort ärztliche Hilfe, wenn der Verdacht besteht, dass eine Batterie verschluckt oder in einen Körperteil eingeführt wurde.

Verwendung und Handhabung von Batterien

- Verwenden Sie nur kompatible Batterietypen (z.B. LR44, CR2032) mit der korrekten Nennspannung.
- Achten Sie beim Einlegen auf die korrekte Polarität (+/-).
- Mischen Sie keine alten und neuen Batterien, keine unterschiedlichen Marken oder Typen (z.B. Alkali, Zink-Kohle, wiederaufladbare Batterien).
- Entfernen Sie Batterien aus Geräten, die längere Zeit nicht verwendet werden.
- Recyceln oder entsorgen Sie gebrauchte Batterien gemäß den örtlichen Vorschriften. Werfen Sie Batterien NICHT in den Hausmüll oder ins Feuer.
- Laden Sie nicht wiederaufladbare Batterien NICHT auf.
- Entladen, zerlegen, erhitzen oder verbrennen Sie Batterien NICHT. Dies kann zu Auslaufen, Explosionen oder chemischen Verbrennungen führen.

Sicherheit des Batteriefachs

- Stellen Sie sicher, dass das Batteriefach vollständig und sicher verschlossen ist.
- Wenn das Fach nicht sicher schließt, stellen Sie die Verwendung des Produkts ein, entfernen Sie die Batterien, und bewahren Sie sie außerhalb der Reichweite von Kindern auf.





AVERTISSEMENT

Avvertissement de sécurité concernant les piles

- Ce produit peut contenir ou non une pile bouton ou une pile plate, selon la configuration du modèle.

RISQUE D'INGESTION

- La mort ou des blessures graves peuvent survenir en cas d'ingestion. Une pile bouton ou une pile plate avalée peut provoquer des brûlures chimiques internes en seulement 2 heures.
- **GARDER les piles neuves et usagées HORS DE PORTÉE DES ENFANTS.**
- En cas d'ingestion ou d'insertion soupçonnée dans une partie du corps, consultez immédiatement un centre antipoison ou un médecin.

Utilisation et manipulation des piles

- Utilisez uniquement des types de piles compatibles (par ex. : LR44, CR2032) avec la tension nominale correcte.
- Installez les piles en respectant la polarité correcte (+/-).
- Ne mélangez pas des piles neuves et usagées, de marques différentes ou de types différents (par ex. : alcaline, carbone-zinc, ou rechargeable).
- Retirez les piles des appareils inutilisés pendant une période prolongée.
- Recyclez ou éliminez les piles usagées conformément aux réglementations locales. Ne pas jeter à la poubelle ni incinérer.
- Ne rechargez PAS les piles non rechargeables.
- Ne forcez PAS la décharge, ne démontez PAS, ne chauffez PAS au-dessus de la température recommandée par le fabricant, et n'incinerez PAS. Cela peut provoquer des fuites, des explosions ou des brûlures chimiques.

Sécurité du compartiment à piles

- Assurez-vous toujours que le compartiment à piles est correctement fermé.
- Si le compartiment ne se ferme pas correctement, cessez d'utiliser le produit. Retirez les piles et gardez-les hors de portée des enfants.

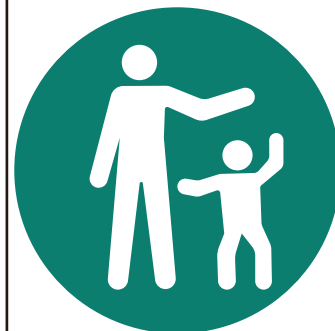

AVVERTENZA

Avvertenze sulla Sicurezza della Batteria

- Questo prodotto può contenere o meno una batteria a bottone o a moneta, a seconda della configurazione del modello.

PERICOLO DI INGESTIONE

- La morte o gravi lesioni possono verificarsi in caso di ingestione. Una batteria a bottone o a moneta ingerita può causare ustioni chimiche interne in appena 2 ore.
- **TENERE le batterie nuove e usate FUORI DALLA PORTATA DEI BAMBINI.**
- In caso di sospetta ingestione o inserimento della batteria in qualsiasi parte del corpo, consultare immediatamente un medico.

Uso e Maneggio delle Batterie

- Utilizzare solo batterie compatibili (es. LR44, CR2032) con la corretta tensione nominale.
- Installare le batterie rispettando la polarità corretta (+/-).
- Non mescolare batterie vecchie e nuove, marche diverse o tipi diversi (es. alcaline, zinco-carbone o ricaricabili).
- Rimuovere le batterie dai dispositivi non utilizzati per lunghi periodi.
- Riciclare o smaltire correttamente le batterie usate secondo le normative locali. NON gettarle nei rifiuti domestici né incenerirle.
- NON ricaricare batterie non ricaricabili.
- NON forzare la scarica, smontare, surriscaldare oltre la temperatura raccomandata dal produttore, o incenerire. Questo potrebbe causare perdite, esplosioni o ustioni chimiche.

Sicurezza del Vano Batterie

- Assicurarsi sempre che il vano batterie sia chiuso correttamente.
- Se il vano non si chiude in modo sicuro, smettere di utilizzare il prodotto, rimuovere le batterie e tenerle lontano dai bambini.

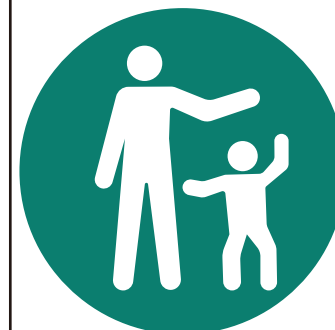



ADVERTENCIA

Advertencia de Seguridad de la Batería

- Este producto puede contener o no una batería tipo botón o moneda, dependiendo de la configuración del modelo.

PELIGRO DE INGESTA

- La ingestión puede causar la muerte o lesiones graves. Una batería tipo botón o moneda ingerida puede causar quemaduras químicas internas en tan solo 2 horas.
- **MANTENGA** las baterías nuevas y usadas **FUERA DEL ALCANCE DE LOS NIÑOS**.
- Busque atención médica inmediata si se sospecha que una batería fue ingerida o insertada en cualquier parte del cuerpo.

Uso y Manejo de la Batería





- Utilice solo tipos de batería compatibles (por ejemplo, LR44, CR2032) con el voltaje nominal correcto.
- Instale las baterías respetando la polaridad correcta (+/-).
- No mezcle baterías viejas y nuevas, ni diferentes marcas o tipos (por ejemplo, alcalinas, zinc-carbono o recargables).
- Retire las baterías de los dispositivos que no se usen durante períodos prolongados.
- Recicle o deseche las baterías usadas de manera adecuada, conforme a las normativas locales. NO las tire a la basura doméstica ni las incinere.
- NO recargue baterías que no sean recargables.
- NO descargue por la fuerza, desmonte, caliente por encima de la temperatura recomendada por el fabricante ni incinere. Esto puede provocar fugas, explosiones o quemaduras químicas.

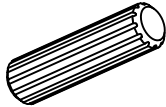
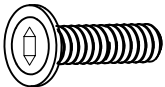
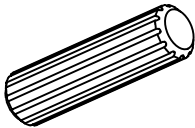
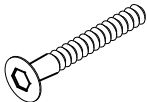
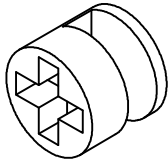

Seguridad del Compartimento de la Batería

- Asegúrese siempre de que el compartimento de la batería esté completamente cerrado.
- Si el compartimento no se cierra correctamente, deje de usar el producto. Retire las baterías y manténgalas fuera del alcance de los niños.

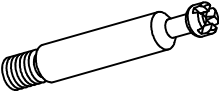

PARTS

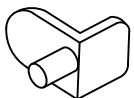
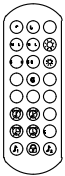
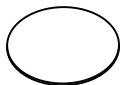
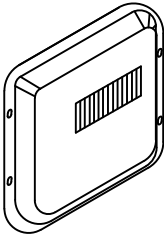
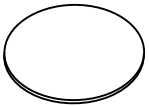
Item no. Nr N °d article Articolo No. Artículo No	Reference Image Referenzbild Image de référence Immagine di riferimento Imagen de referencia	Qty Menge Qté. Qtà Cant.	Item no. Nr N °d article Articolo No. Artículo No	Reference Image Referenzbild Image de référence Immagine di riferimento Imagen de referencia	Qty Menge Qté. Qtà Cant.
(A)	 Ø8 X 30mm	X30	(E)	 M6X18mm	X36
(B)	 Ø10 X 40mm	X8	(F)	 ST5 X 40mm	X2
(C)	 Ø15 X 10mm	X24	(G)	 Ø38 X 60X70X70X2mm	X5
(D)	 35mm	X24	(H)	 70 X 70X2mm	X4

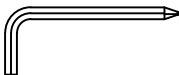
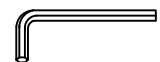
Item no. Nr N °d article Articolo No. Artículo No	Reference Image Referenzbild Image de référence Immagine di riferimento Imagen de referencia	Qty Menge Qté. Qtà Cant.	Item no. Nr N °d article Articolo No. Artículo No	Reference Image Referenzbild Image de référence Immagine di riferimento Imagen de referencia	Qty Menge Qté. Qtà Cant.
I		X8	M		X1
J	 Ø20	X24	N		X1
K	 Ø25X2	X5	O	 ST3.5 X 12mm	X4
L		X1	P	S4  S3 	X1

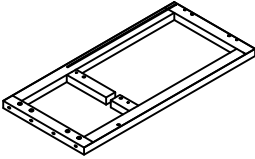
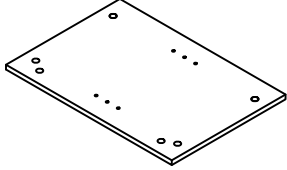
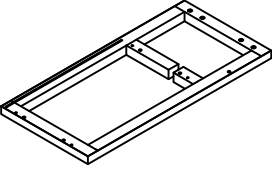
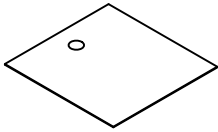
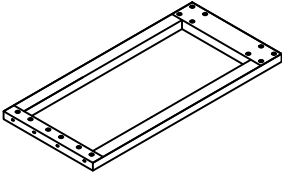
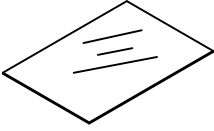
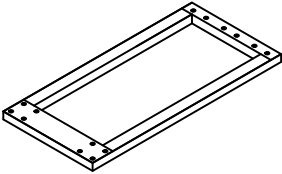
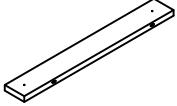
Item no. Nr N °d article Articolo No. Artículo No	Reference Image Referenzbild Image de référence Immagine di riferimento Imagen de referencia	Qty Menge Qté. Qtà Cant.	Item no. Nr N °d article Articolo No. Artículo No	Reference Image Referenzbild Image de référence Immagine di riferimento Imagen de referencia	Qty Menge Qté. Qtà Cant.
1		X1	5		X4
2		X1	6		X2
3		X1	7		X2
4		X1	8		X1

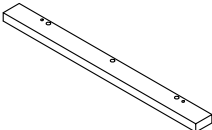
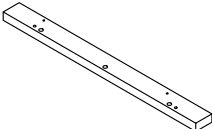
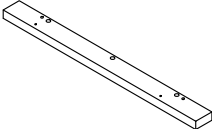
Item no. Nr . N °d article Articolo No. Artículo No	Reference Image Referenzbild Image de référence Immagine di riferimento Imagen de referencia	Qty Menge Qté. Qtà Cant.
9		X2
10		X1
11		X1

EXPLODED VIEW

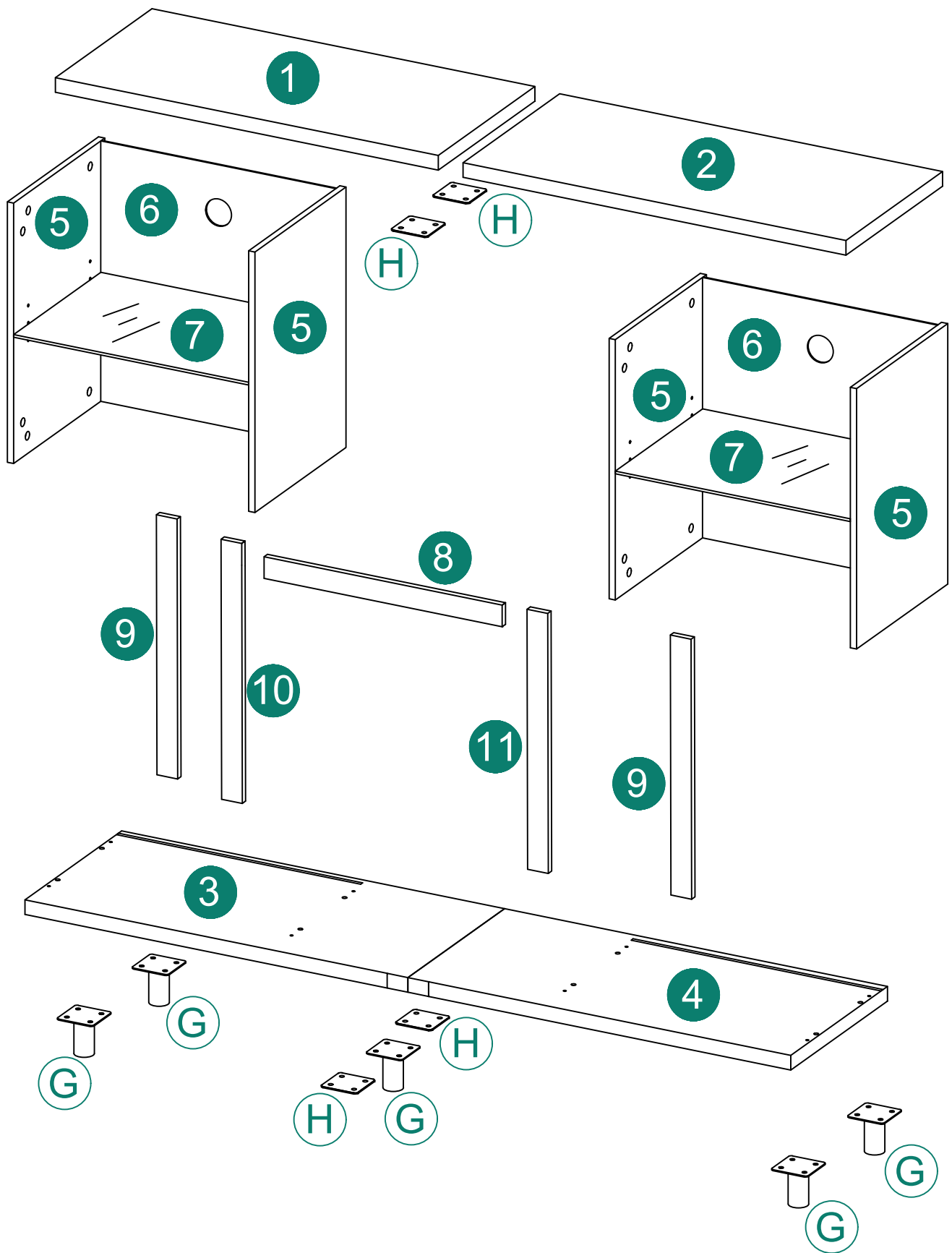

ASSEMBLY

1

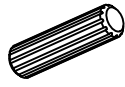

ⓑ X4

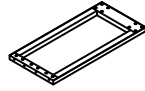

③ X1

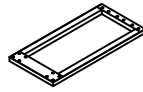

④ X1

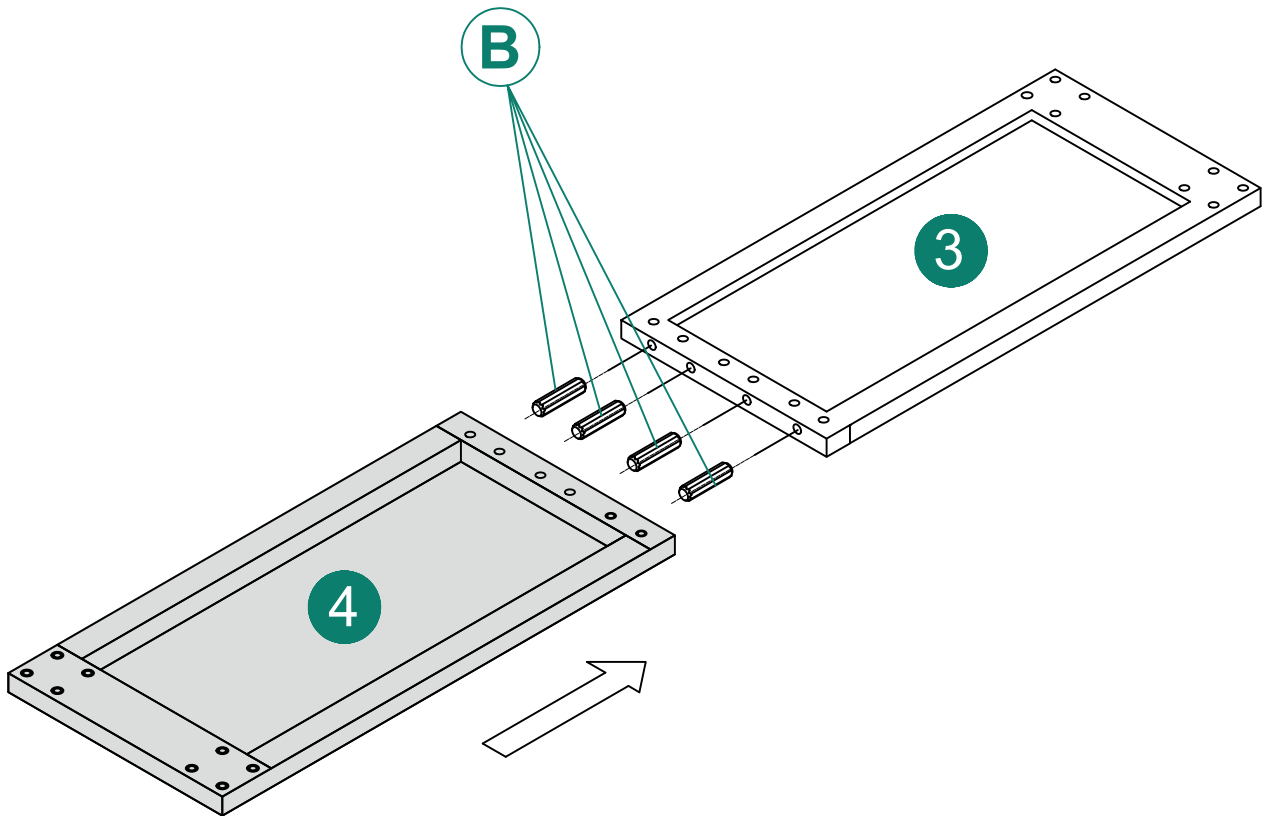

3

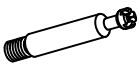
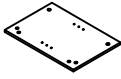
-  (A) X8
-  (D) X8
-  (5) X4

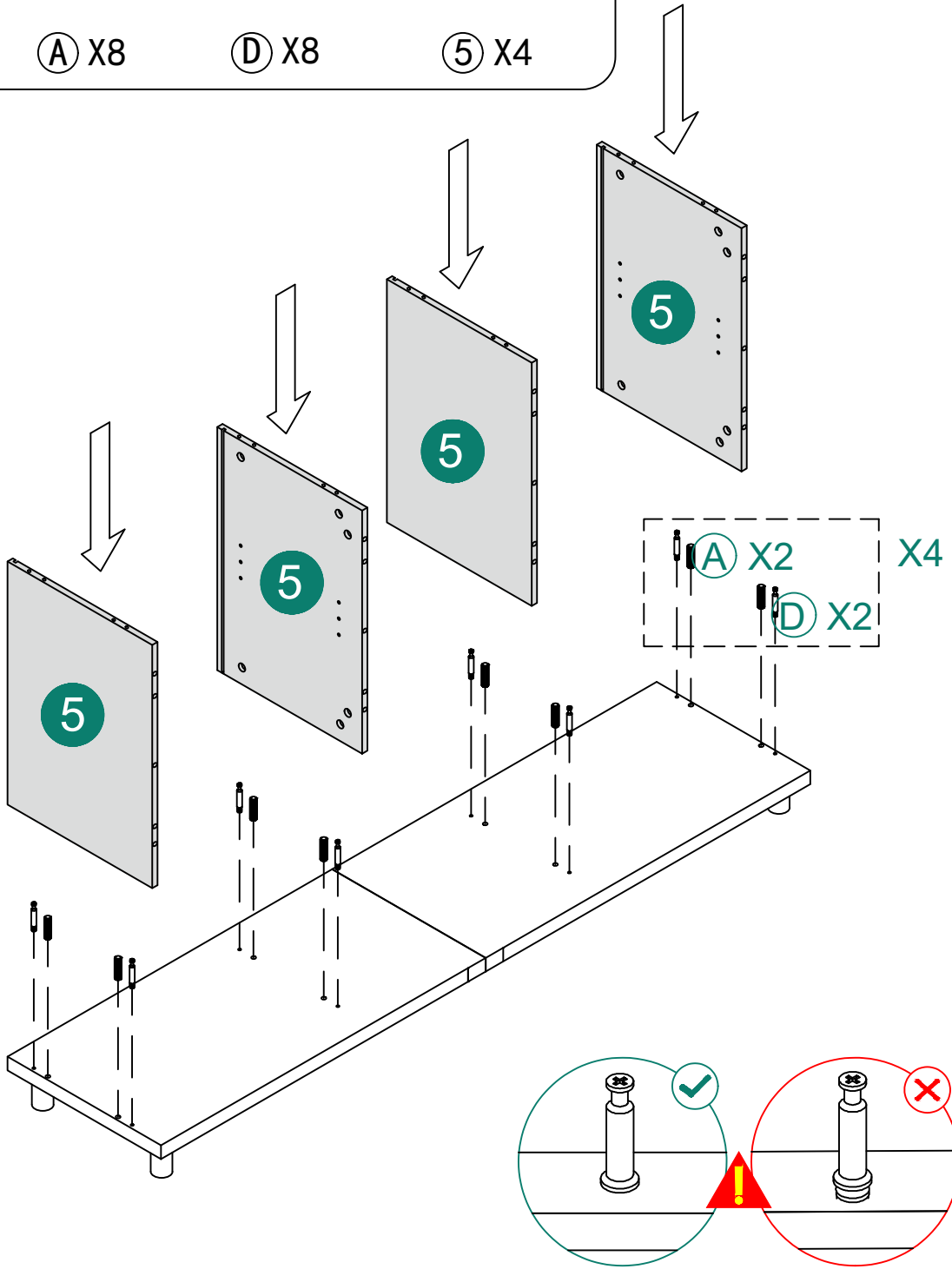

4

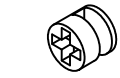

Ⓒ X8

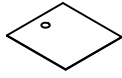

⑥ X2

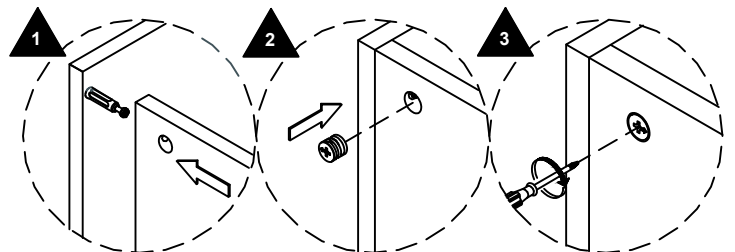
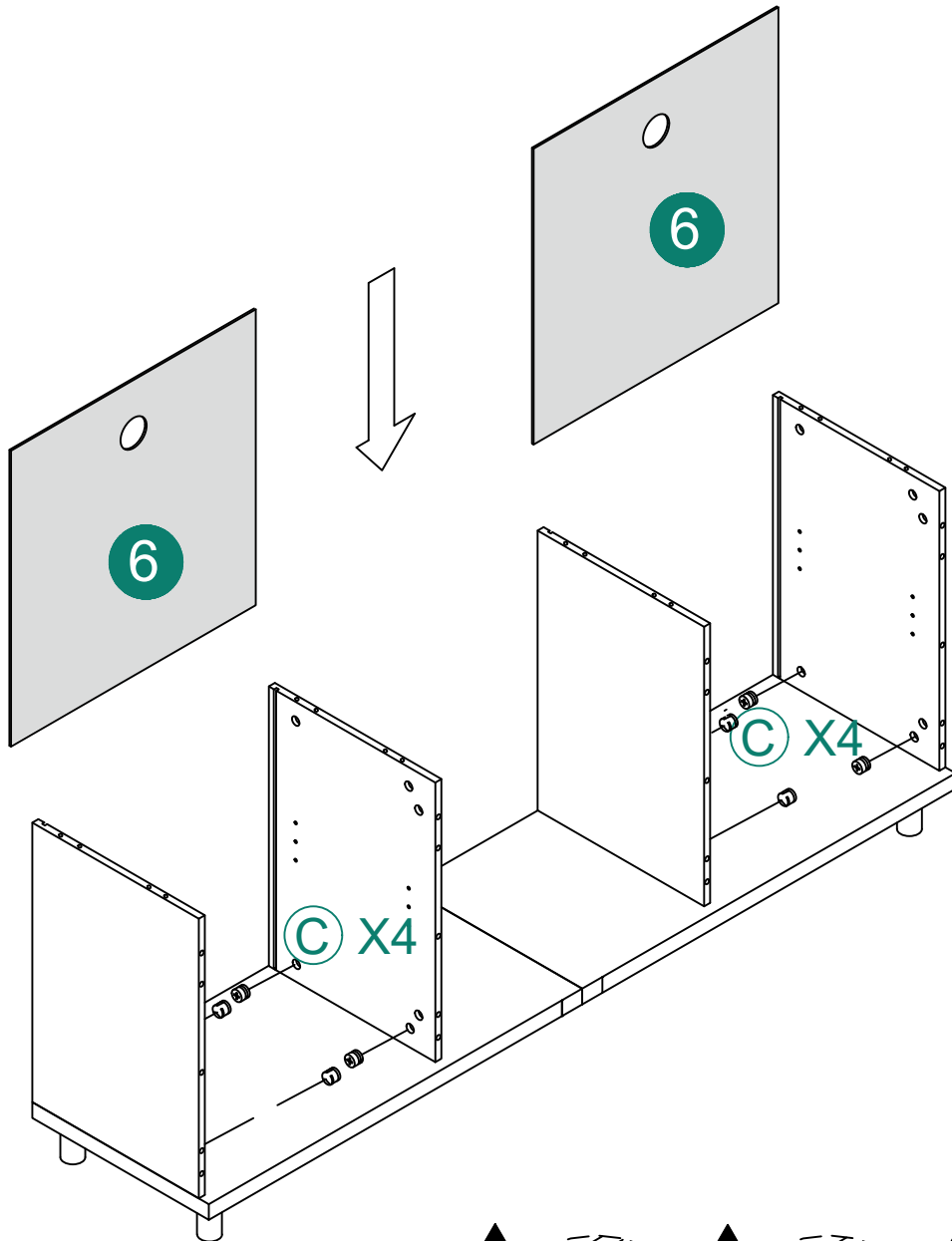

5



(A) X12



(C) X8



(D) X8

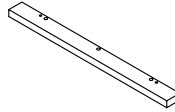

(9) X2

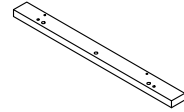

(10) X1

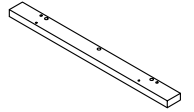

(11) X1

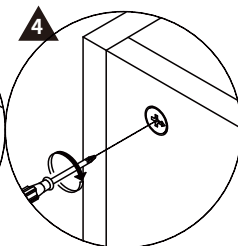
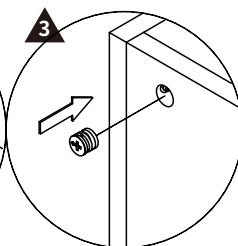
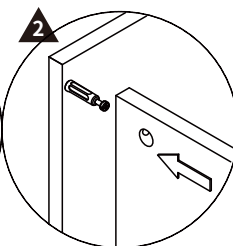
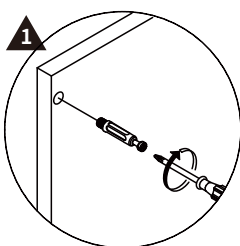
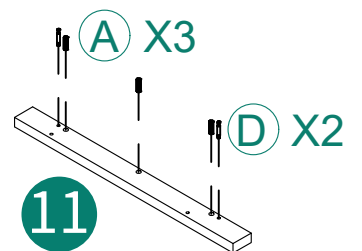
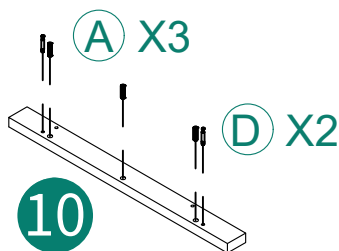
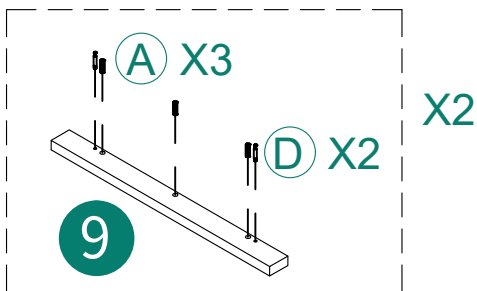
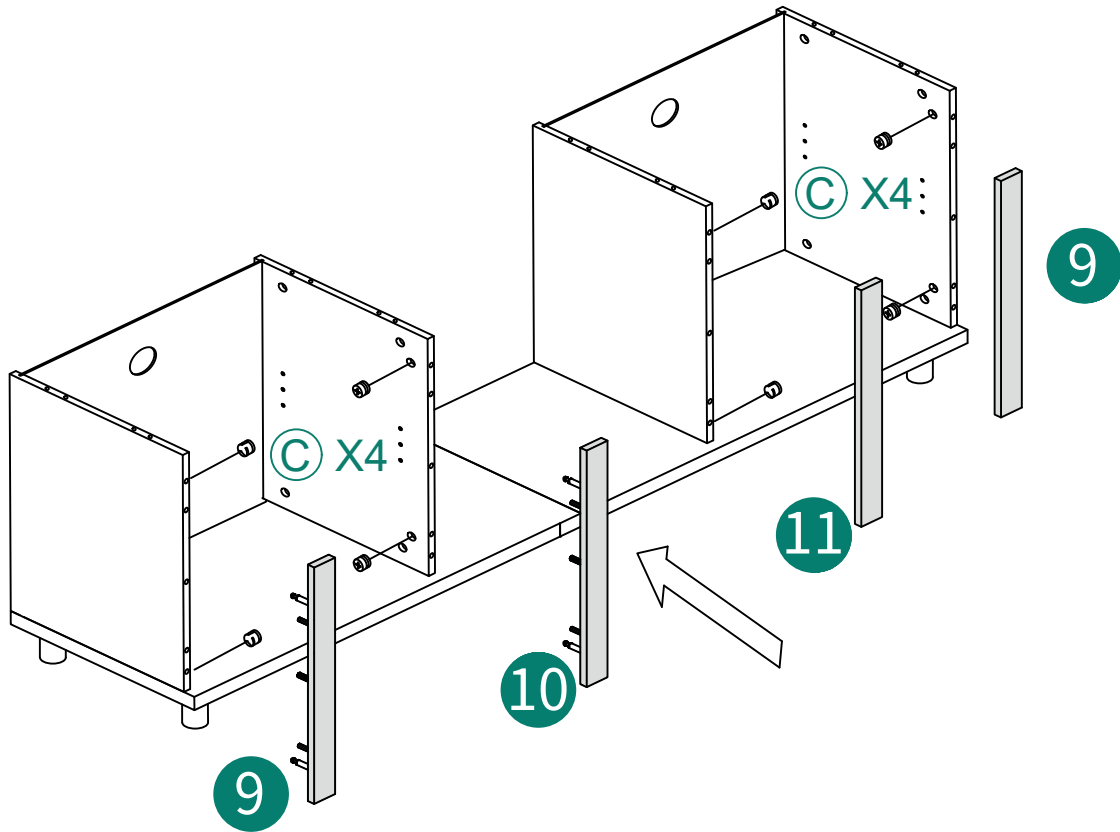

6



Ⓑ X4

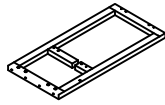

① X1

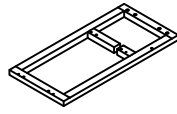

② X1

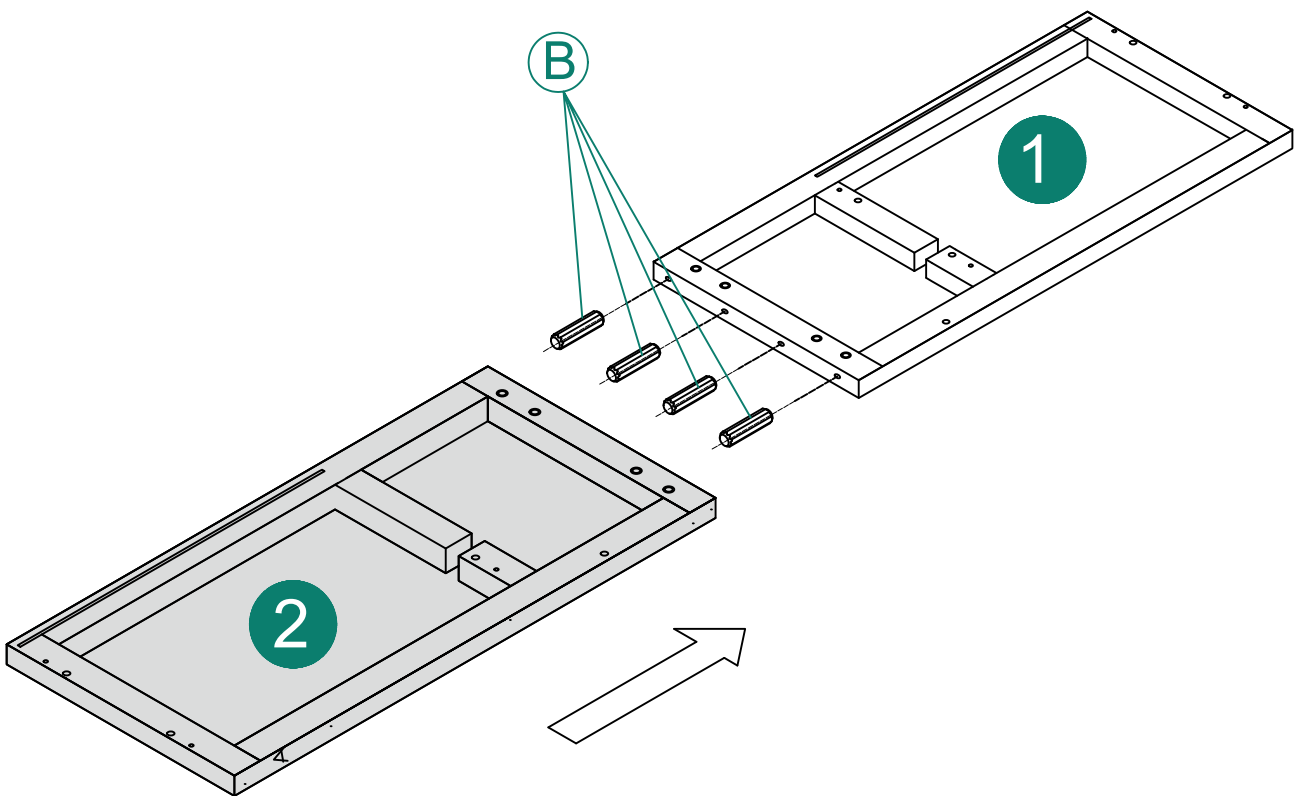

7

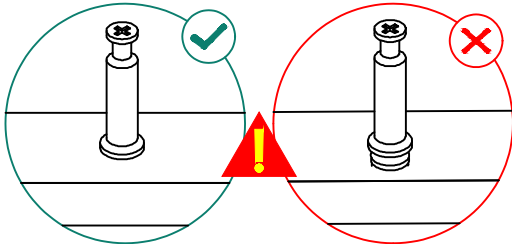
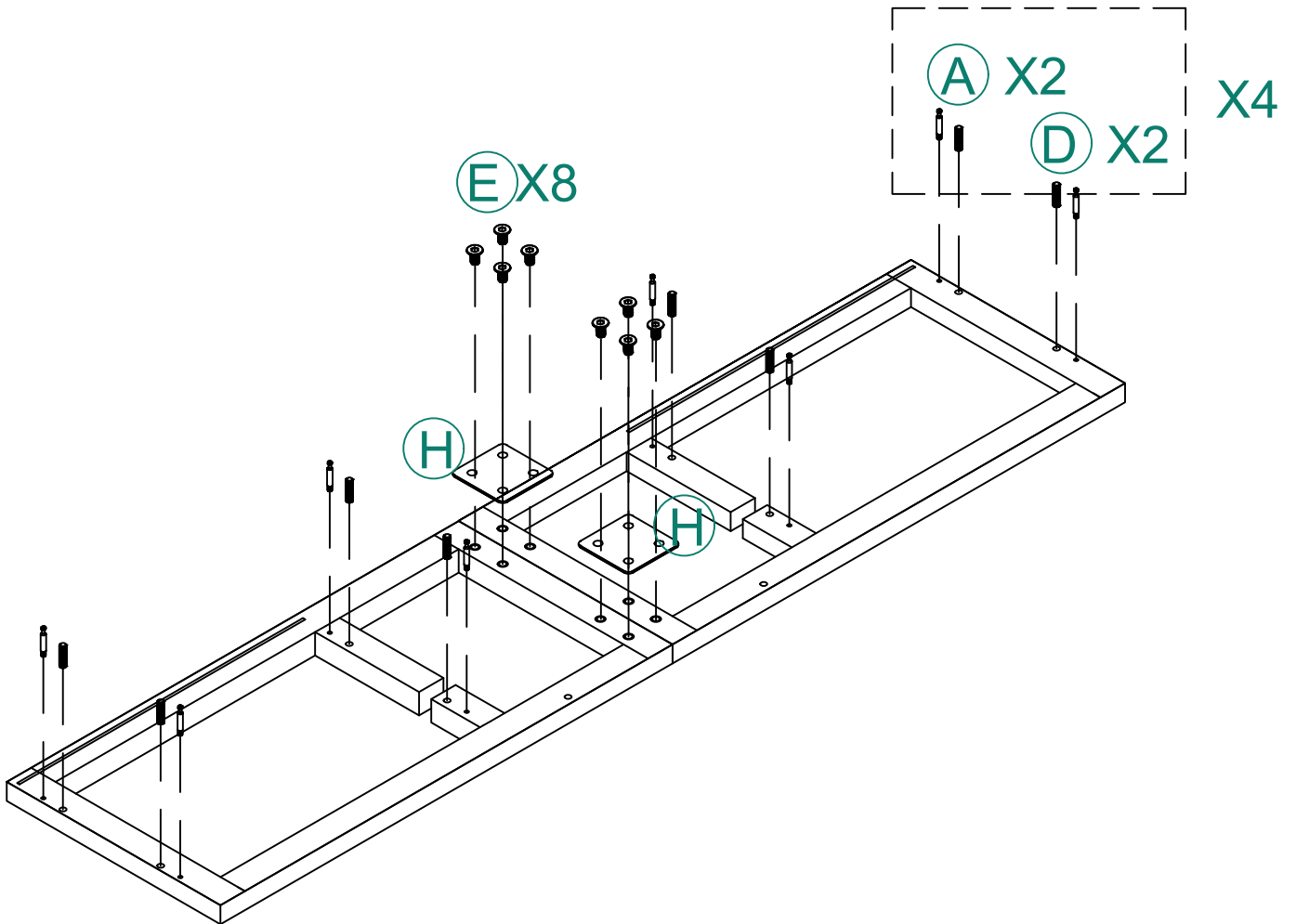
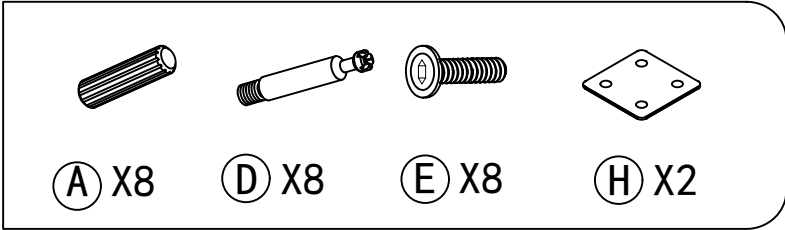

8



(L)X1



(M)X1

EN Please remove the plastic film here before using the remote control.

DE · Bitte entfernen Sie die Plastikfolie hier, bevor Sie die Fernbedienung verwenden.

FR · Veuillez retirer le film plastique ici avant d'utiliser la télécommande.

IT · Si prega di rimuovere la pellicola di plastica qui prima di utilizzare il telecomando.

ES · Por favor, retire la película plástica aquí antes de usar el mando a distancia.

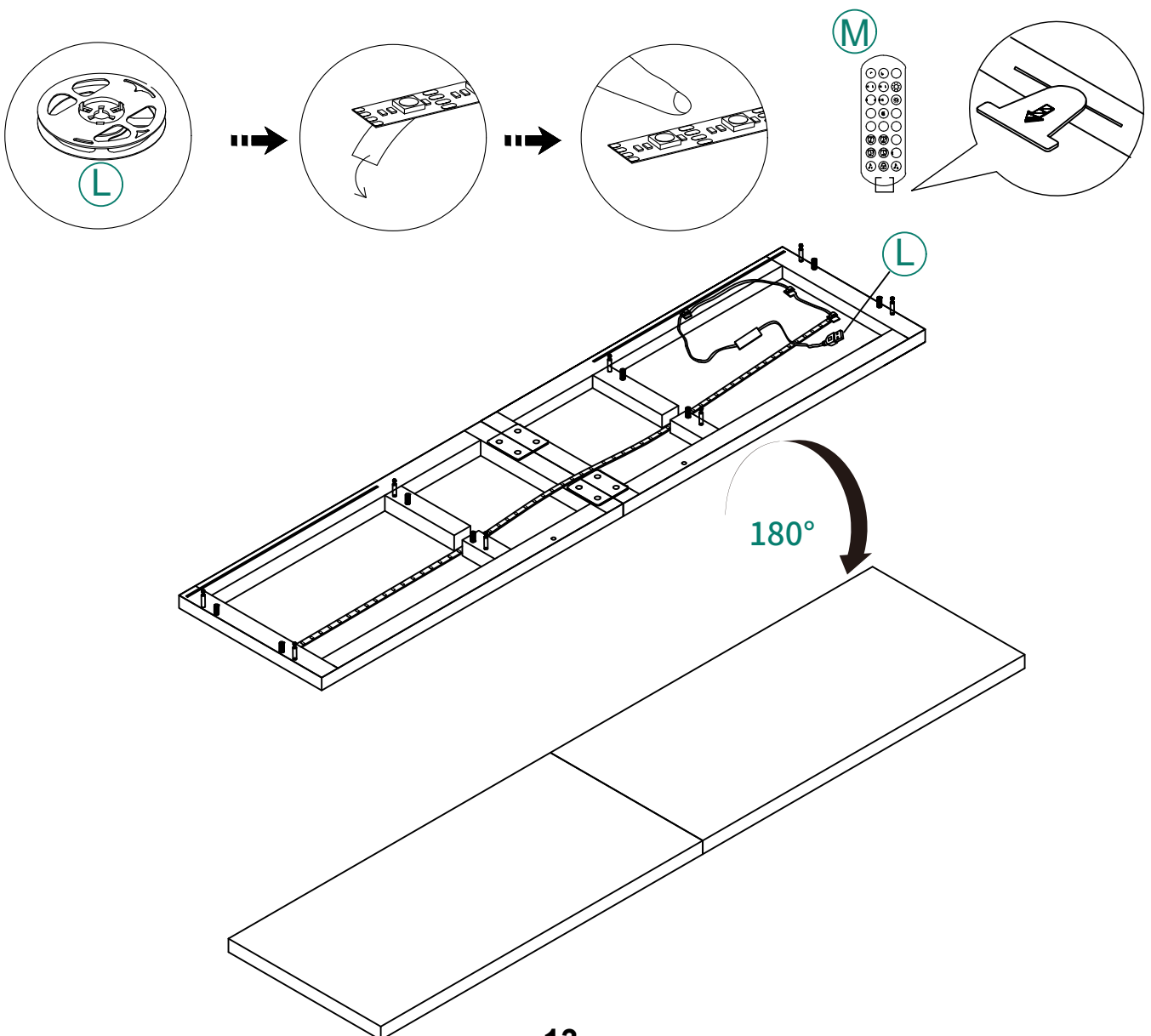

9

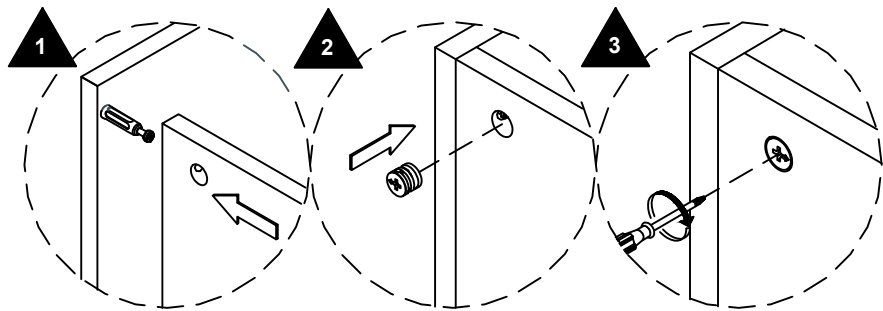
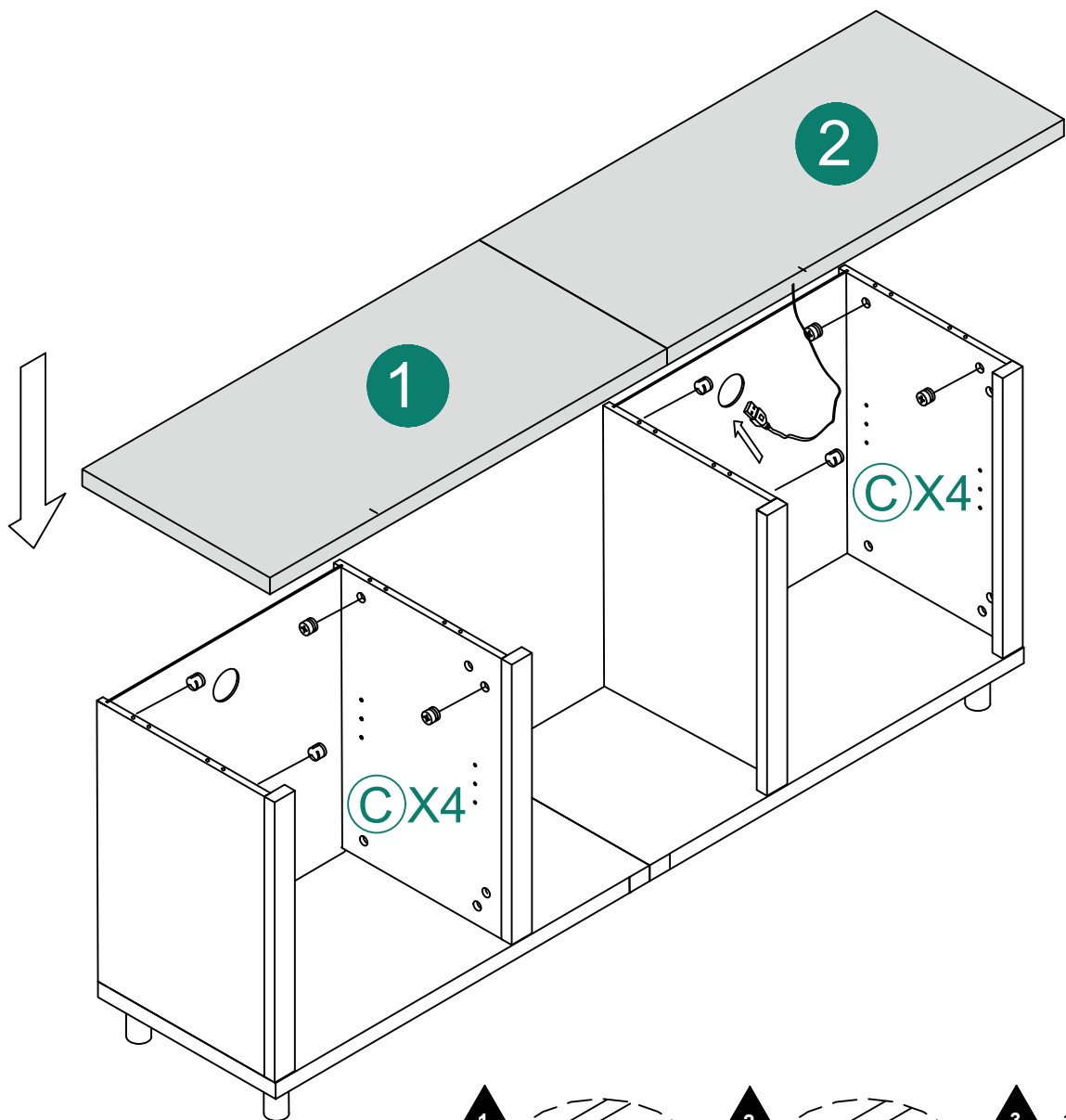
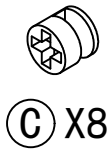

10



(A) X2

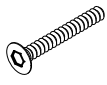

(F) X2

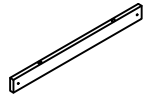

(8) X1



(J) X24

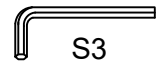

(P) X1

S3

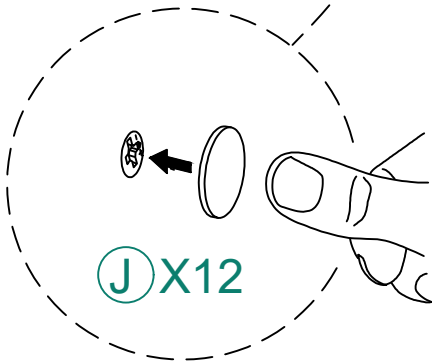
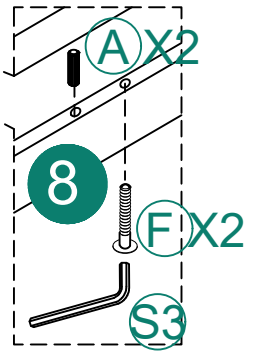
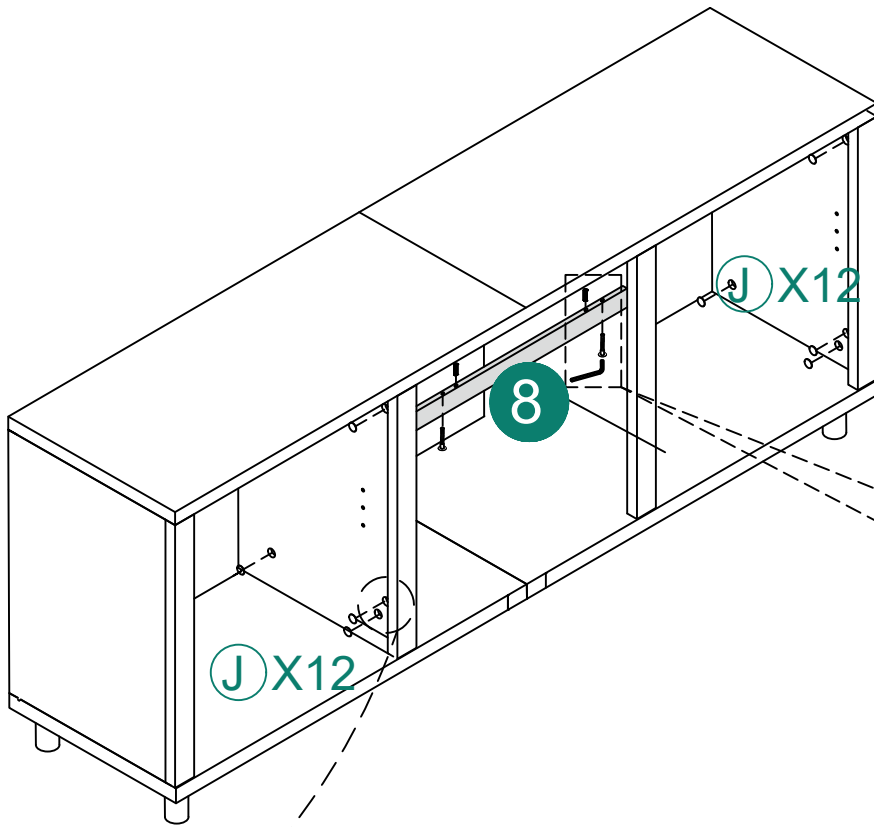

11

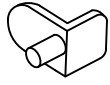

① X8

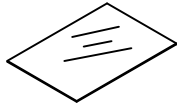

⑦ X2

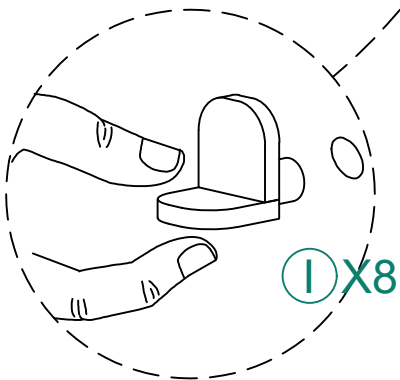
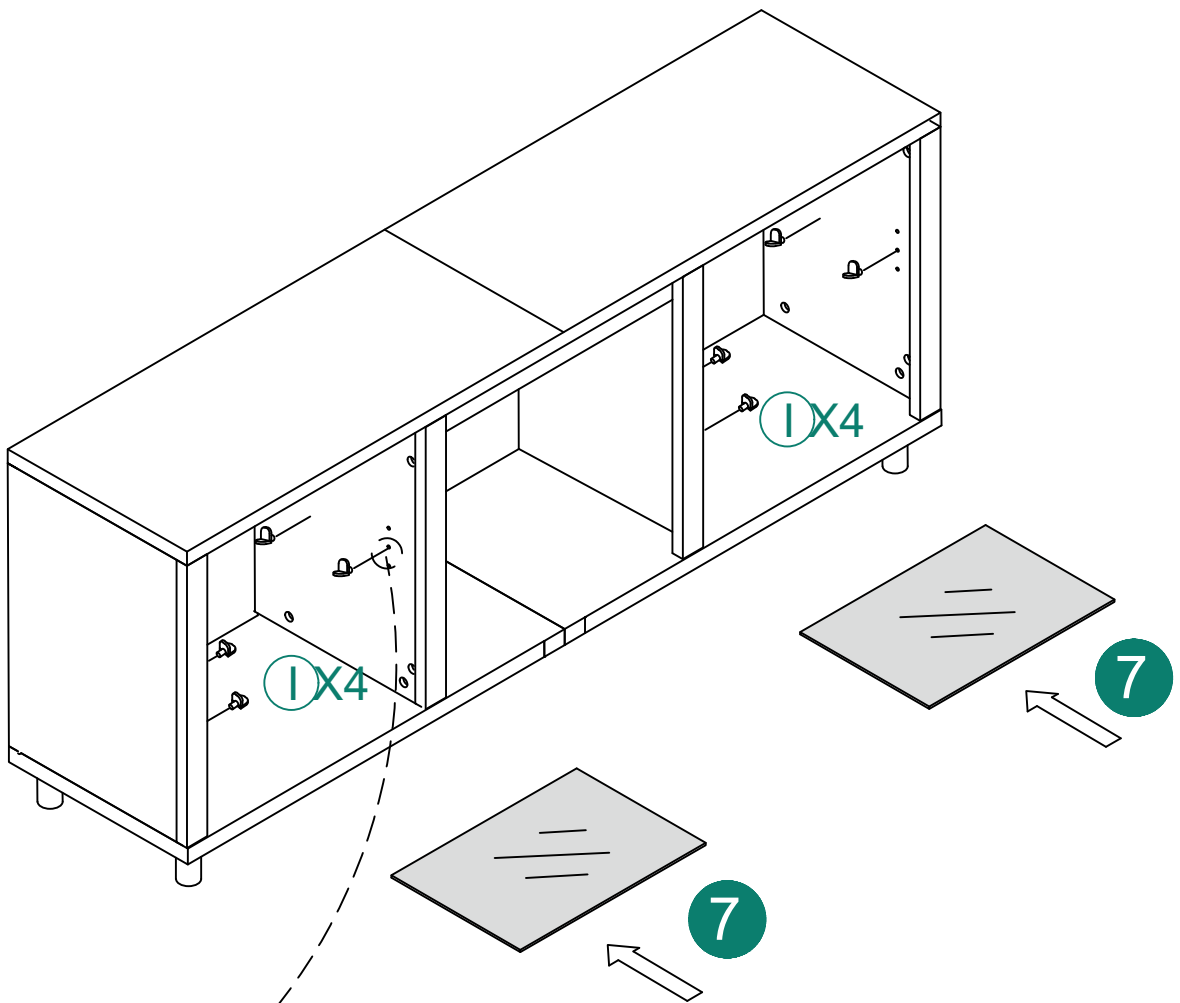

12



N) X1



O) X4

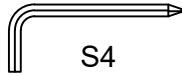

S4

P) X1

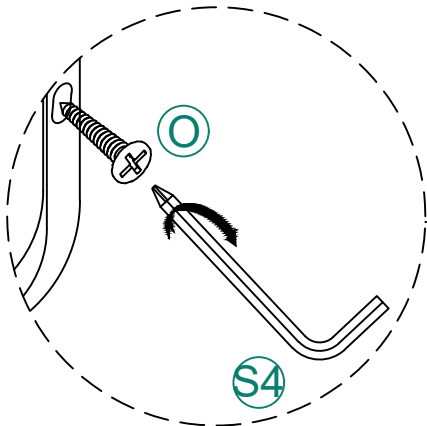
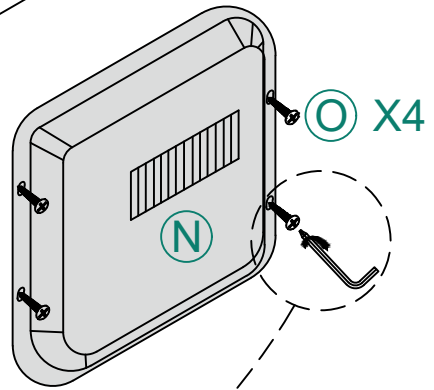
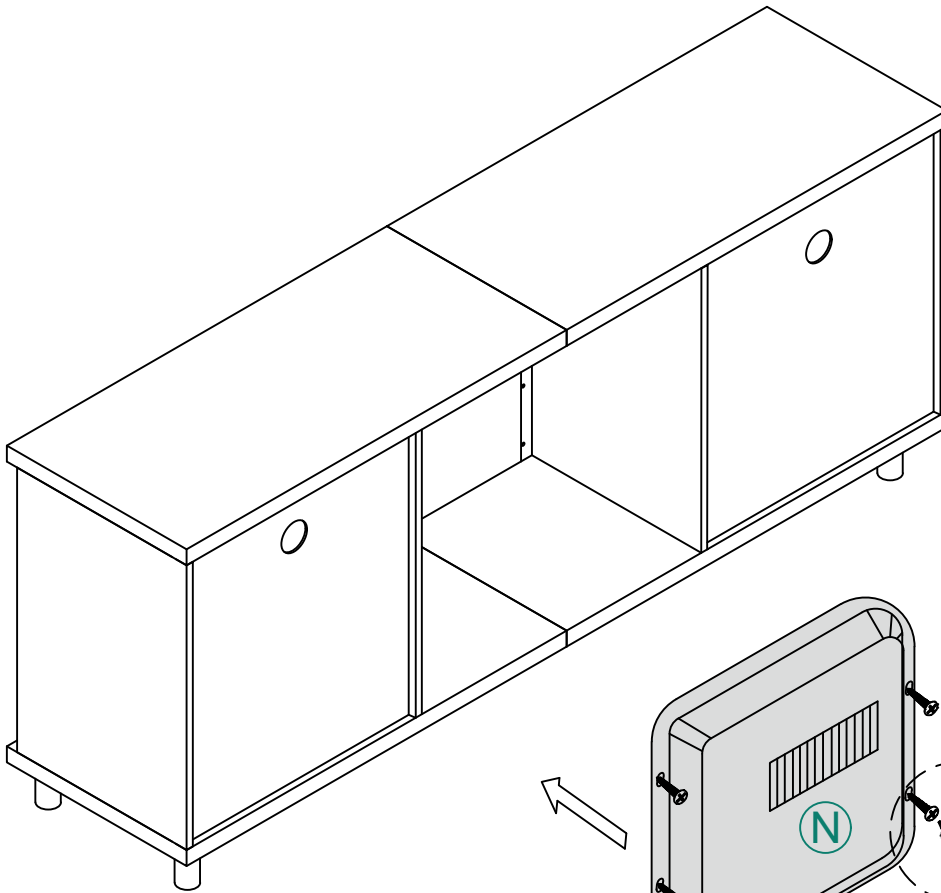

13

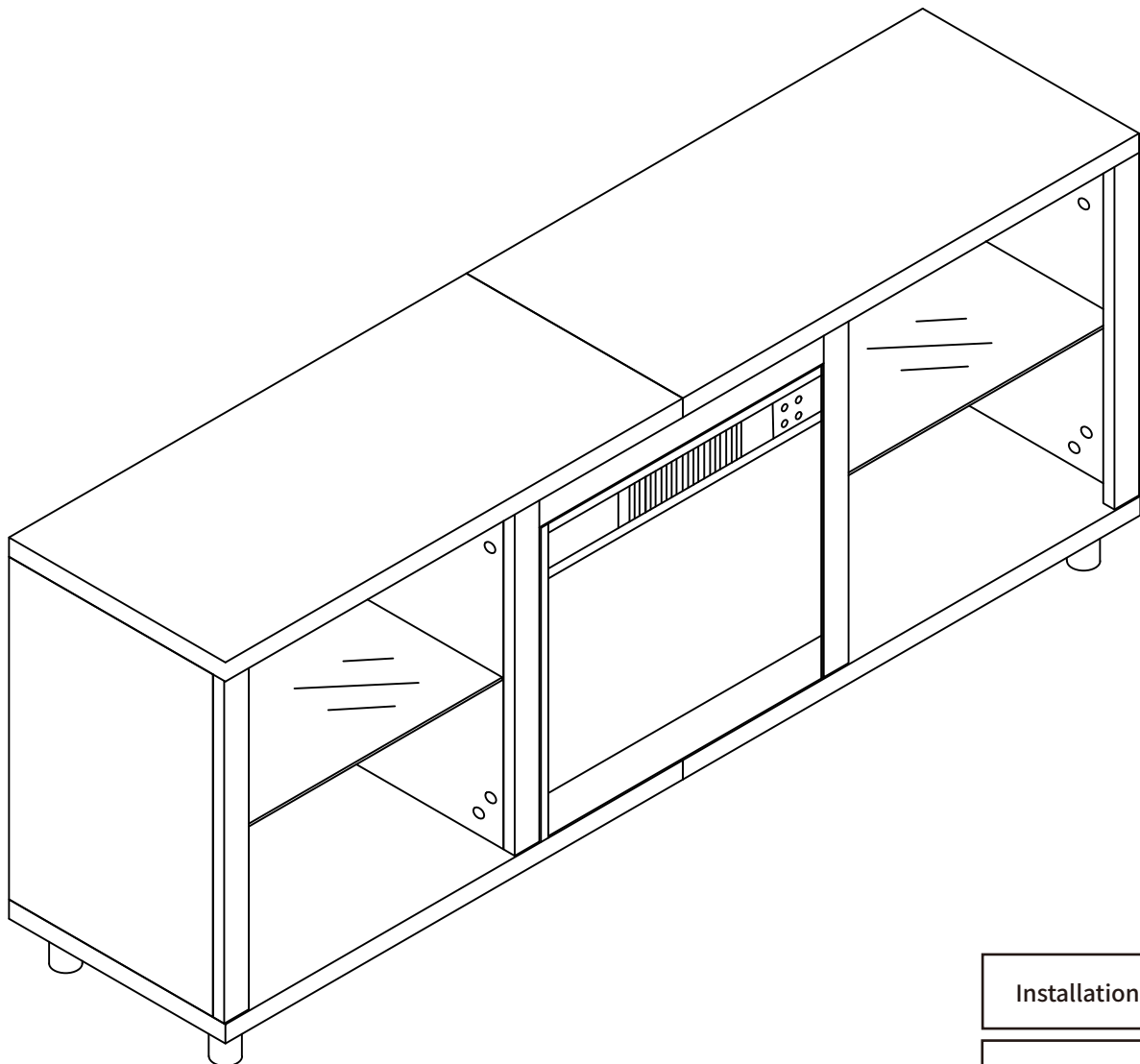

Installation Completed

Installation Abgeschlossen

Installation Complétée

Installazione Completata

Instalación Completada

HELP CENTER



Inquiry



Assembly issue



Missing parts

If you encounter any difficulties during assembly, please contact us.

Wenn Sie während der Montage auf Schwierigkeiten stoßen, kontaktieren Sie uns bitte.

Si vous rencontrez des difficultés lors du montage, veuillez nous contacter.

Se incontri difficoltà durante il montaggio, ti preghiamo di contattarci.

Si encuentras alguna dificultad durante el ensamblaje, por favor contáctanos.

DISCLAIMER

Manufacturer and seller expressly disclaim any and all liability for personal injury, property damage or loss, whether direct, indirect, or incidental, resulting from the incorrect attachment, improper use, inadequate maintenance, unapproved modification, or neglect of this product.

Der Hersteller und Verkäufer lehnen ausdrücklich jegliche Haftung für Personenschäden, Sachschäden oder Verluste ab, egal ob direkt, indirekt oder zufällig, die durch falsche Anbringung, unsachgemäßen Gebrauch, unzureichende Wartung, nicht genehmigte Änderungen oder Vernachlässigung dieses Produkts entstehen.

El fabricante y vendedor renuncian expresamente a toda responsabilidad por lesiones personales, daños materiales o pérdidas, ya sean directos, indirectos o incidentales, derivados de la incorrecta colocación, uso inadecuado, mantenimiento insuficiente, modificación no aprobada o negligencia de este producto.

Il produttore e il venditore declinano espressamente ogni responsabilità per lesioni personali, danni materiali o perdite, dirette, indirette o incidentali, derivanti dall'errato fissaggio, uso improprio, manutenzione inadeguata, modifica non autorizzata o negligenza di questo prodotto.

Le fabricant et le vendeur déclinent expressément toute responsabilité en cas de blessures corporelles, de dommages matériels ou de pertes, qu'ils soient directs, indirects ou accessoires, résultant de la fixation incorrecte, de l'utilisation inappropriée, de l'entretien insuffisant, de la modification non approuvée ou de la négligence de ce produit.