

BOOKCASE

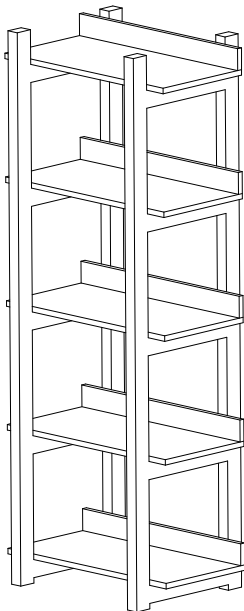



Thank you for purchasing the **BOOKCASE**!

Before you start, here is some helpful advice:

1. We suggest you spend a short time reading through this leaflet and then follow the simple step-by-step instructions.
2. Owing to the size and weight of the bookcase, we recommend that it is assembled by two adults, on a carpeted or padded area, in the room that it is intended for. Approximate assembly time: 30 minutes.
3. Please do not use any tools other than those provided or recommended in these instructions.
4. Please do not throw away any of the packaging or the instruction until you have checked all the components and hardware and the furniture is fully assembled. Please ensure that the packaging is disposed of in a safe and environmentally friendly way.
5. Assemble all components loosely until advised to tighten. Depending on use, it may be necessary to tighten the components from time to time, so please save the tools that have been provided.
6. Please keep all fitting out of reach of children.



Hardware:

A		Cam	x10
B		Cam Post	x10
C		Bolt M6x60mm	x30
D		Allen Wrench M4	x1
		Phillips Head Screwdriver (Not included)	

Component:

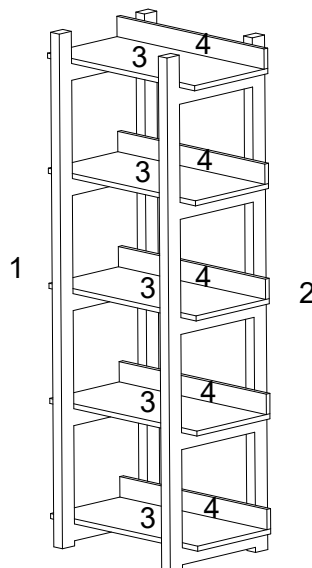

1	Left Frame	x1	2	Right Frame	x1	3	Shelf	x5	4	Back Panel	x5
---	------------	----	---	-------------	----	---	-------	----	---	------------	----

HOW TO USE CAM AND CAM POST HARDWARE

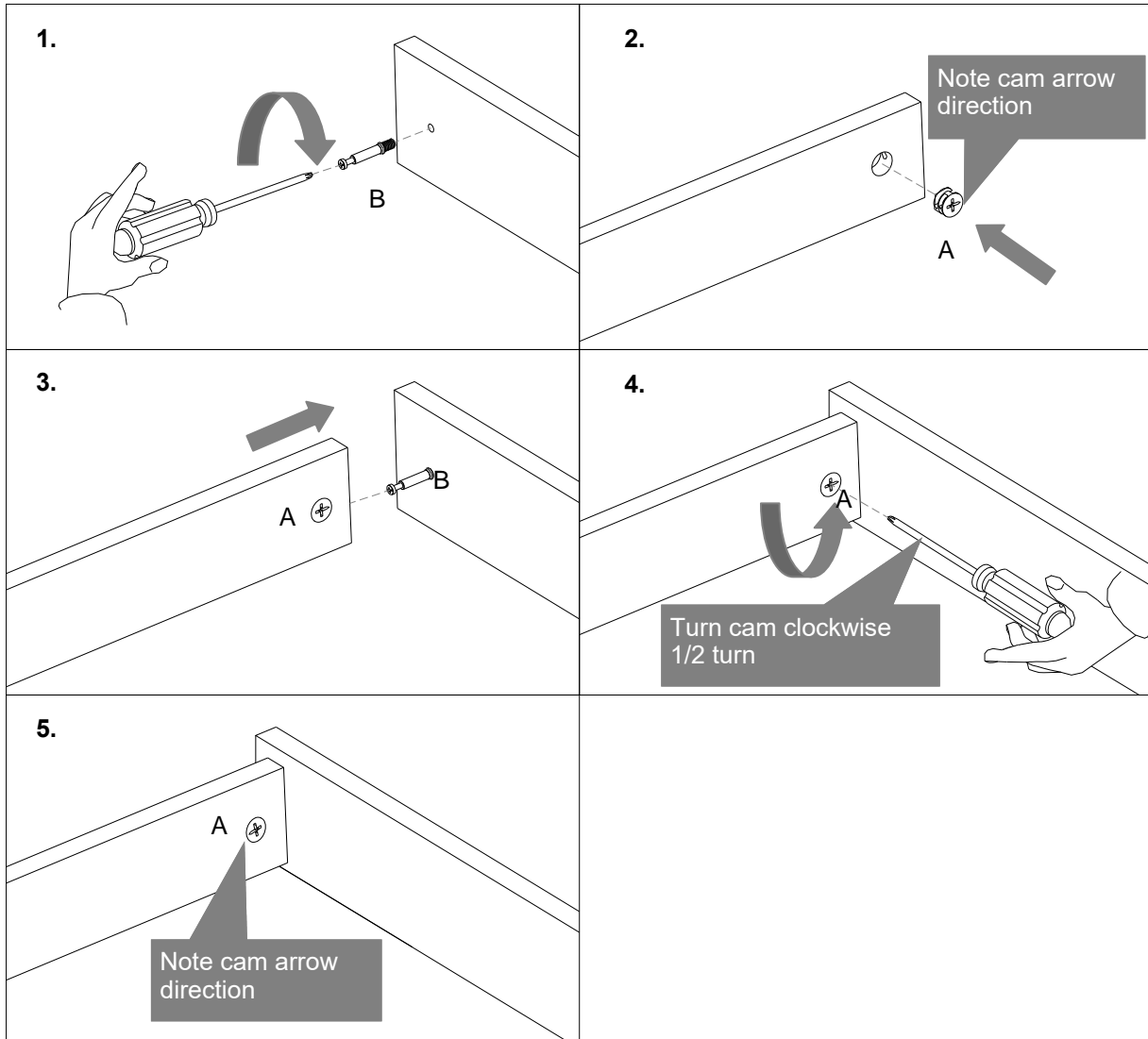

STEP 1:



Put 1 piece of **Shelf (3)** to 1 piece of **Back Panel (4)** together..

Attach them by using 2 pieces of **Cam Post (B)** and 2 pieces of **Cam (A)**

Fully tighten **Cams (A)** by using **Phillips Head Screwdriver** (not included).

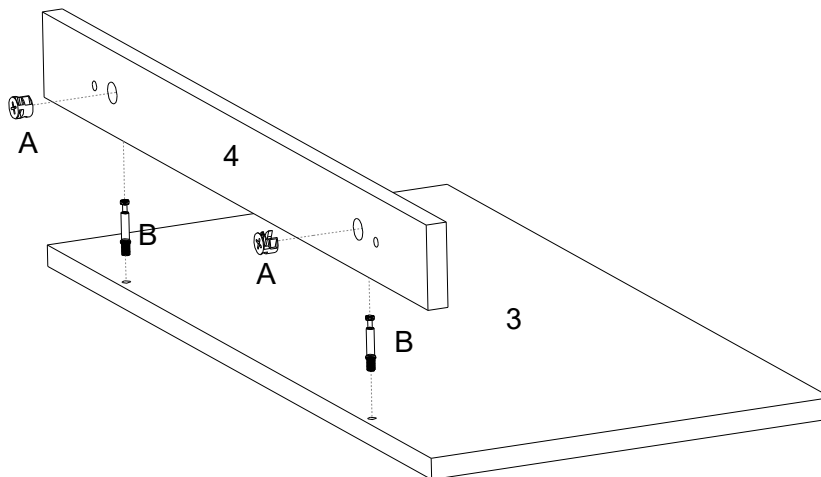
Repeat the same steps for the remaining assembled **Shelves (3)** and **Back Panels (4)**.

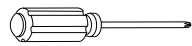

		
Ax10	Bx10	Phillips Head Screwdriver (not included)

Hardware & Tools required

BOOKCASE

STEP 2:

Put **Left Frame (1)** and **Right Frame (2)** to the assembled **Shelves (1)** and **Back Panel (2)** as shown. Attach 1 piece of assembled **Shelf (3)** and **Back Panel (4)** to **Left Frame (1)** and **Right Frame (2)** by using 6 pieces of **Bolt (C)**.

Repeat the same steps for the remaining assembled **Shelves (3)** and **Back Panels (4)**.

Use **Allen Wrench (D)** to tighten **Bolts (C)** clockwise until secure.

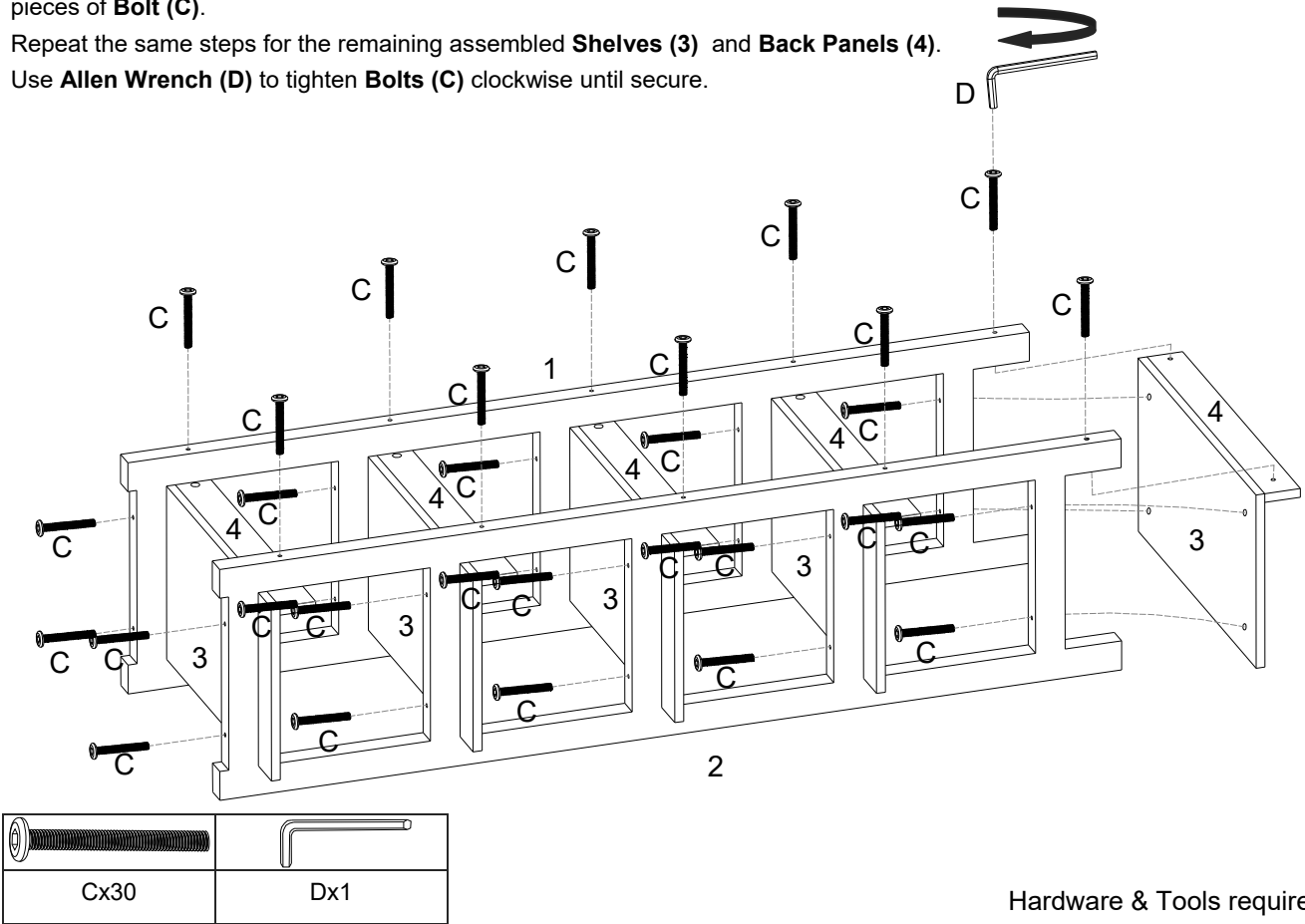

STEP 3:

Carefully turn up the assembled bookcase.

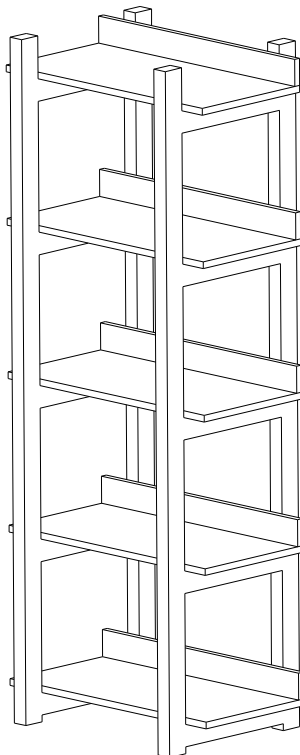

Assembly is complete. Your bookcase is ready to be used now!