

CAUTION



DO NOT DISCARD THIS MANUAL

- Important operating and maintenance instructions included.
- Read, understand, and follow these instructions for safe installation and operation.



DANGER

If you smell gas:

- Shut off gas to the appliance
- Extinguish any open flame.
- If odor continues, keep away from the appliance and immediately call your gas supplier or fire department.



WARNING



HOT! DO NOT TOUCH.

SEVERE BURNS MAY RESULT.

CLOTHING IGNITION MAY RESULT.

Glass and other surfaces are hot during operation and cool-down.

- Young children should be carefully supervised when they are in the area of the appliance
- Children and adults should be alerted to the hazards of high surface temperatures and should stay away to avoid burns or clothing ignition
- Clothing or other flammable materials should not be hung from the appliance or placed on or near the appliance.

Any guard or other protective device removed for servicing the appliance shall be replaced prior to operating the appliance



WARNING

Do not store or use gasoline, or other flammable vapors and liquids, in the vicinity of this or any other appliance. An LP-cylinder not connected for use shall not be stored in the vicinity of this or any other appliance.



WARNING: For outdoor use only



WARNING



Improper installation, adjustment, alteration, service, or maintenance can cause injury or property damage. Read the installation and maintenance instructions thoroughly before installing or servicing this equipment.



DANGER



CARBON MONOXIDE HAZARD

This appliance can produce carbon monoxide which has no odor.

Using it in an enclosed space can kill you.

Never use this appliance in an enclosed space such as a camper, tent, car, or home.

Read this manual before installing or operating this appliance.

Please retain this owner's manual for future reference.

Congratulations

Congratulations on selecting an Outdoor GreatRoom Company decorative gas appliance. The Crystal Fire™ burner you have selected is designed to provide the utmost in safety, reliability, and efficiency.

As the owner of a Crystal Fire™, you'll want to read and carefully follow all of the instructions contained in this owner's manual. Pay special attention to all cautions and warnings.

This owner's manual should be retained for future reference. We suggest you keep it with other important documents and product manuals.

This information contained in this owner's manual, unless noted otherwise, applies to all models and gas control systems.

Your new Crystal Fire™ will give you years of durable use and trouble-free enjoyment.

Homeowner Reference Information

We recommend that you record the following pertinent information about your appliance

Model name: _____ Date of purchase/installation _____

Serial Number: _____ Location on appliance: _____

Dealer purchased from: _____ Dealer Phone: _____

Notes: _____

Listing Label Information/Location

The model information regarding your specific appliance can be found on the rating plate attached to your burner via a metal chain. See the **sample** rating plate at right for locations of specifications.

GAS-FIRED
UL LISTED 42W4
DECORATIVE OUTDOOR GAS-FIRED FIREPLACE

The Outdoor GreatRoom Company
2015 Silver Bell Road, #195
Eagan, MN 55122

Model: All Crystal Fires ANSI Z21.97-2014 and CSA 2.41-2014 for Canada. Installation must conform with local codes or in the absence of local codes, ANSI Z223.1 * NFPA 54 National Fuel Gas Code – Natural gas and propane installation code, CSA B149.1 – or propane storage and handling code CSA B149.2

Model	LP	NZ	LP	NZ
CF-20 NF-28	#43	#51	55333	51706
CF-3224 NF-719	#43	#51	55333	51706
CF-3424 NF-3519	#36	#17	79229	107465
CF-3242 NF-737	#51	#21	100588	90776
CF-3264	#51	#21	100588	90776
CF-32120 CF-3242-L	#31(2)	#21(2)	100588 (per half)	90776 (per half)
CF-30	#51	#17	90,000	90,000
CF-32	#55	#40	20000	10500

WARNING: Must Not Be Used For Cooking.
WARNING: For Outdoor Use Only. If stored indoors, detach and leave cylinder outdoors.
MINIMUM CLEARANCES: Top: 6 Ft. (72") Sides: 2 Ft. (24") Bottom: 8 In.
Minimum clearance from sides and back of unit to adjacent combustible construction below top of unit is 8 inches from sides and 8 inches from back.
Minimum horizontal clearance from sides and back of unit to adjacent vertical combustible construction extending above top of unit is 24 inches from sides and 24 inches from back.

WARNING: Improper installation, adjustment, alteration, service or maintenance can cause injury or property damage. Refer to the owner's information manual provided with this appliance. For assistance or additional information consult a qualified installer, service agency or the gas supplier.

CF-UL Rev E 9/18/15

Table of Contents

1. Listing and Code Approvals

- a. Appliance certification
- b. BTU specifications

2. Getting Started

- a. Design and installation considerations
- b. Tools and supplies required
- c. Inspect the appliance and components

3. Framing and Clearances

- a. Clearances to Combustibles
- b. Framing and Enclosure for LP Gas Supply

4. Setting up your Burner

- a. Burner Assembly
- b. Glass Installation
- c. Igniter Installation and Grounding

5. Gas Hookup and Information

- a. Fuel
- b. Gas pressure
- c. Gas connection
- d. LP Gas supply

6. Lighting and Operation

7. Finishing

8. Troubleshooting

9. Service and Maintenance

10. Reference Materials

- a. Service parts list
- b. Contact information
- c. Limited one-year warranty

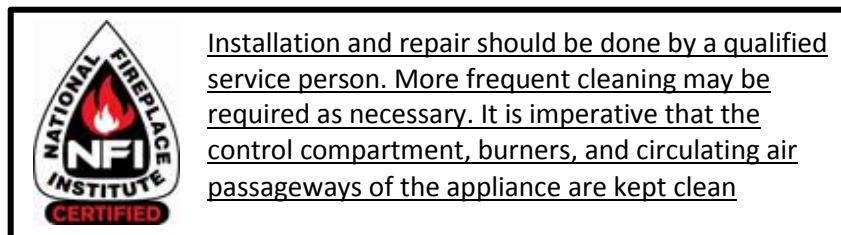

What's included...

ROUND FT41R

CF20-LP

- Burner assembly
- Black propane hose with regulator
- Flexible metal gas line
- Ball valve
- Piezoelectric igniter
- #43 Orifice (LP)
- #31 Orifice (NG)
- 2 bags of decorative glass

SQUARE FT4040/SFT4242

CF-2424

- Burner assembly
- Black propane hose with regulator
- Flexible metal gas line
- Ball valve
- Piezoelectric igniter
- #36 Orifice (LP)
- #17 Orifice (NG)
- 4 bags of decorative glass

RECTANGLE FT6030/SFT6030

CF-1242

- Burner assembly
- Black propane hose with regulator
- Flexible metal gas line
- Ball valve
- Piezoelectric igniter
- #31 Orifice (LP)
- #21 Orifice (NG)
- 3 bags of decorative glass

A. Appliance Certification

MODEL: CRYSTAL FIRE CF-20-LP, CF-12, CF-30, CF-1616, CF-1224, CF-1242, CF-2424, CF-1242-L, NF-719, NF-737, NF-16, NF-1919, CF-1264, CF-12120

LABORATORY: Underwriters Laboratories, Inc. (UL)

TYPE: Decorative Gas-Fired Outdoor Fireplace

STANDARD: Out Decorative Gas Appliances ANSI Z21.97-2014 * CSA 2.41-2014

The Crystal Fire has been tested in accordance with ANSI Z21.97-2014 and CSA 2.41-2014 for Canada and has been listed by Underwriters Laboratory (UL) for installation and operation as described in these installation and operating instructions.

The installation must conform with local codes or, in the absence of local codes, ANSI Z223.1 * NFPA 54 *National Fuel Gas Code – Natural Gas and Propane Installation Code*, CSA B149.1 – or *Propane Storage and Handling Code*, CSA B149.2

B. BTU Specifications

Model	Orifice Size		Max input BTU	
	LP	NG	LP	NG
CF-20 ROUND FT41R	#43	#31	55331	51706
CF-1242 RECTANGLE FT6030/SFT6030	#43	#31	55331	51706
CF-2424 SQUARE FT4040/SFT4242	#36	#17	79229	107465
CF-1242 RECTANGLE FT6030/SFT6030	#31	#21	100588	90776

FOR DIY FIRE PIT MODELS

- DIY-38 uses an NF-1919 burner
- DIY-2032 uses an NF-719 burner
- DIY-2049 uses an NF-737 burner

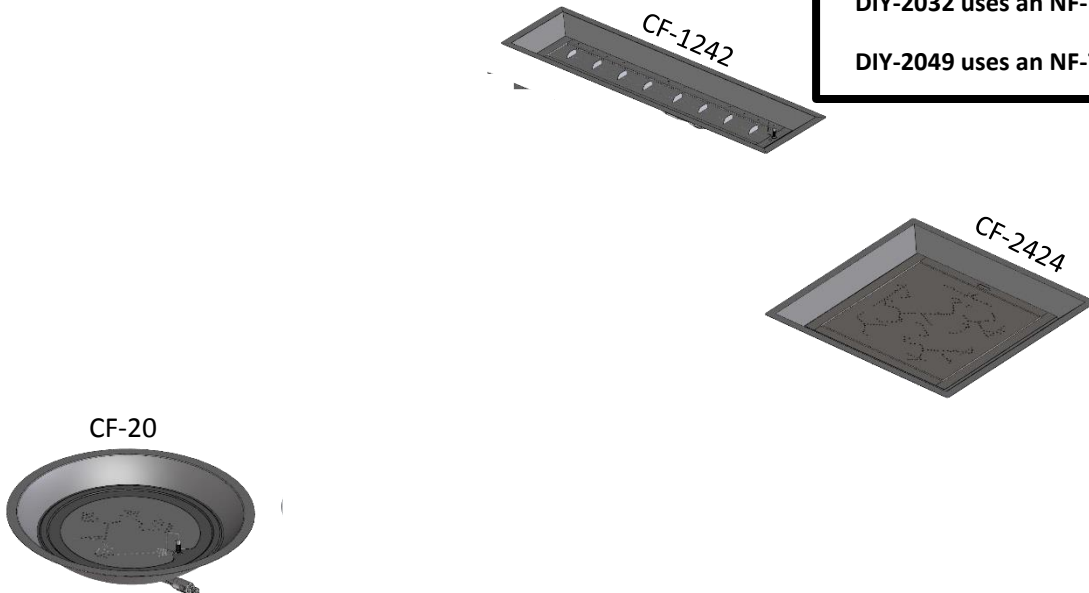

*For reference only. Burners not to scale

This appliance is a Decorative Gas Appliance for **OUTDOOR USE ONLY** and **MUST NOT** be used for cooking.

Place the Crystal Fire on a flat and stable surface in an outdoor location such as a patio or deck. This location must be adjacent to the gas supply line or LP gas supply cylinder. **DO NOT** locate the appliance where it will get excessively wet or submerged in water.

A. Design and Installation Considerations



When planning an appliance installation, it's necessary to determine the following information before installing:



- Where will the appliance be installed? **See section 3**
- Gas supply piping. **See section 4**
- Framing and finishing details. **See sections 3,7**



B. Tools and Supplies Required

Before beginning the installation, be sure that the following tools and supplies are at hand.



- Gloves
- Safety Glasses
- Phillips screwdriver
- Non-corrosive leak-check solution
- Wrenches
- 1 AAA battery

	WARNING	
	<p>The Outdoor GreatRoom Company disclaims any responsibility for, and the warranty will be voided by, the following actions:</p> <ul style="list-style-type: none"> • Installation and use of any damaged components. • Modification of the burner assembly • Installation other than as instructed by the Outdoor GreatRoom Company. <p>Any such action may cause a fire hazard</p>	



	WARNING	
<p>Asphyxiation Risk</p> <ul style="list-style-type: none"> • This gas appliance is for outdoor use in a well-ventilated space. • This unit must not be installed inside an enclosed structure or unvented appliance 		

	WARNING	
<p>Do NOT use this appliance if any part of it has been underwater. Have a qualified service technician inspect the appliance and replace any part of the control system and any gas control which has been underwater.</p>		

CAUTION		
<p>Sharp Edges Wear protective gloves and safety glasses during installation.</p>		

	WARNING	
<p>Do not burn solid fuels in this gas appliance</p>		



C. Inspect the Appliance and Components

	WARNING	
<p>Inspect appliance and components for damage. Damaged parts may impair safe operation.</p> <ul style="list-style-type: none"> • Do NOT install damaged, incomplete, or substitute components Report damaged parts to your dealer. 		

- Carefully remove all burner components from packaging.
- Read all instructions before beginning installation. Follow these instructions carefully during installation to ensure maximum safety and benefit.

Note:

- Illustrations reflect typical installations and are **FOR DESIGN PURPOSES ONLY.**
- Illustrations/diagrams are not drawn to scale.
- Actual installation may vary due to individual design preference.

	WARNING	
	<p>Fire Risk</p> <p>Provide adequate clearance:</p> <ul style="list-style-type: none"> • Around air openings • For service access. <p>Locate appliance away from traffic areas</p>	

A. Clearances to combustibles

If you are not using an Outdoor GreatRoom Company table with this burner, be sure to mount to a non-combustible surface maintaining at least 8" to combustible surfaces and framing below the surface of burner.

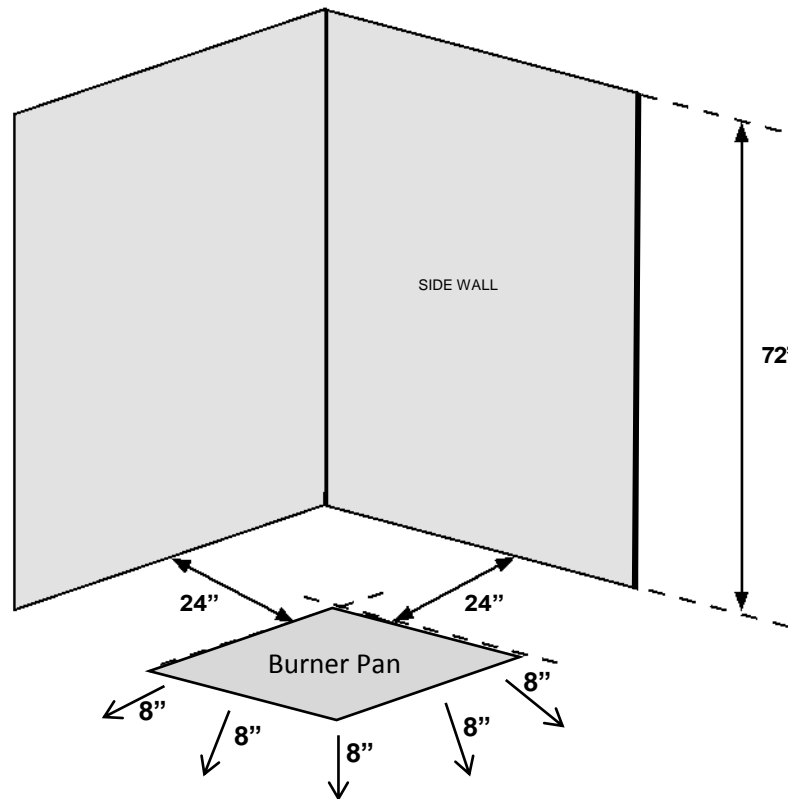

Figure 3.1 Clearances to Combustibles

B. Framing Enclosure for LP Gas Supply System

If you build an enclosure for an LP gas cylinder, follow these recommended specifications and local codes:

Ventilation

Enclosures must be ventilated by openings at the level of the cylinder valve and at floor level. Effectiveness must be determined with the cylinder(s) in place.

6002/3-FT41R

- One side of the enclosure must be completely open or,
- For an enclosure having four sides, a top and a bottom:
 - At least two ventilation openings at cylinder valve level shall be provided in the side wall, equally sized, spaced at 180 degrees (3.14 rad), and unobstructed. Each opening must have a total free area of not less than 1/2 square inch per pound (3.2 sq. cm/kg) of stored fuel capacity and not less than a total free area of 10 square inches (64.5 sq. cm).
 - Ventilation opening(s) must be provided at floor level and shall have a total free area of not less than 1/2 square inch per pound (3.2 sq. cm/kg) of stored fuel capacity and not less than a total free area of 10 square inches (64.5 sq. cm). If ventilation openings at floor level are in a side wall, there must be a least two openings. The bottom of the openings must be at floor level and the upper edge can't be more than 5 in. (127 mm) above the floor. The openings must be equally sized, spaced at 180 degrees (3.14 rad) and unobstructed.
 - Every opening must have minimum dimensions to permit the entrance of a 1/8 inch (3.2 mm) diameter rod.

Accessibility

- Cylinder valves must be readily accessible for hand operation. A door on the enclosure to gain access to the cylinder valves is acceptable, provided it is non-locking and can be opened without the use of tools.
- The design of the enclosure must be such that:
 - The LP gas supply cylinder(s) can be connected, disconnected and the connections inspected and tested outside the cylinder enclosure.
 - Those connections which could be disturbed when installing the cylinder(s) in the enclosure can be leak tested inside the enclosure.
 - Be certain to mount or set the LP gas cylinder on a flat stable surface and retain it to prevent it from tipping.

Minimum Clearances

- There must be a minimum clearance of 2 in. (50.8 mm) between the lower surface of the floor of the LP gas supply cylinder enclosure and the ground.

If using an LP-gas supply cylinder, it must be: Constructed and marked in accordance with the U.S. Department of Transportation (DOT) Specifications for LP-Gas Cylinders, or the standard for Cylinders, Spheres and Tubes for Transportation of Dangerous Goods and Commission, CAN/CSA-B339, as applicable; provided with a listed overfilling prevention device; and provided with a cylinder connection device compatible with the connection for the appliance.

4 Setting up your Burner

A. Burner Assembly

All Models

- Check for damage. Do not use damaged components.
- The hose assembly must be replaced prior to the appliance being put into operation if there is evidence of excessive abrasion or wear, or if the hose is damaged. The replacement hose assembly specified by the manufacturer.
- The burner must be replaced prior to the appliance being put into operation if it is evident that the burner is damaged. The replacement burner assembly specified by the manufacturer.
- Position the assembly in the desired location. This location must be adjacent to the gas supply line. You must have easy access to the gas valve control knob after it is installed and connected to the gas supply because the ON/OFF gas valve is used to turn the burner on and off.

B. Glass Installation

Spread glass out evenly over burner area. Use all glass provided for best effect. Keep glass clear of spark to avoid accidental blockage.

Note:

A percentage of glass beads may arrive split in half. This is normal. Additional beads may split after use. This is also normal due to the physical properties of glass.

LP Gas Models

- Make sure the tank valve is turned completely off (clockwise).
- Ensure the tank valve has the proper external mating threads (tank valve marked "USE WITH TYPE 1").
- Inspect the hose shipped with the appliance for any damage. Do not use if there is evidence of damage.
- Connect the end of the hose onto the ON/OFF gas valve of the appliance. Make sure it is secured tightly.
- Connect the regulator assembly to the tank valve. Hand-tighten only (clockwise). Do not use a wrench to tighten! Use of a wrench may damage the quick closing nut and result in a hazardous condition.
- Position the hose out of pathways where people might trip over it or in areas where the hose might be subject to accidental damage.

**DO NOT BURN WITHOUT GLASS OR
OTHER SUBSTRATE SUCH AS LAVA
ROCK IN BURNER.**

C. Igniter Installation and Grounding

Note: Before installing ignition system, ensure that gas valves are closed and gas is disconnected for safety.

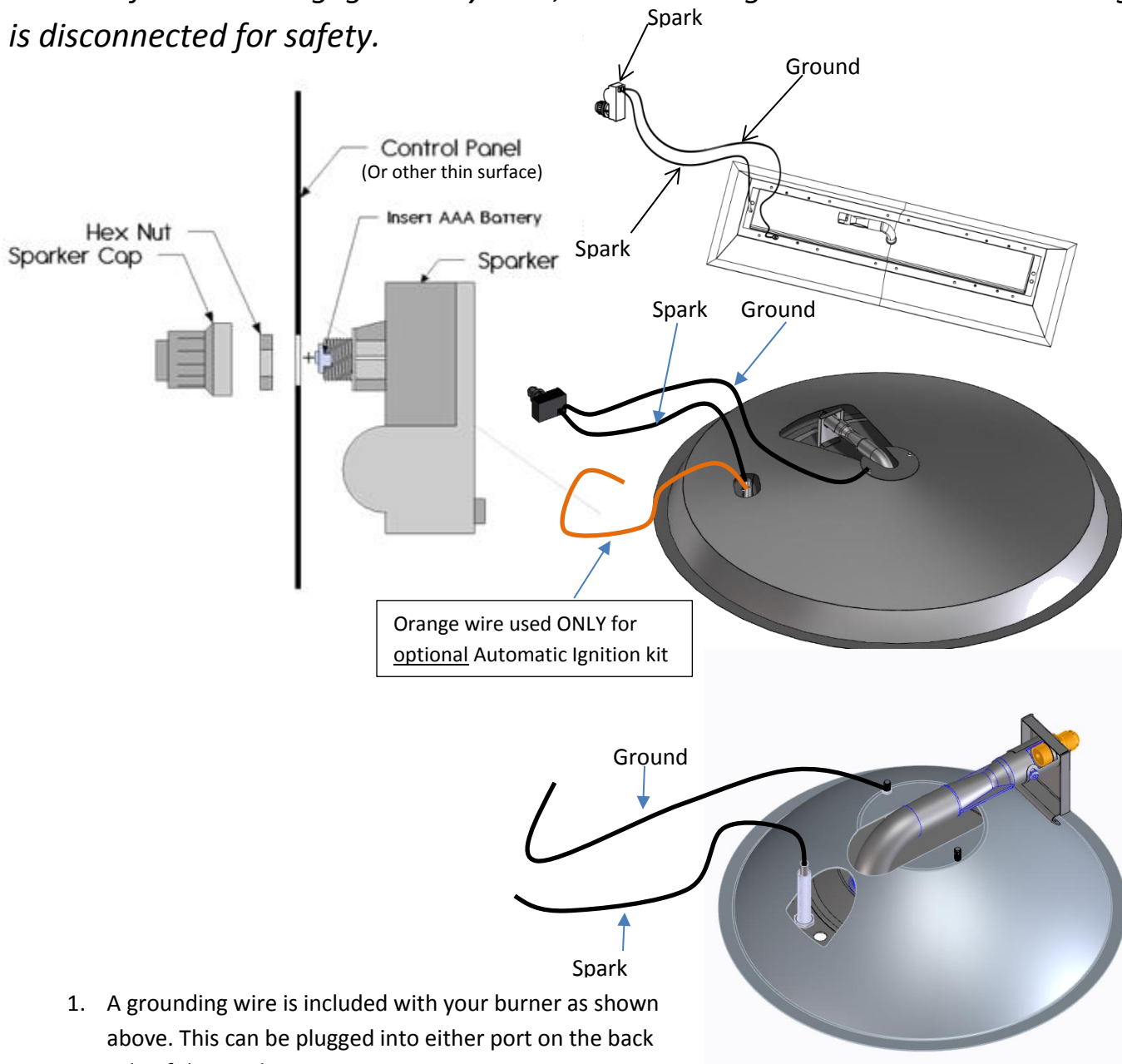

1. A grounding wire is included with your burner as shown above. This can be plugged into either port on the back side of the sparker.
2. A spark wire hangs from the electrode at the end of the burner (also above). This can be plugged into the remaining open port on the back side of the sparker to complete igniter hookup.

Note: It doesn't make a difference which port the wires are plugged into, as long as they are both plugged in.

A battery (AAA type) should be installed in the igniter before use. The battery's positive end (+) should face outward when installed.

A. Fuel

Before making gas connections, ensure the appliance being installed is compatible with the available gas type.

B. Gas Pressure

Proper input pressures are required for optimum performance. Gas line sizing requirements need to be made following NFPA54

WARNING

Fire Risk
Explosion Risk

Verify inlet pressures.

- High pressure may cause overfire condition.
- Low pressure may cause explosion.
- Verify minimum pressures when other household gas appliances are operating

Install regulator upstream of valve if line pressure is greater than ½ psig.

Pressure requirements for appliance are shown in table below. Minimum pressures must be met when other household gas appliances are operating.

Pressure	Natural Gas	Propane
Minimum Inlet Pressure	7 in w.c.	11 in. w.c.
Maximum Inlet Pressure	10.5 in w.c.	14 in. w.c.

The appliance and its individual shutoff valve must be disconnected from the gas supply piping system during any pressures in excess of 1/2 psi (3.5 kPa).

The appliance must be isolated from the gas supply piping system by closing its individual manual shutoff valve during any pressure testing of the gas supply piping system at test pressures equal to or less than 1/2 psi (3.5 kPa).

C. Gas Connection

Note: Have the gas supply installed in accordance with local building codes, if any. If not, follow ANSI 223.1. Installation should be done by a qualified installer approved and/or licensed as required by the locality. (In the Commonwealth of Massachusetts installation must be performed by a licensed plumber or gas fitter.

Note: A listed (and Commonwealth of Massachusetts approved) 3/8 in. T-handle manual shut-off valve and flexible gas connector are connected to the 3/8 in. control valve inlet.

If substituting for these components, please consult local codes for compliance.

Incoming gas line should be piped to the 3/8 inch connection on the manual shutoff valve.

WARNING

Fire Risk
Explosion Risk

- Gas build-up during line purge may ignite.
- Purge should be performed by qualified technician.
- Ensure adequate ventilation.
- Ensure there are no ignition sources such as sparks or open flames.

- A small amount of air will be in the gas supply lines. When first lighting appliance it will take a short time for air to purge from lines. Subsequent lighting of the unit will not require such purging. **Never allow the ON/OFF valve to remain in the open position without pressing and continuing to hold igniter button FIRST.**

WARNING

CHECK FOR GAS LEAKS

Fire Risk
Explosion Risk
Asphyxiation Risk

- Check all fittings and connections.
- Do not use open flame.
- After the gas line installation is complete, all connections must be tightened and checked for leaks with a commercially available leak-check solution. Be sure to rinse off all leak check solution following testing.

Fittings and connections may have loosened during shipping and handling

D.LP Gas Supply

- The pressure regulator and hose assembly supplied with LP models must be used. Replacement pressure regulators and hose assemblies must be those specified in this manual.
- The LP gas supply cylinder used with LP models must be constructed and marked in accordance with the specifications for LP gas cylinders of the U.S. Department of Transportation (DOT).
- Cylinders must be stored outdoors in a well ventilated area out of the reach of children. Disconnected cylinders must have threaded valve plugs tightly installed and must not be stored in a building, garage or any other enclosed area.
- Storage of this appliance indoors is permissible only if it has been disconnected from its fuel supply (natural gas line or LP gas cylinder).
- The LP gas cylinder supply system must be arranged for vapor withdrawal.
- The LP gas cylinder used must include a collar to protect the cylinder valve.
- When an LP model is not in use, the LP gas must be turned off at the supply cylinder.
- The specific size and capacity of the cylinder(s) to be used: 20 lb. or hard plumbed to propane tank.

IMPROPER INSTALLATION, ADJUSTMENT, ALTERATION SERVICES, OR MAINTENANCE CAN CAUSE INJURY OR PROPERTY DAMAGE. REFER TO AND UNDERSTAND THIS MANUAL. FOR ASSISTANCE OR ADDITIONAL INFORMATION CONSULT A QUALIFIED INSTALLER, SERVICE AGENCY, LICENSED TECHNICIAN OR THE GAS SUPPLIER.

Gas Setup for Liquid Propane

1. With burner in place in Outdoor GreatRoom Company fire pit table or other installation location and proper sized orifice inserted in burner neck (see chart on p.4 for orifice sizing), locate flexible rubber propane hose and regulator supplied with this burner.
2. Attach the propane hose to incoming gas fitting on the gas valve. For Outdoor GreatRoom Company gas valves and control panels, this is the lower fitting. Using two wrenches, one to hold the valve and one to turn the valve fitting. Tighten securely. If not using this type of valve, the included ball valve can be used as shown at right.
3. Locate the metal flex-line gas hose and tighten securely to the top valve fitting following the method described in step 2.
4. **Using two wrenches**, securely tighten the flare nut on the free end of the metal flex hose to the orifice on the burner.
5. **For liquid propane installations, the air shutter may be left open as shown at right to prevent sooting.** To adjust air shutter, loosen the small securing screw and rotate air shutter to allow more or less airflow. Closing the shutter will produce a more yellow flame but may soot.

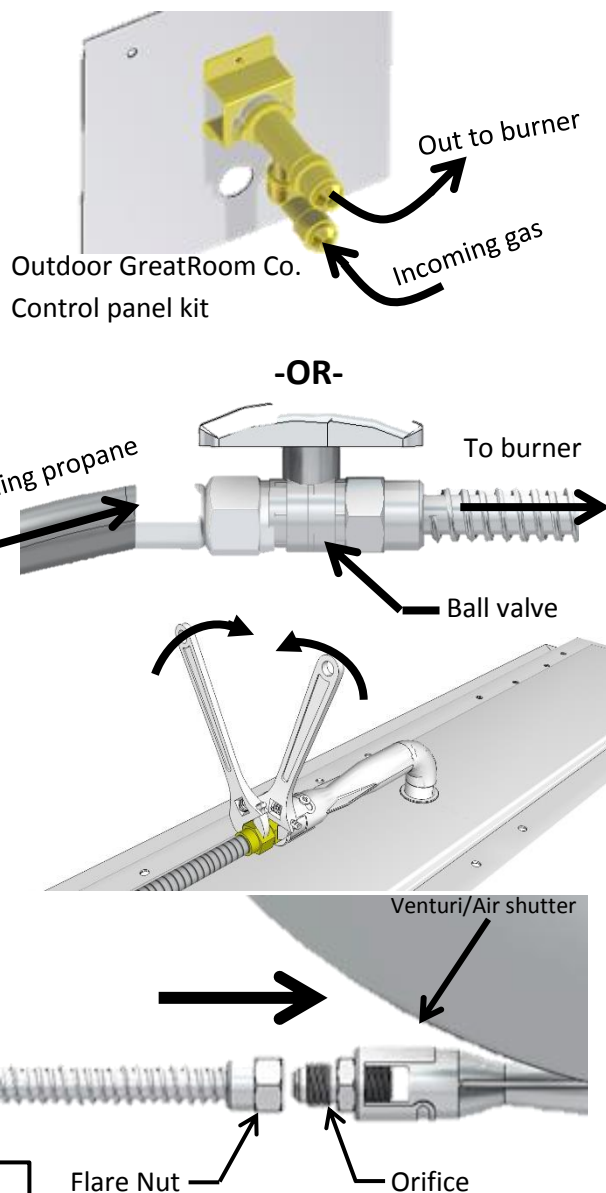

CHECK ENTIRE SYSTEM FOR LEAKS BEFORE OPERATING

Gas Setup for Natural Gas

1. With burner in place in Outdoor GreatRoom Company fire pit table or other installation location and proper sized orifice inserted in burner neck (see chart on p.4 for natural gas orifice sizing), adjust air shutter to a closed position (as shown at right, no light visible through the shutter) by loosening the small screw on the air shutter and rotating it to a closed position and re-tightening screw.
2. Locate the included metal flex-line hose and thread one end onto orifice and tighten securely with two wrenches.
3. At this point you have two options for plumbing natural gas. If using a valve assembly such as The Outdoor GreatRoom Company's valve kit, proceed to step 3a. If plumbing directly to a natural gas line proceed to 3b.
 - a. Attach the free end of flex hose to the top (outgoing) flare fitting of control valve and tighten fully with two wrenches. Plumb incoming natural gas to the incoming side of the valve using a 3/8" flare nut. It is strongly recommended that a manual shutoff valve is placed in the natural gas line **before** it reaches the fire pit's control valve.
 - b. Thread the included ball valve onto the free end of the metal flex line and plumb incoming natural gas line to the ball valve with a 3/8" flare nut.

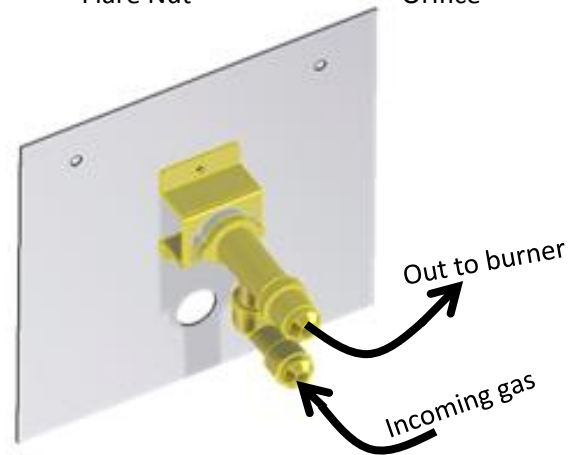
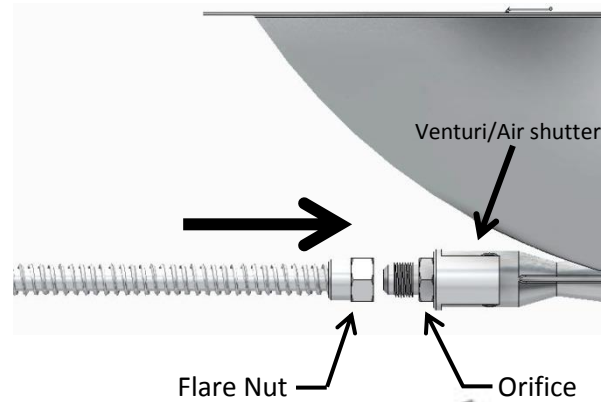

Outdoor GreatRoom Co. Control panel kit

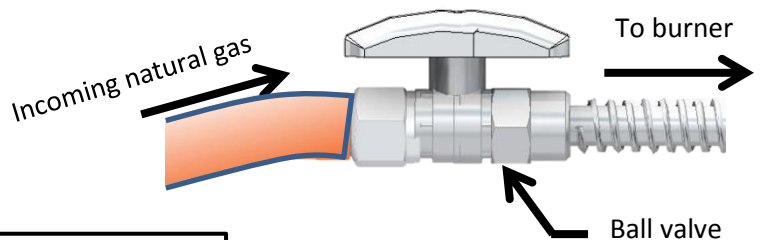

CHECK ENTIRE SYSTEM FOR LEAKS BEFORE OPERATING

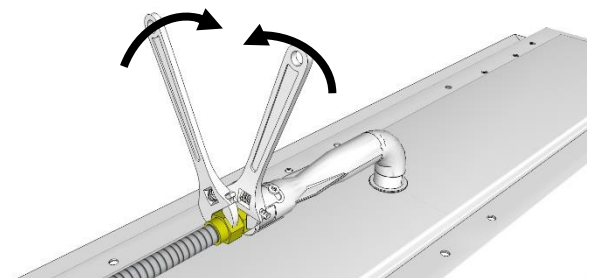

6 Lighting and Operation

FOR YOUR SAFETY, READ BEFORE LIGHTING

WARNING!

If you do not follow these instructions exactly, a fire or explosion may result causing property damage, personal injury, and/or loss of life.

- A. This appliance can be lit electronically or with a match. When lighting, follow these instructions exactly.
- B. **Before lighting**, smell all around the appliance area for gas. Be sure to smell next to the base of the appliance because some gas is heavier than air and will settle on the floor.

WHAT TO DO IF YOU SMELL GAS:

- Do not try to light any appliance.
- Do not touch any electric switch, do not use any phone nearby.
- Immediately call your gas supplier from a neighbors phone. Follow gas supplier's instructions.
- If you cannot reach your gas supplier, call the fire department

C. Use only your hand to turn the gas control knob on propane tank (if equipped), never use tools. If the valve won't turn by hand, don't try to repair it, call a qualified service technician. Force or attempted repair may result in a fire or explosion.

D. Do not use the appliance if any part has been underwater. Immediately call a qualified service technician to inspect the appliance and replace any part which has been underwater.

E. The gas pressure regulator provided with this appliance must be used. This regulator is set for an outlet pressure of 10.5 inches water column.

Lighting Instructions

1. Depress button on igniter and verify a spark is being produced between the electrode tip and receiving probe.
2. Ensure control panel valve is in the "OFF" position and slowly open valve on propane tank. If using natural gas or whole-house LP, open ball valve. If not using a control valve, skip this procedure until step 3.
3. Depress igniter button and continue holding button while turning control valve (or ball valve if not using a control knob valve) to the on position. Release button once flame is present.

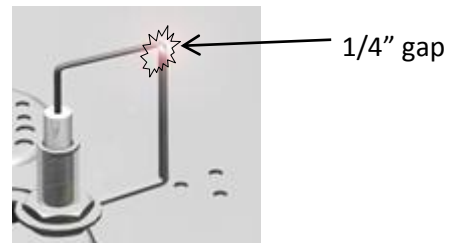

To Extinguish: Turn control valve to "OFF" position or close ball valve. Close valve on propane tank while not in use.

Initial break-in procedure: When you light the appliance, you may notice that it produces heat which may have an odor. If you feel this odor is excessive it may require an initial three to four hour continuous burn on high.



WARNING



FIRE RISK – HIGH TEMPERATURES

Keep combustible household items away from appliance.

- Do NOT obstruct combustion and ventilation air.
- Do NOT place combustible items on top of or near appliance.
- Keep furniture, draperies away from appliance.
- Do NOT use, lantern fuel, kerosene, charcoal lighter fluid, or similar liquids in this appliance.
- Combustible materials, flammable liquids, or vapors may ignite.

Symptom		Possible Causes		Corrective Actions
1.	Crystal Fire won't light.	A.	No LP in tank, or NG main not turned on.	Check the LP (propane) tank. You may be out of gas. Or check Natural Gas valve at main.
		B.	Plugged burner orifice.	Check the burner orifice for stoppage. Remove stoppage.
2.	Low flames or won't stay lit.	A.	Manual shutoff valve (on/off control knob) open or not installed between LP tank and appliance.	Close LP tank and manual shutoff valves. Open LP tank valve first, THEN the manual shutoff valve.
3.	Blue Flames	A.	This is a result of normal operation and flames will begin to yellow as unit is allowed to burn for 16-20 minutes.	Do nothing.
		B.	Improper air/fuel mixture related to air shutter position.	Close air shutter. (for LP, leave ¼" open, Natural gas 1/16" open)
4.	Metallic noise	A.	Noise is caused by metal expanding and contracting as it heats up and cools down, similar to the sound produced by a furnace or heating duct. This noise does not affect the operation or longevity of the appliance.	Do nothing.
5.	Decorative Beads cracking or splitting	A.	Heat and/or abrupt temperature changes.	This is a property of glass and may happen occasionally. Do nothing. This is completely normal.
6.	Sparker makes clicking sound but no visible spark is produced	A.	Sparker is improperly grounded	Refer to section 4-C on Page 9 for grounding instructions. Check all wire connections.
		B.	Ignition or ground wire not plugged in.	
		C.	Igniter tip set too far from grounding probe	Check that tip of sparker is within ¼" of grounding probe. Gently bend igniter tip or grounding probe by hand to achieve a smaller gap.
7.	Sparker does not spark or make a ticking sound	A.	Battery low, Not installed, Installed incorrectly	Ensure that a fresh AAA battery is installed Positive (+) side facing outward toward the sparker cap.
		B.	Corrosion on battery contacts	Check contact at the bottom of the battery cavity for corrosion. Clean with a small piece of sandpaper or a file
		C.	Battery cap not screwed down completely	If the cap cannot be screwed down tight enough, the battery will not make a proper connection with the sparker and it will not work. Be sure to use a thin surface such as 20-22gauge sheet metal to mount sparker in.

9

Service and Maintenance

Although the frequency of appliance servicing and maintenance will depend on use and the type of installation, a qualified service technician should perform an appliance check-up annual.

Storage of an appliance indoors is permissible only if the cylinder is disconnected and removed from the appliance.

The use of a vinyl table cover is highly recommended to keep your table and burner looking new and ensuring extended trouble-free operation.

WARNING

Risk of injury or property damage

Before servicing:

- Turn off utilities to appliance.
- Ensure appliance is completely cooled.

WARNING



Annual inspection by qualified technician recommended.

Check:

- Obstructions of combustion and ventilation air.
- Condition of burner assembly.
- Burner ignition and operation.
- Burner air shutter adjustment.
- Gas connections and fittings.



Risk of:

- Fire
- Delayed ignition or explosion
- Exposure to combustion fumes
- Odors



Maintenance and Service Tasks

For service calls: Contact the dealer your product was purchased from first.
Contact the Outdoor GreatRoom Company at 1-866-303-4028 if further assistance is needed.

Inspect	Maintenance Tasks	
Burner Assembly	1	Remove decorative glass and examine burner. Vacuum and wipe out as needed. Use caution when cleaning these areas
	2	Inspect for warping and corrosion. Repair as necessary
	3	Check the hose connecting the LP gas cylinder to ensure it is not damaged. Replace as necessary.
	4	Verify air shutter area is clean
Burner Ignition and Operation	1	Verify all gas connections are tight and leak-free
	2	Clean burner top, inspect for plugged ports, corrosion, or deterioration. Replace burner if necessary.
	3	Inspect for flame problems.
	4	Verify air shutter is clear of dust and debris and is in correct position for the gas type being used.
	5	Inspect orifice for soot, dirt, or corrosion
	6	Verify manifold and inlet pressures. Adjust regulator as required.
Gas Hose with Regulator	1	The gas hose with regulator supplied with appliance must be used for LP installations. The replacement must be those specified by the appliance manufacturer

A. Service Parts List

#	Description of Part	Part Number	Qty.
1	Burner Assembly	SRV-BA-CF 20/1224/2424/1242	1
2	Flex Tube	SRV-FT-CF	1
3	Orifice – NG/LP (#31) For CF-20(NG), CF-1224 (NG), CF-1242(whole-house LP)	NGK-CF	1
4	Orifice – NG (#17) For CF-2424	NGK-17	1
5	Orifice – LP (#36)	LPK-36	1
6	Orifice – NG(#21)	NGK-21	1
7	Orifice – LP (#43) For CF-1242 and CF-2424 (LP- 20lb tank) ,CF-20 (LP), CF-1224(LP)	LPK-43	1
9	Red-handled replacement ball valve	SRV-BV-CF	1
10	Control panel for DIY or Outdoor GreatRoom Co. fire pit tables	CT-Control Panel	1
11	Electronic Piezo	CF-Sparker	1
12	Gas Hose with Regulator	SRV-Hose-CF	1
13	Ignition Electrode CF-20/CF-1224/CF-2424/CF-1242	CF-Electrode CF-20/CF-1224/CF-2424/CF-1242	1
14	Replacement Glass for Crystal Fire (4lb bag)	CF20-Glass	1
15	CF20 Log Set	CF20-Logs	1
16	Grounding wire for Crystal Fires (All models)	SPK-GND	1

C. Limited One Year Warranty



THE OUTDOOR
GREATROOM
COMPANY

The Outdoor GreatRoom Company Outdoor Products Limited Warranty

The Outdoor GreatRoom Company extends the following warranty for Outdoor GreatRoom outdoor products used in the United States of America or Canada. Dealers and employees of The Outdoor GreatRoom Company have no authority to make any warranty or authorize any remedies in addition to or inconsistent with the terms of this warranty. This warranty gives you specific legal rights. You may also have other rights that vary from state to state.

The Outdoor GreatRoom Company warrants that this Outdoor GreatRoom Outdoor Product (the "Product") will be free from defects in material and workmanship for a period of one year from its date of purchase. Stainless steel parts and assemblies carry a limited lifetime warranty. This warranty is subject to the conditions, exclusions and limitations described below.

This warranty applies only to the original owner of the Product and is non-transferable. The Outdoor GreatRoom Company obligation under this warranty does not extend to damages resulting from (1) assembly, operation or maintenance of the Product not in accordance with the Installation/Assembly Instructions, Operating Instructions and the Listing Agency Identification Label furnished with the Product; (2) installation or use which does not comply with local building codes and ordinances; (3) shipping, improper handling, improper operation, abuse, misuse, accident or unworkmanlike repairs; (4) use of fuels other than those specified in the Operating Instructions; (5) Installation or use of components not supplied with the Product or any other components not expressly authorized and approved in writing by The Outdoor GreatRoom Company; and/or (6) modification of the Product not expressly authorized and approved in writing by The Outdoor GreatRoom Company. Any of the circumstances described in the previous sentence voids this warranty. This warranty is void if the Product or any component has been removed, repaired, or replaced before The Outdoor GreatRoom Company has been afforded a reasonable opportunity to inspect the Product.

This warranty is limited to the replacement or repair of defective components or workmanship and The Outdoor GreatRoom Company may fully discharge its obligations under this warranty by repairing or replacing, at its discretion, the defective components. The Outdoor GreatRoom Company will provide replacement parts at no charge and will pay reasonable and necessary labor and freight costs related to replacing or repairing defective components under this warranty. The maximum amount recoverable under this warranty is limited to the purchase price of the Product and, if The Outdoor GreatRoom Company is unable to provide replacement or repair in an expedient and cost-effective manner, The Outdoor GreatRoom Company may discharge all obligations under this warranty by refunding the purchase price of the Product.

EXCEPT TO THE EXTENT PROVIDED BY LAW, THE OUTDOOR GREATROOM COMPANY MAKES NO EXPRESS WARRANTIES OTHER THAN THE WARRANTY EXPRESSED HEREIN. THE DURATION OF ANY IMPLIED WARRANTY IS LIMITED TO THE DURATION OF THE WARRANTY SPECIFIED ABOVE. IN NO EVENT SHALL THE OUTDOOR GREATROOM COMPANY BE LIABLE FOR ANY INCIDENTAL OR CONSEQUENTIAL DAMAGES CAUSED BY DEFECTS IN THE PRODUCT. Some states do not allow limitations on how long an implied warranty lasts, or do not allow exclusion or limitation of incidental or consequential damages, so these limitations may not apply to you.

To obtain service under this warranty, you must:

1. Send written notice of the claimed condition to: The Outdoor GreatRoom Company, 14400 Southcross Dr. W, Suite 100, Burnsville, MN 55306.
2. Affirm that you are the original owner of the Product.
3. Provide The Outdoor GreatRoom Company reasonable opportunity to investigate the claim, including reasonable opportunity to inspect the Product prior to any repair or replacement work and before the Product or any component of the Product has been removed.