

1.Note:This is not clothing storage cabinet and it is not recommended to use it as a clothing storage cabinet.

2.All cabinets come with TRO,stainless steel or our “L-Bracket”when shipped.

1. Thank you for choosing *our products*.

2. Return Policy







DO NOT RETURN TO THE STORE! Skip the process of returning your product and contact us directly for a replacement

If you find that parts of your order are missing or damaged, we will gladly ship any needed replacement parts free of charge.

If your product's quality does not meet your expectations or you have found any sort of defect, please contact our customer service department and let us know the details of your order and any issues encountered, we will try our best to provide you with a solution. Feel free to also directly contact our manufacturer concerning needed replacement parts and they will be happy to help provide you with a solution or answer any questions you may have.

Recommendations Before Beginning Assembly

-  • Read instructions, cover to cover
-  • Have 2-4 adults on hand for assembly depending on product size
-  • Do not assemble directly on flooring or carpet
-  • Assemble on a clean non-marring surface (example: packing foam)
-  • Save all packaging until finished

3. Assembly Notice:

- If you encounter any problems during assembly and find that you cannot continue, rest assured we will help you solve the situation as soon as possible. Simply keep all of the parts of the product stored in a safe place and contact us immediately so we may assist you further.
- Once you have opened your package, remove all inner hardware packages and take the parts out. One by one, Place the parts out neatly in front of you, then refer to the instructions to ensure no parts are missing. If any pieces are found missing, please carefully look in the box first, as the hardware packaging might have torn making the

hardware spill in the box.

- Some key parts of your product may be stored and hidden inside of other parts. Please open any zippered or hook & loop storage compartments to remove all parts. (example: cushions and legs being stored in the underside of a sofa)
- **IMPORTANT:** When setting up your product, **DO NOT INSTALL THE SCREWS ALL THE WAY IN THE BEGINNING.** Place each screw into their proper hole and use your hand to twist the screw halfway. Twist all the screws in halfway to ensure the holes will match up properly and the product is level on the ground. When everything seems fitted, then tighten the screws.
- When you have completed assembly, we suggest you have more than one person to assist you with lifting and placing the product.

Care & Maintenance

-  Do not put hot items directly on furniture surface
-  Do not clean furniture with harsh cleansers or polish
-  Do not place furniture under direct sunlight
-  Do not place furniture near heating or cooling vents
-  Do not write on furniture without a padded barrier to protect the surface
-  Do not place furniture outside. For indoor use only
-  Not for commercial use. For residential use only
-  Stains may be removed with mild soap solution and damp cloth
-  Children should not climb or jump on the furniture
-  Dust and pick-up spills using a clean, non-colored, lint-free cloth

Caution

- This product contains small components. Please ensure that they are kept away from small children.
- Do not use power tools to assemble your furniture. Power tools may strip or damage the parts.



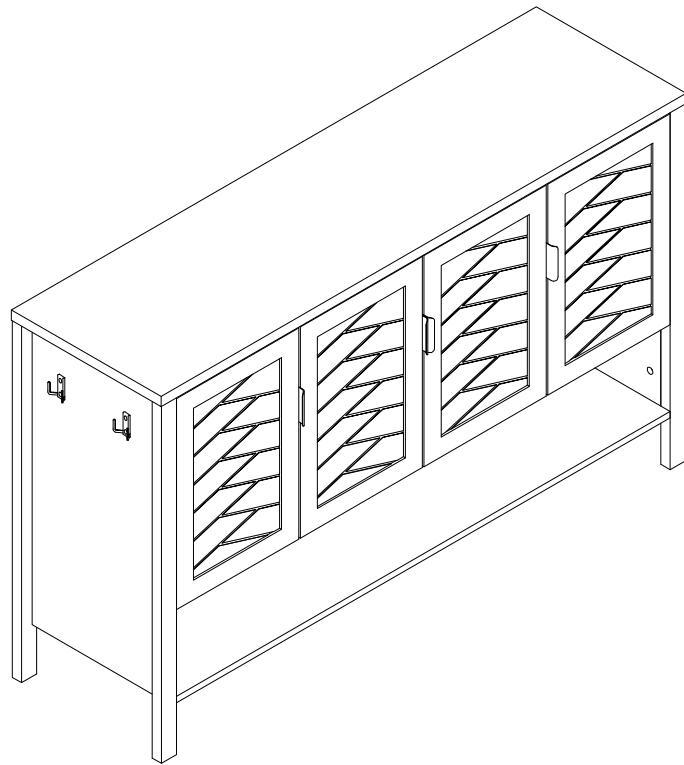

Part List

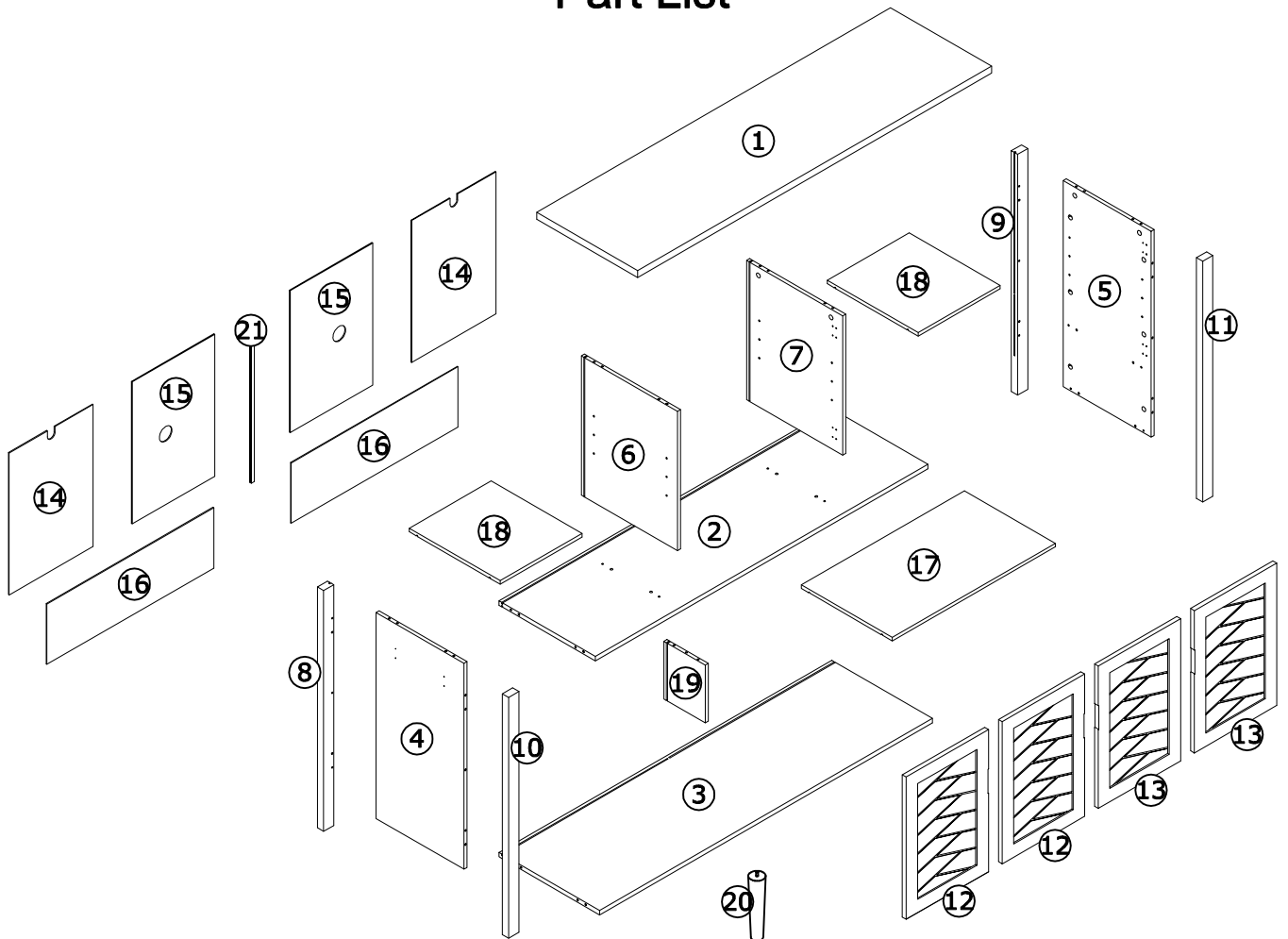

1

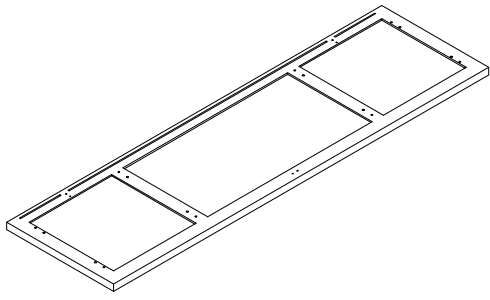

1PC

2

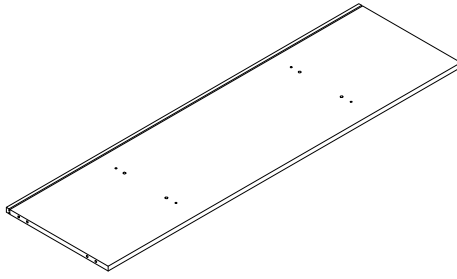

1PC

3

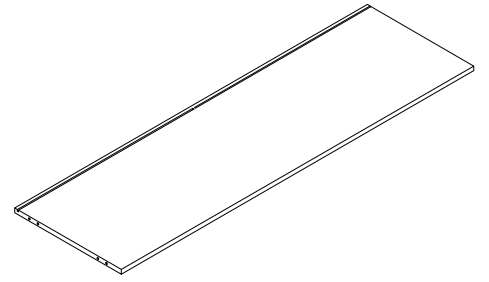

1PC

4

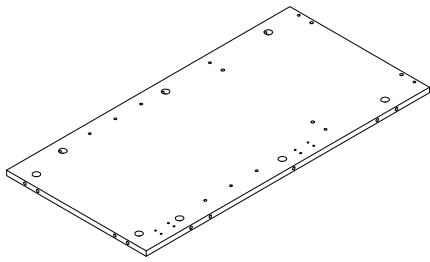

1PC

5

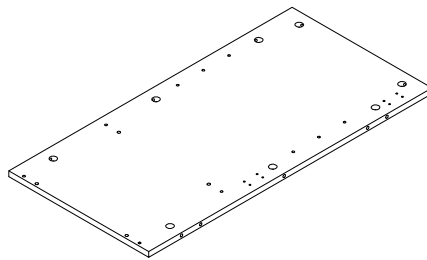

1PC

6

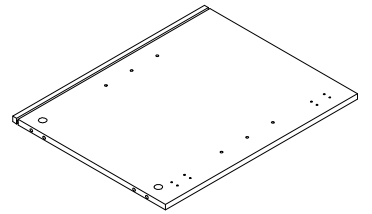

1PC

7

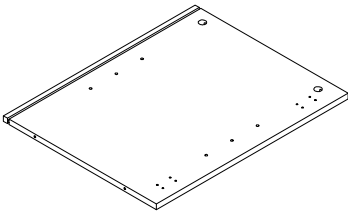

1PC

8

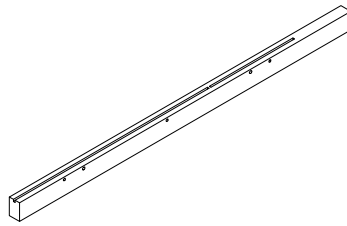

1PC

9

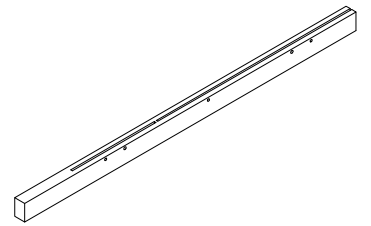

1PC

10

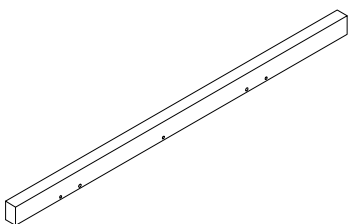

1PC

11

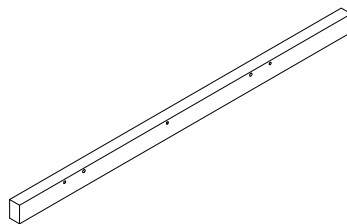

1PC

12

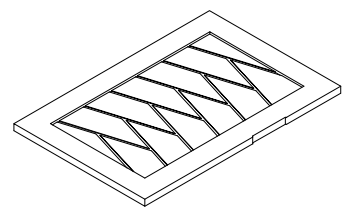

2PCS

13

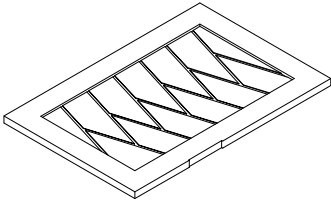

2PCS

14

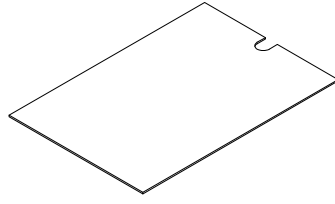

2PCS

15

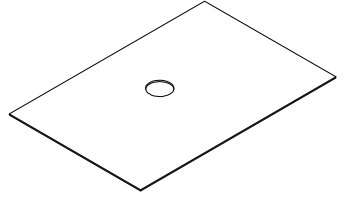

2PCS

16

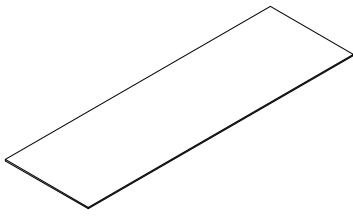

2PCS

17

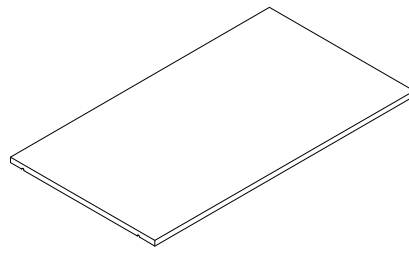

1PC

18

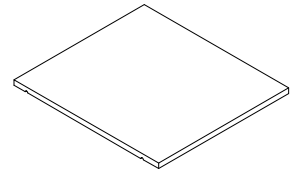

2PCS

19

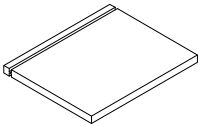

1PC

20







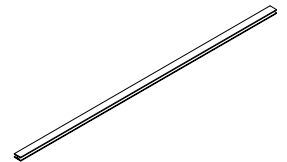

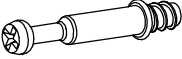

1PC

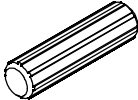
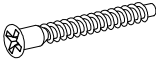
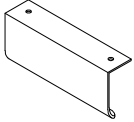
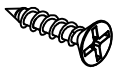
21

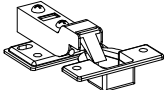
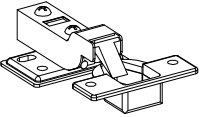
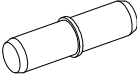
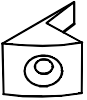
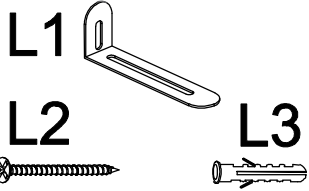

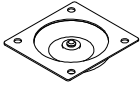
1PC

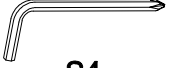
 $\phi 6 \times 35 \text{mm}$	 $\phi 15 \times 9 \text{mm}$	 $\phi 6 \times 30 \text{mm}$	 $M5 \times 40 \text{mm}$
A×30	B×30	C×29	D×6
	 $ST3.5 \times 12 \text{mm}$	 $ST4 \times 16 \text{mm}$	
E×4	F×86	G×2	H×4
			 $\phi 4 \times 40 \text{mm}$
I ×4	J×12	K×20	L×2
		 Plug the hole $\phi 20 \text{mm}$	 S4
M×1	N×1	O×20	P×1

STEP 1

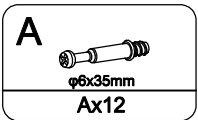
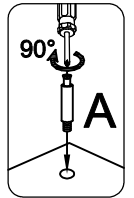
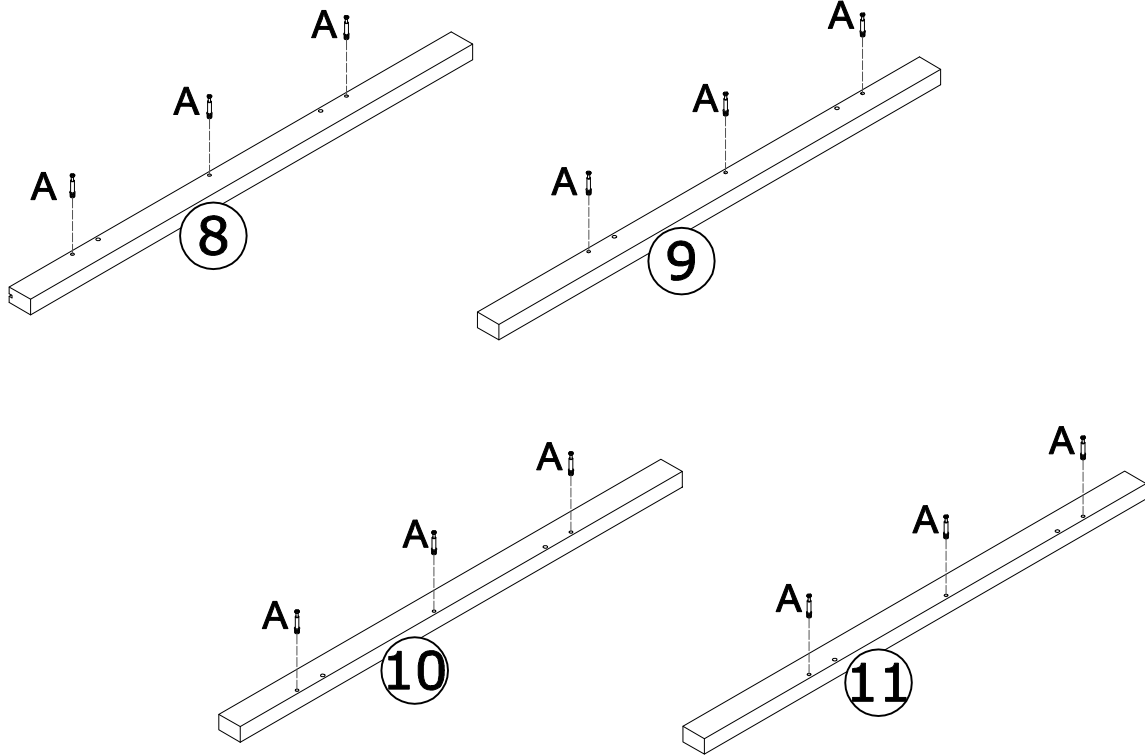



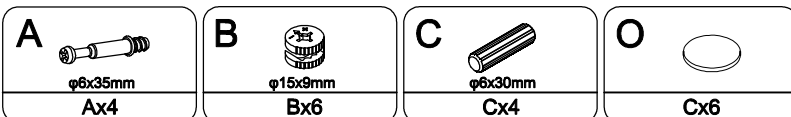
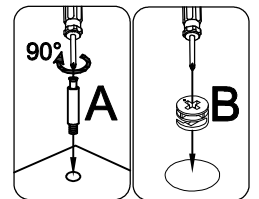
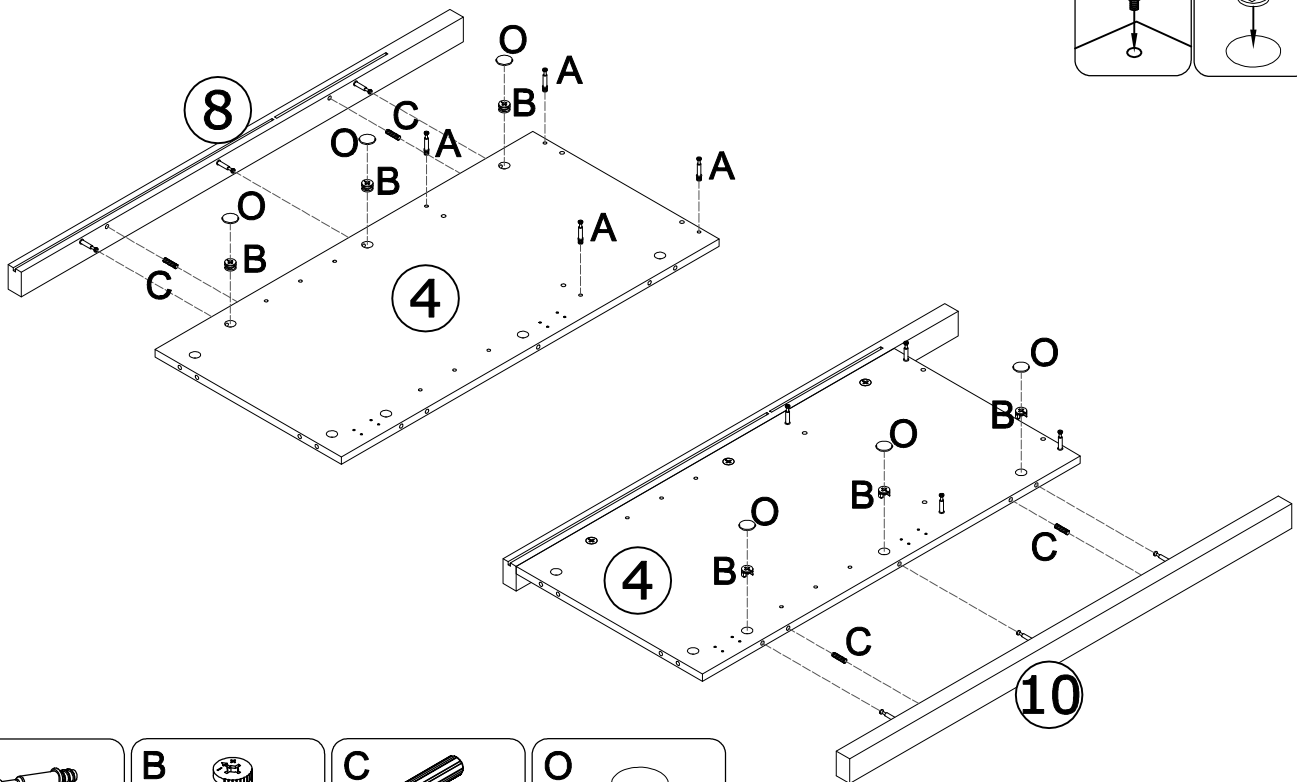

STEP 2

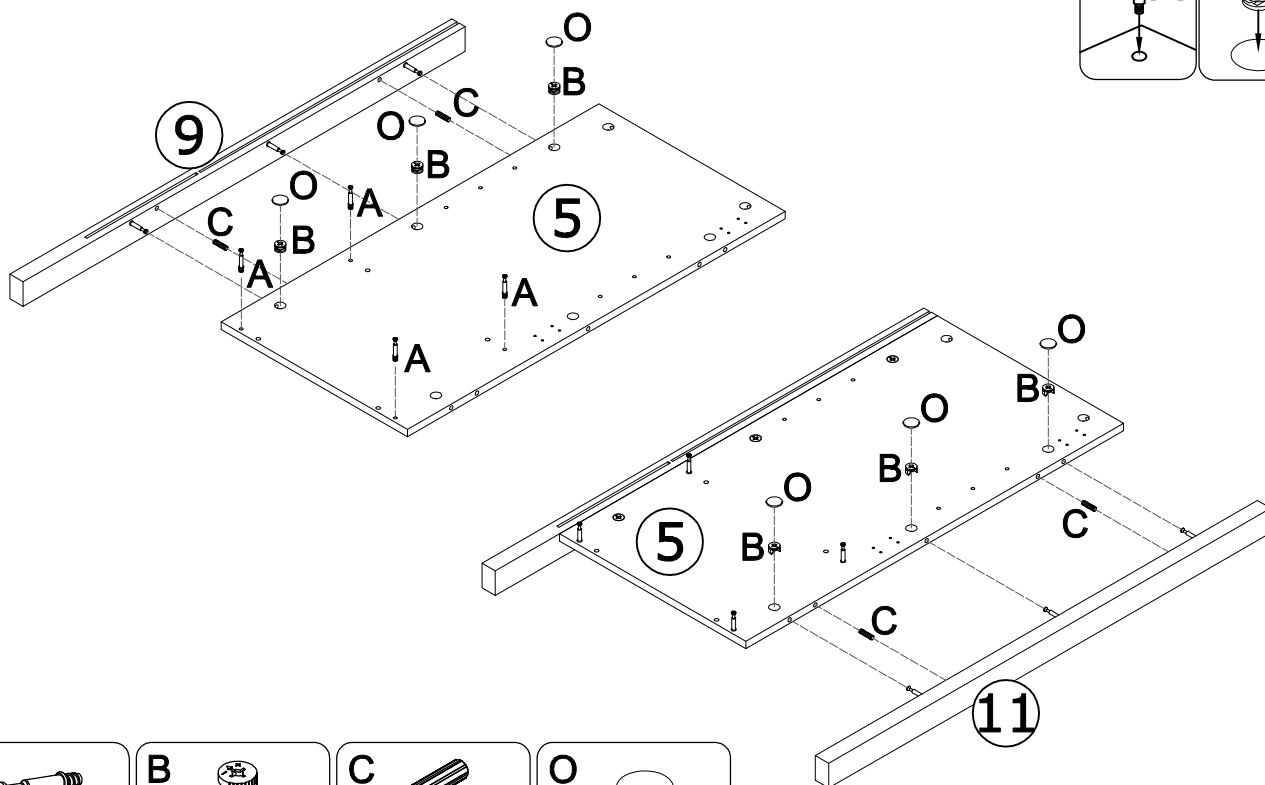
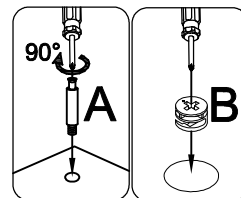



STEP 3

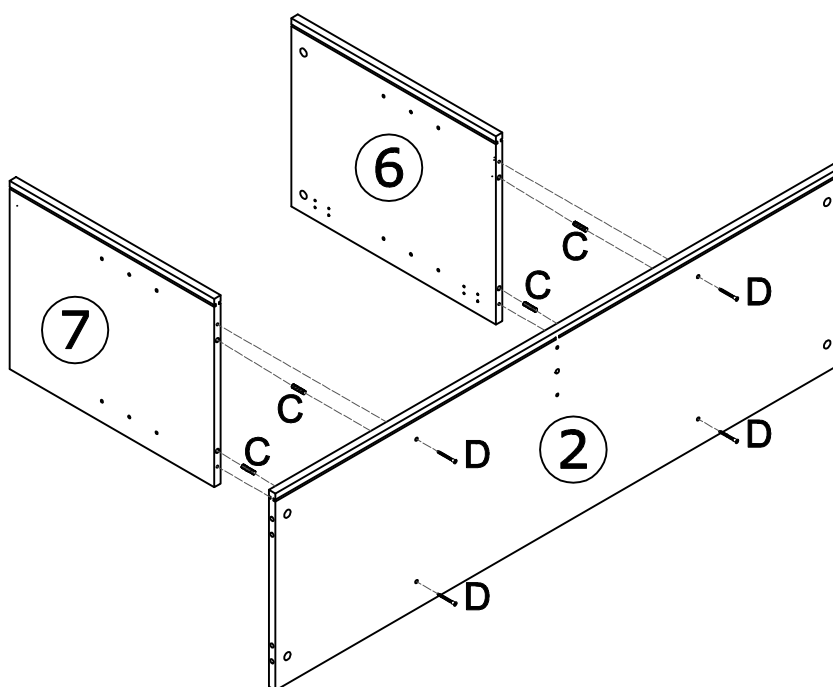
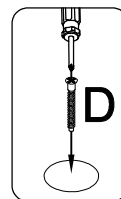

<p>A</p>  <p>φ6x35mm Ax4</p>	<p>B</p>  <p>φ15x9mm Bx6</p>	<p>C</p>  <p>φ6x30mm Cx4</p>	<p>O</p>  <p>Cx6</p>
--	--	--	--

STEP 4



<p>D</p>  <p>M5x40mm Dx4</p>	<p>C</p>  <p>φ6x30mm Cx4</p>
--	--

STEP 5

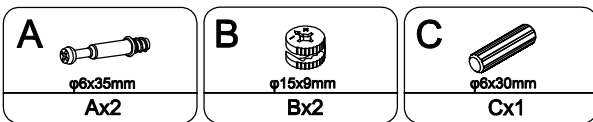
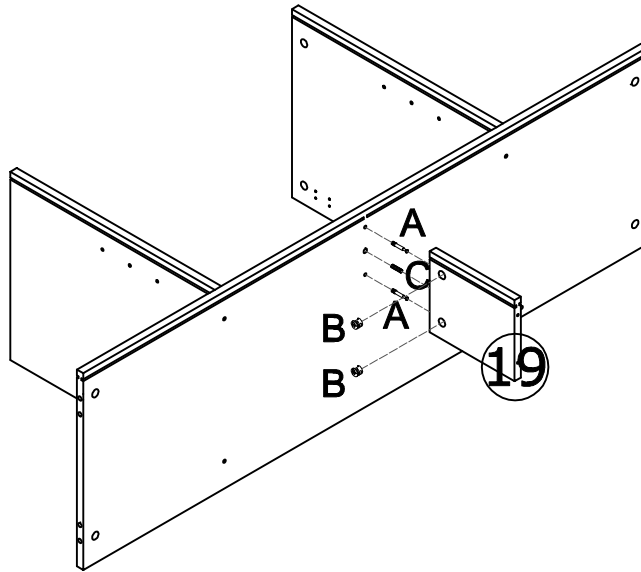
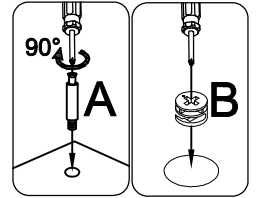

STEP 6

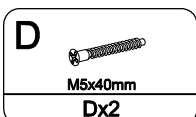
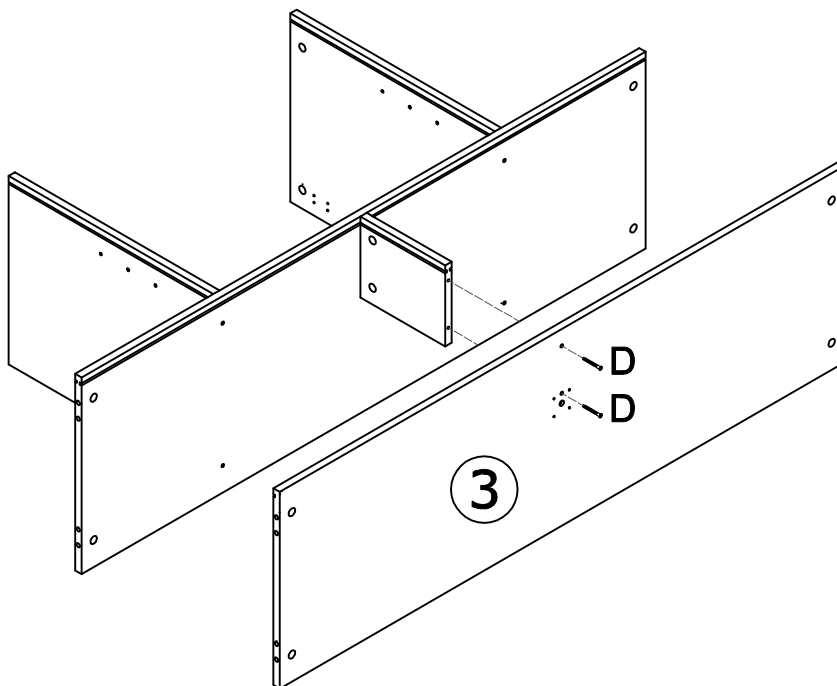
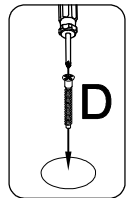



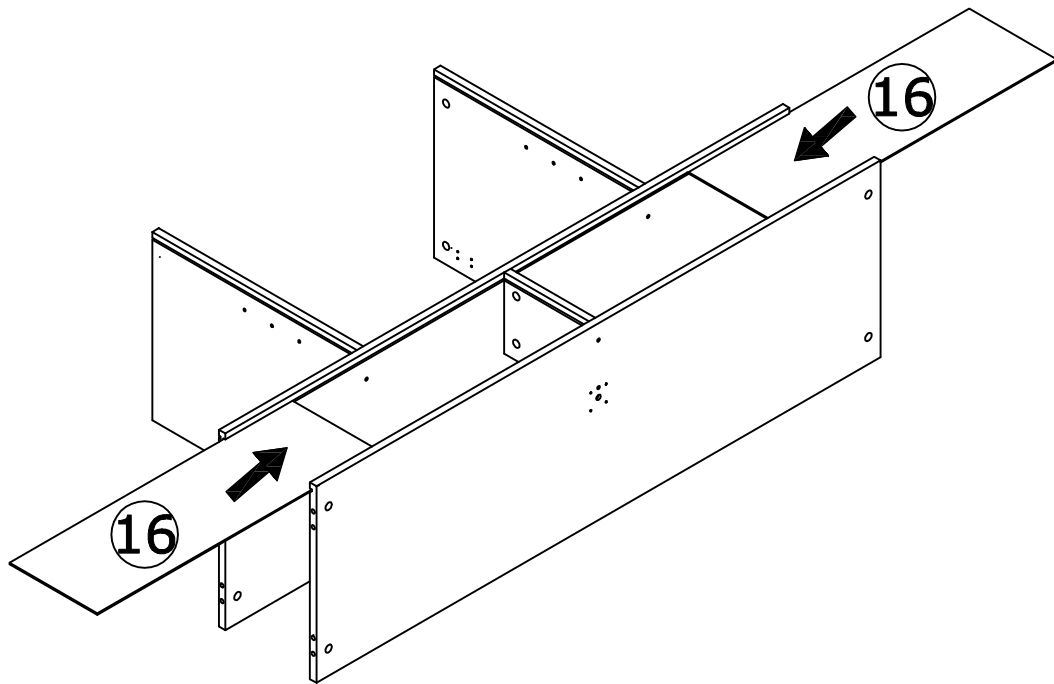

STEP 7

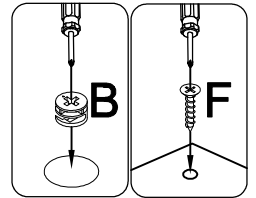
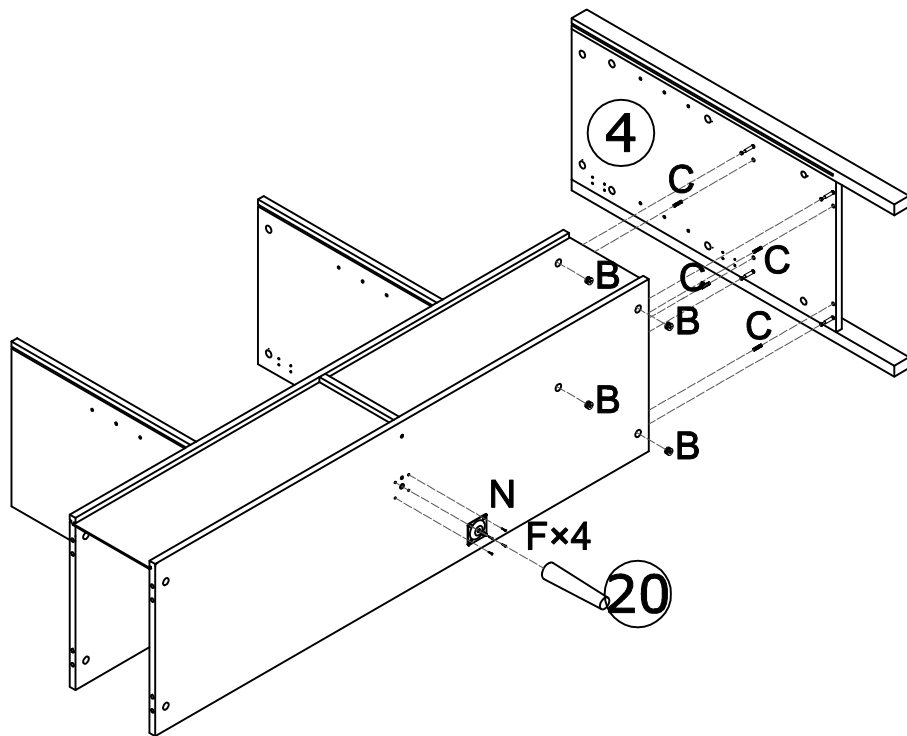

STEP 8



B  φ15x9mm Bx4	C  φ6x30mm Cx4	F  M3.5x12mm Fx4	N  Nx1
---	---	---	--

STEP 9

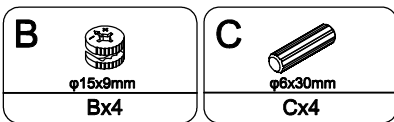
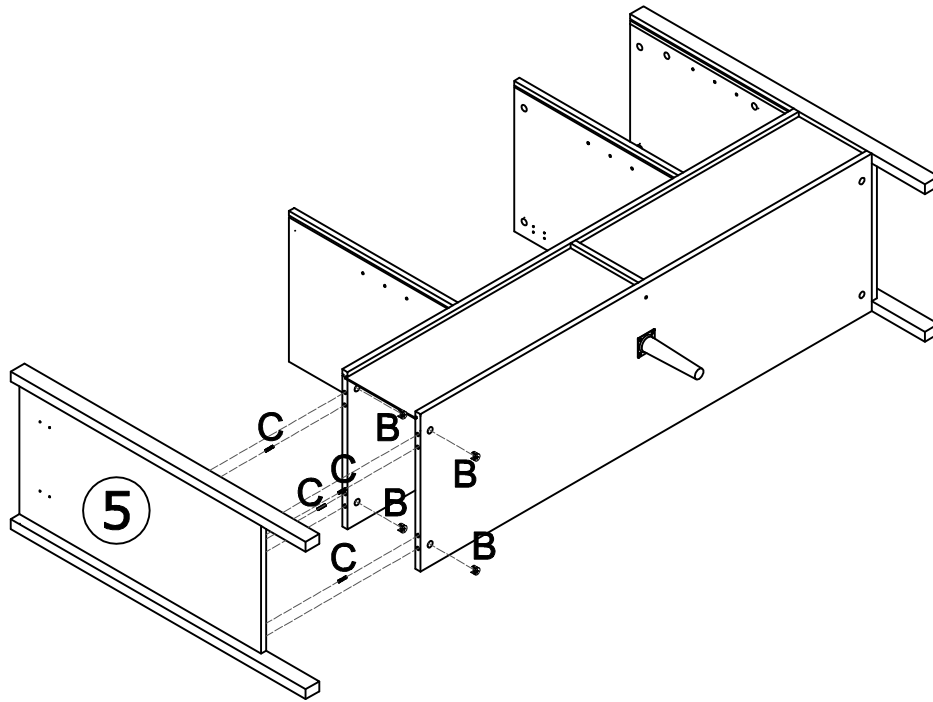
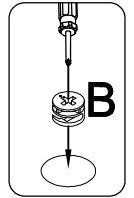



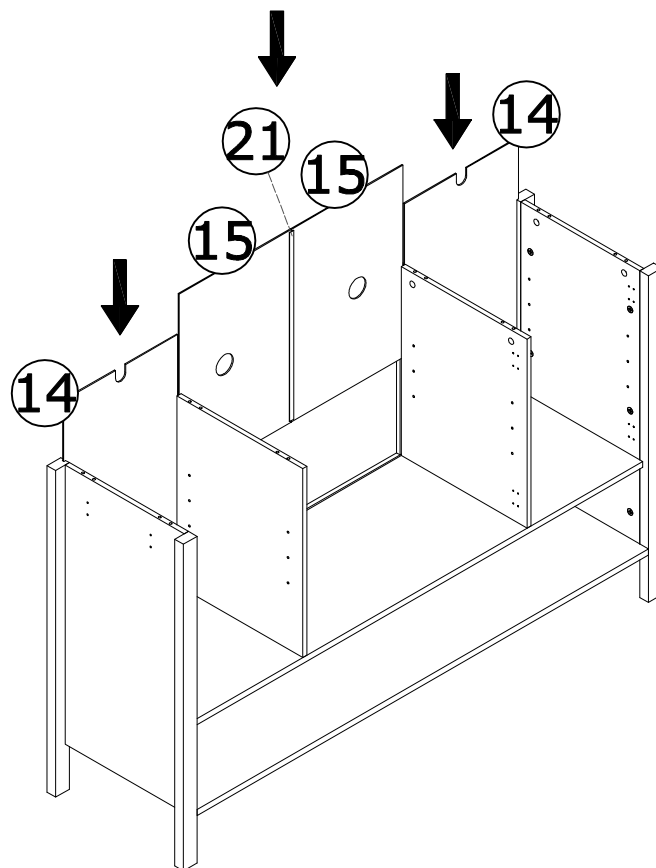

STEP 10

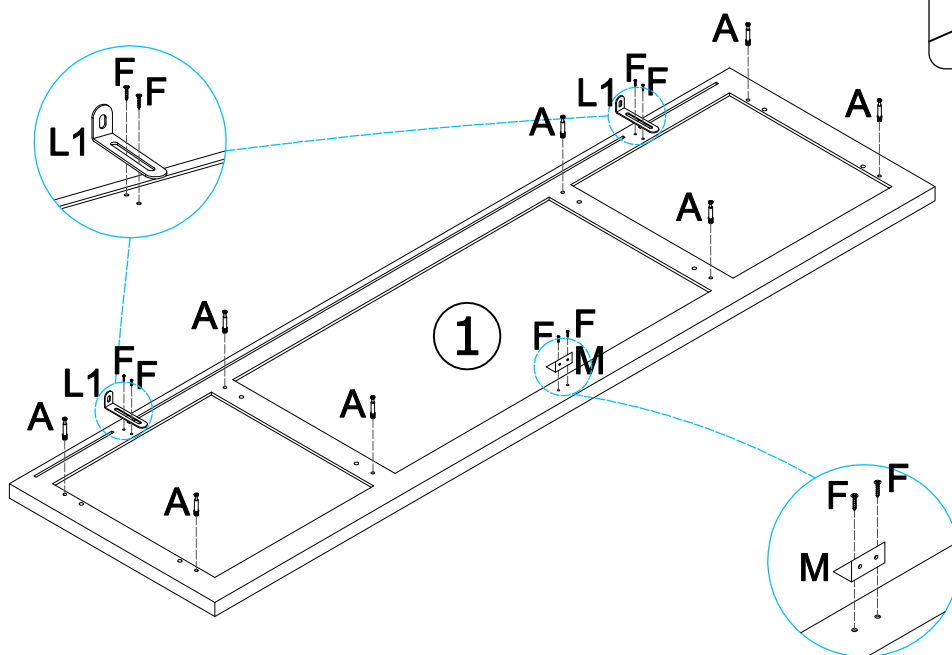
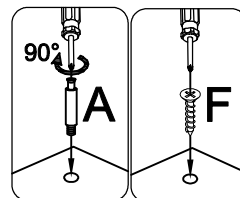





STEP 11

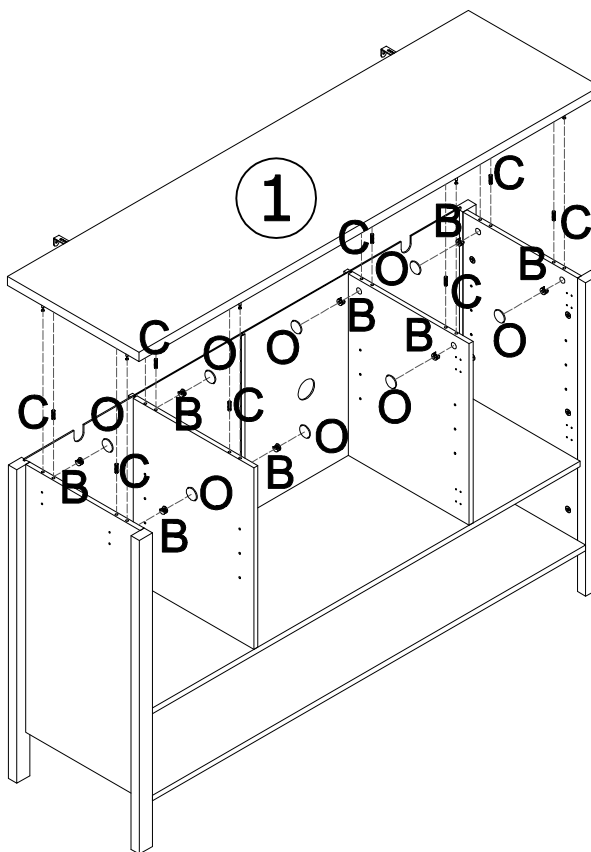
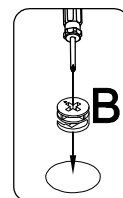

A  φ6x35mm Ax8	F  M3.5x12mm Fx6	M  Mx1	L1  Lx2
---	---	--	---

STEP 12



B  φ15x9mm Bx8	C  φ6x30mm Cx8	O  Cx8
---	---	--

STEP 13

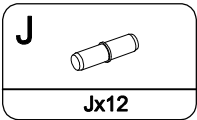
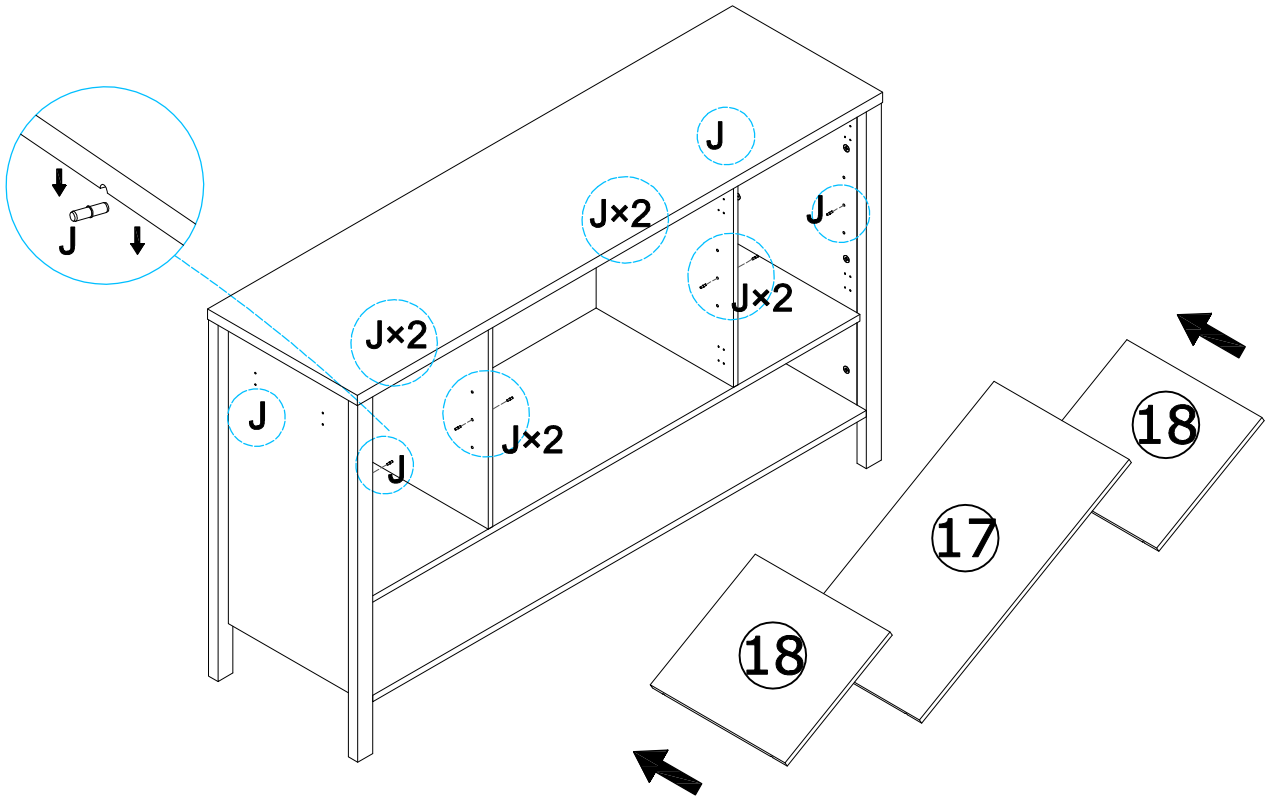

STEP 14

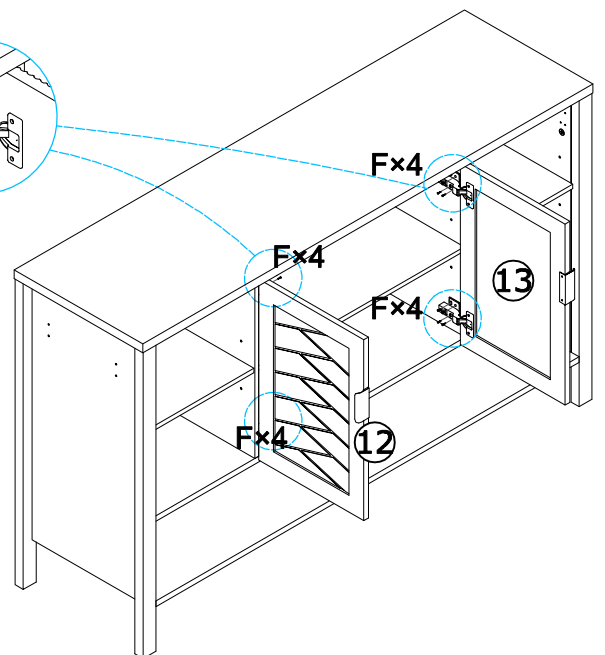
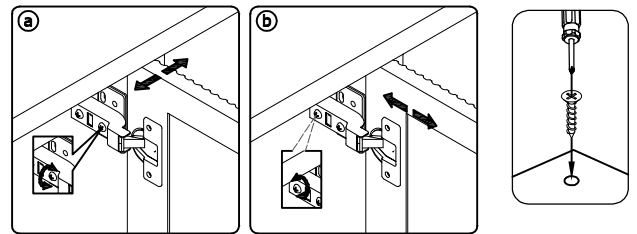
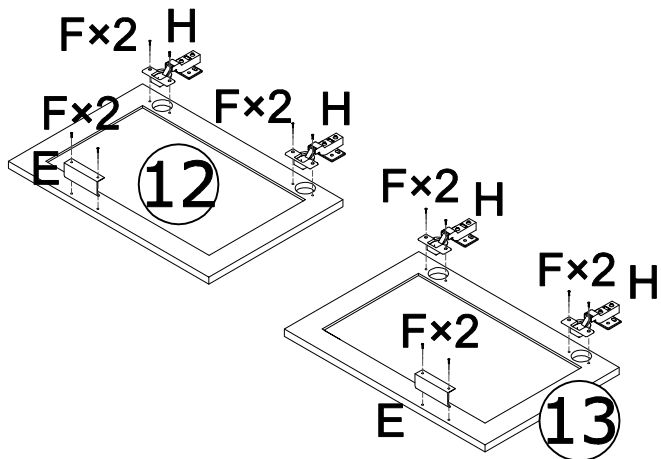

Note: Please assemble the door according to the installation steps first. If the cabinet door is deviated, the internal hinge needs to be slowly adjusted to solve the problem.

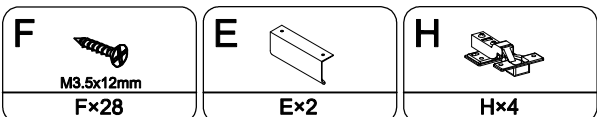

STEP 15

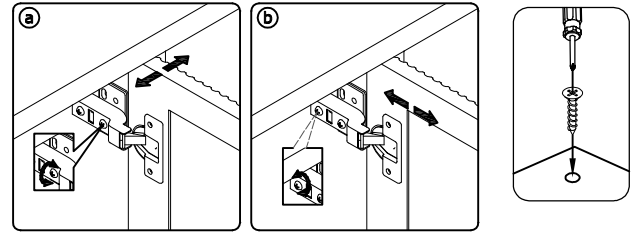
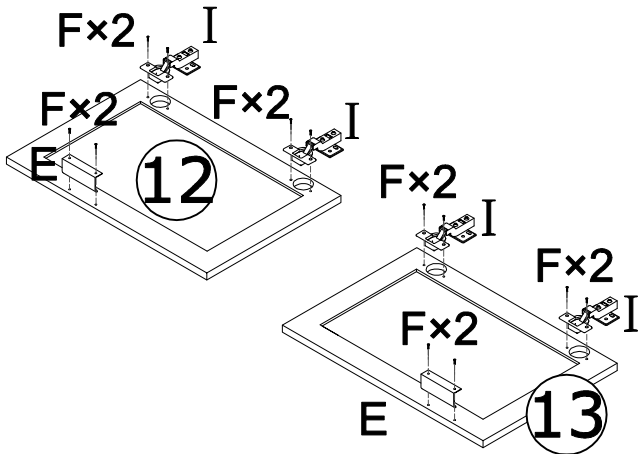

Note: Please assemble the door according to the installation steps first. If the cabinet door is deviated, the internal hinge needs to be slowly adjusted to solve the problem.

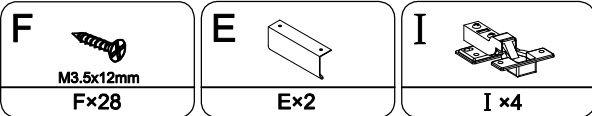
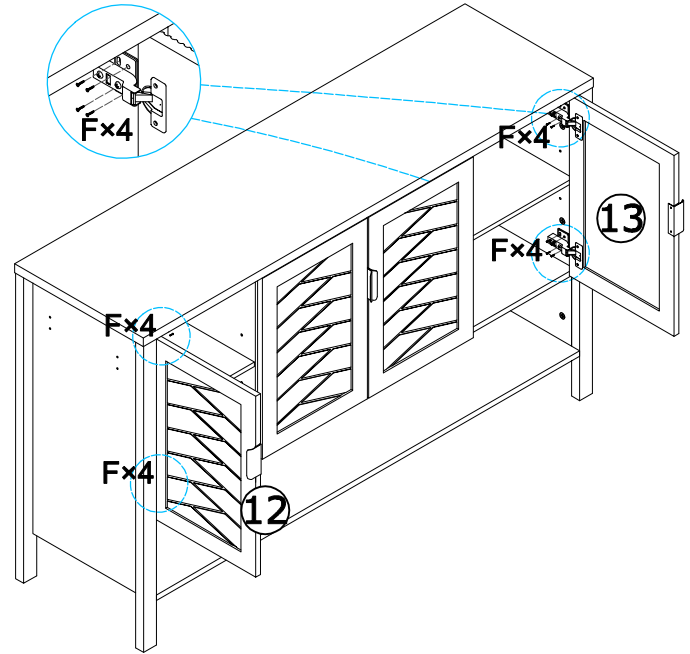

STEP 16

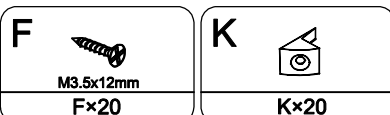
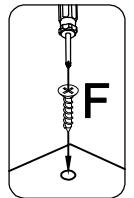
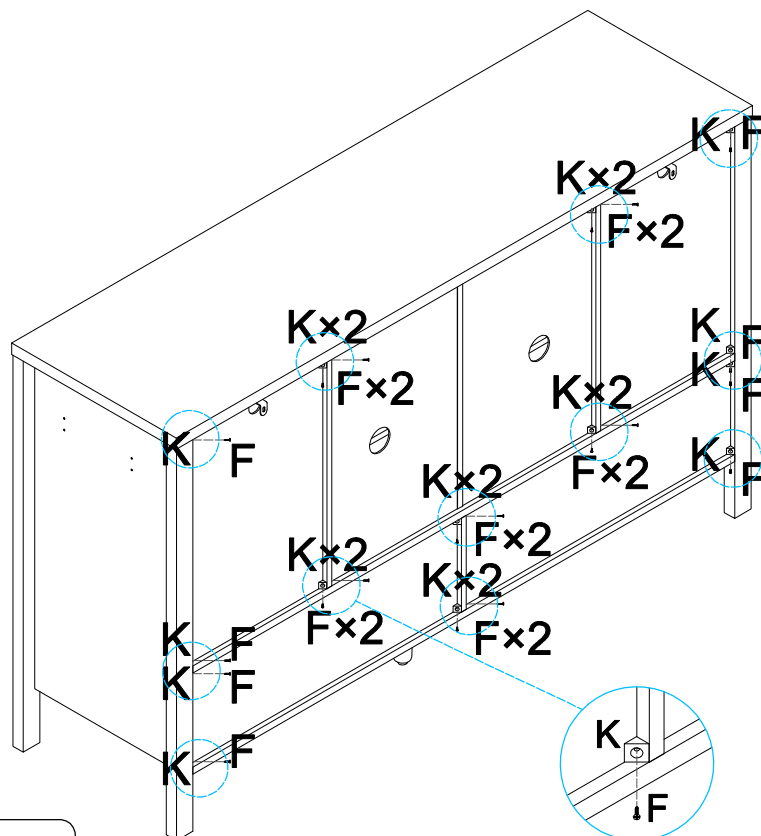

STEP 17

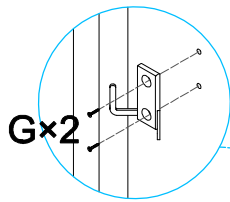
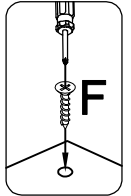

The hook can be freely installed left or right

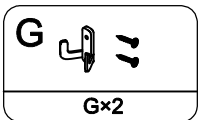
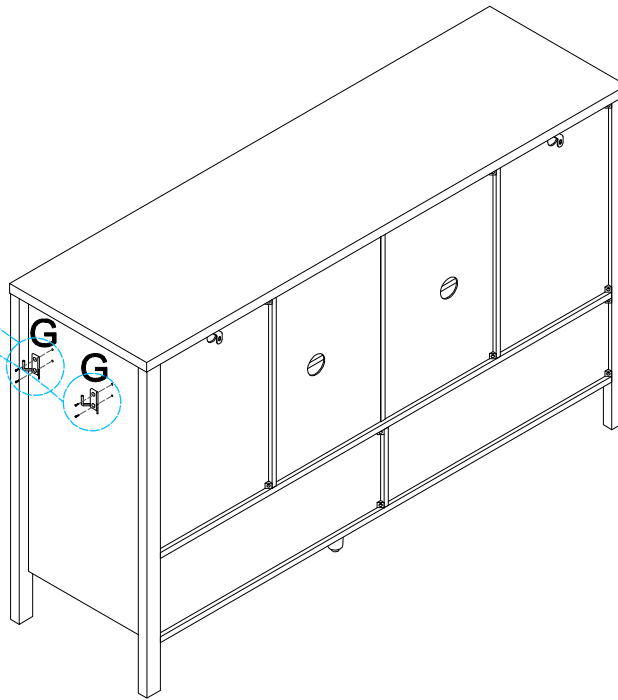

STEP 18

- Step 1. Mark the position on the wall.
- Step 2. Drill and insert the expandable screw L by hammer.
- Step 3. Use screw L to attach it and tighten by screwdriver.

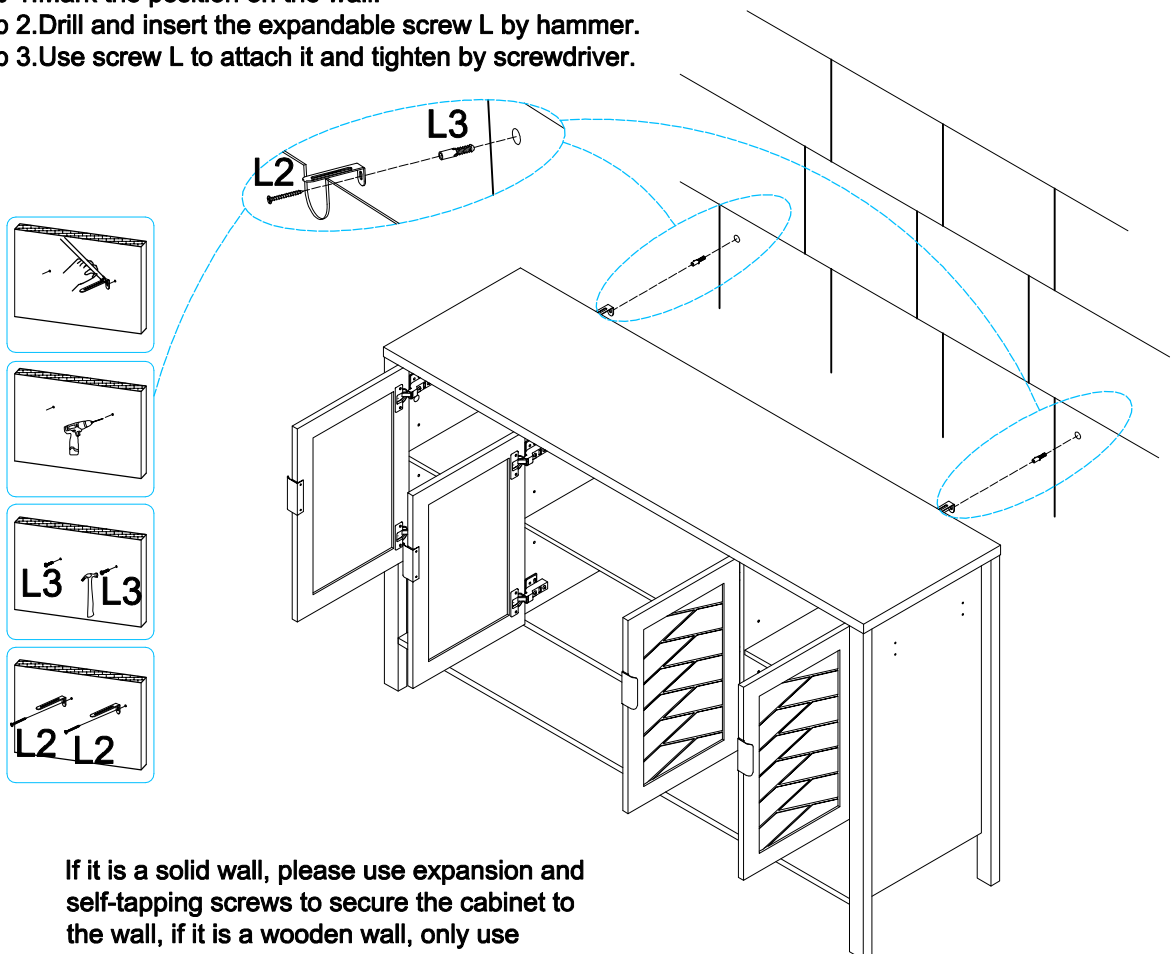

If it is a solid wall, please use expansion and self-tapping screws to secure the cabinet to the wall, if it is a wooden wall, only use self-tapping screws. Please don't overtighten screws.

