

Assembly Instruction

Step 1

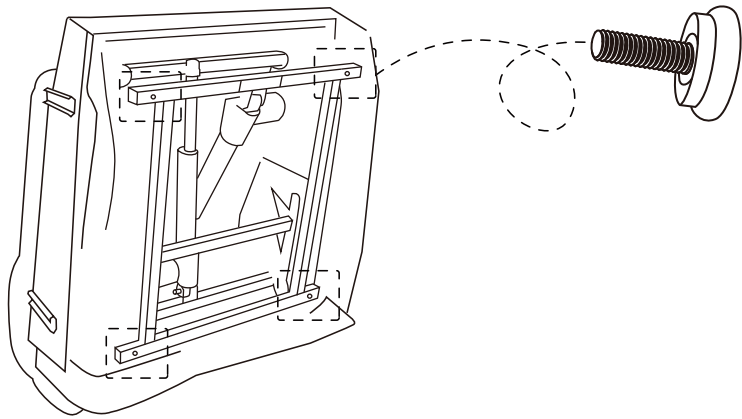

Step 2

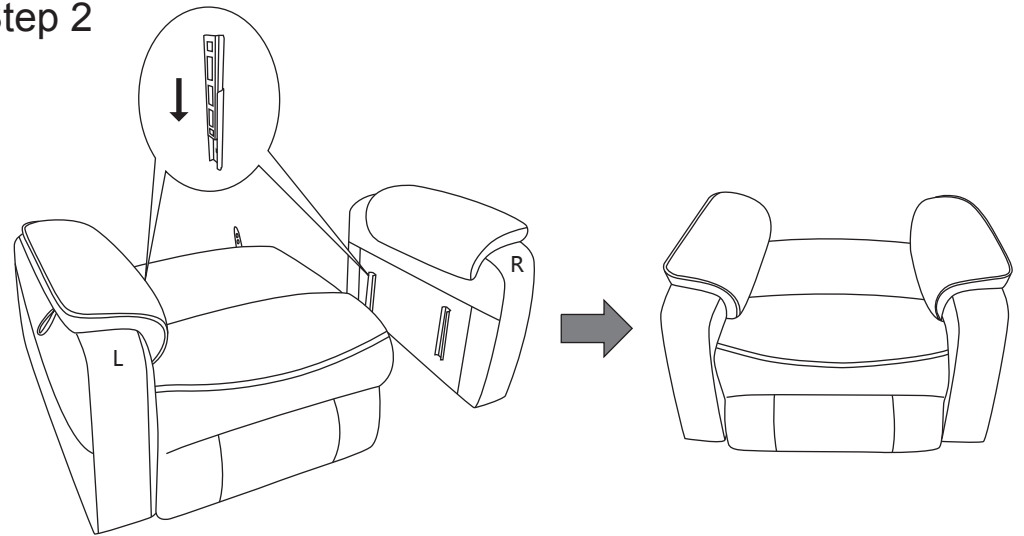

Step 3

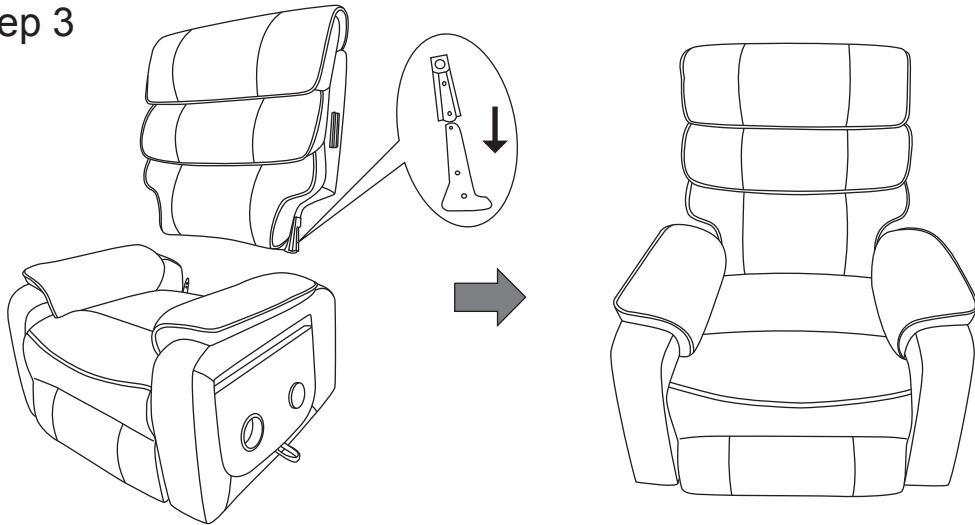

Step 4

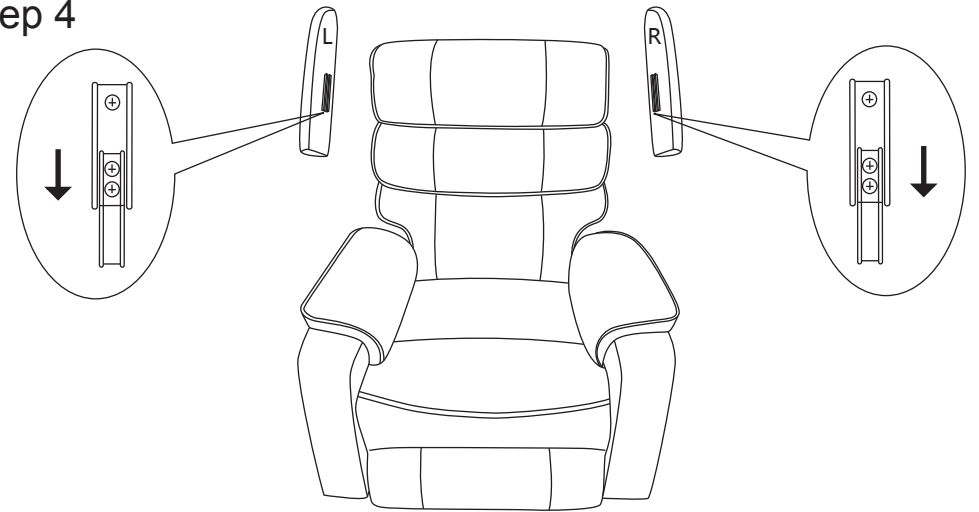

A*1

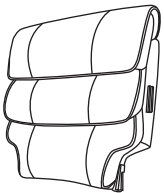

B*1

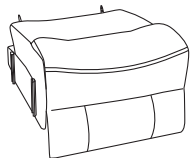

C*1

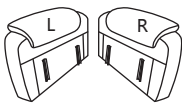

D*1

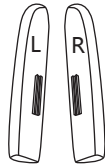

E*4

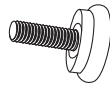

F*1



G*1

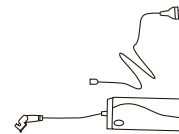

H*1



I*1

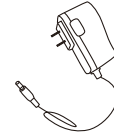

J*1

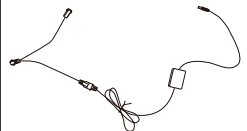

Assembly Instruction

Step 5

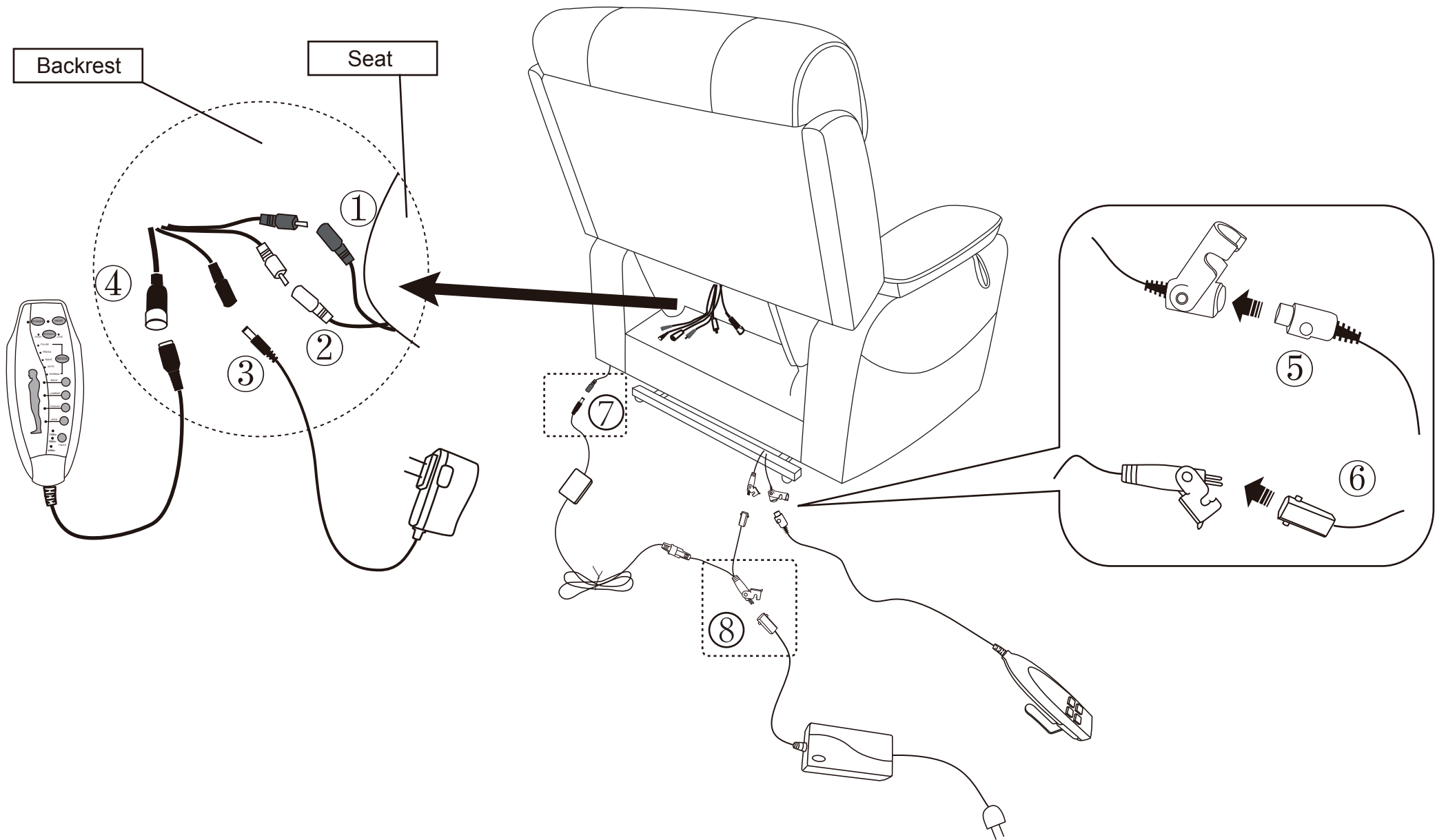

Assembly Instruction

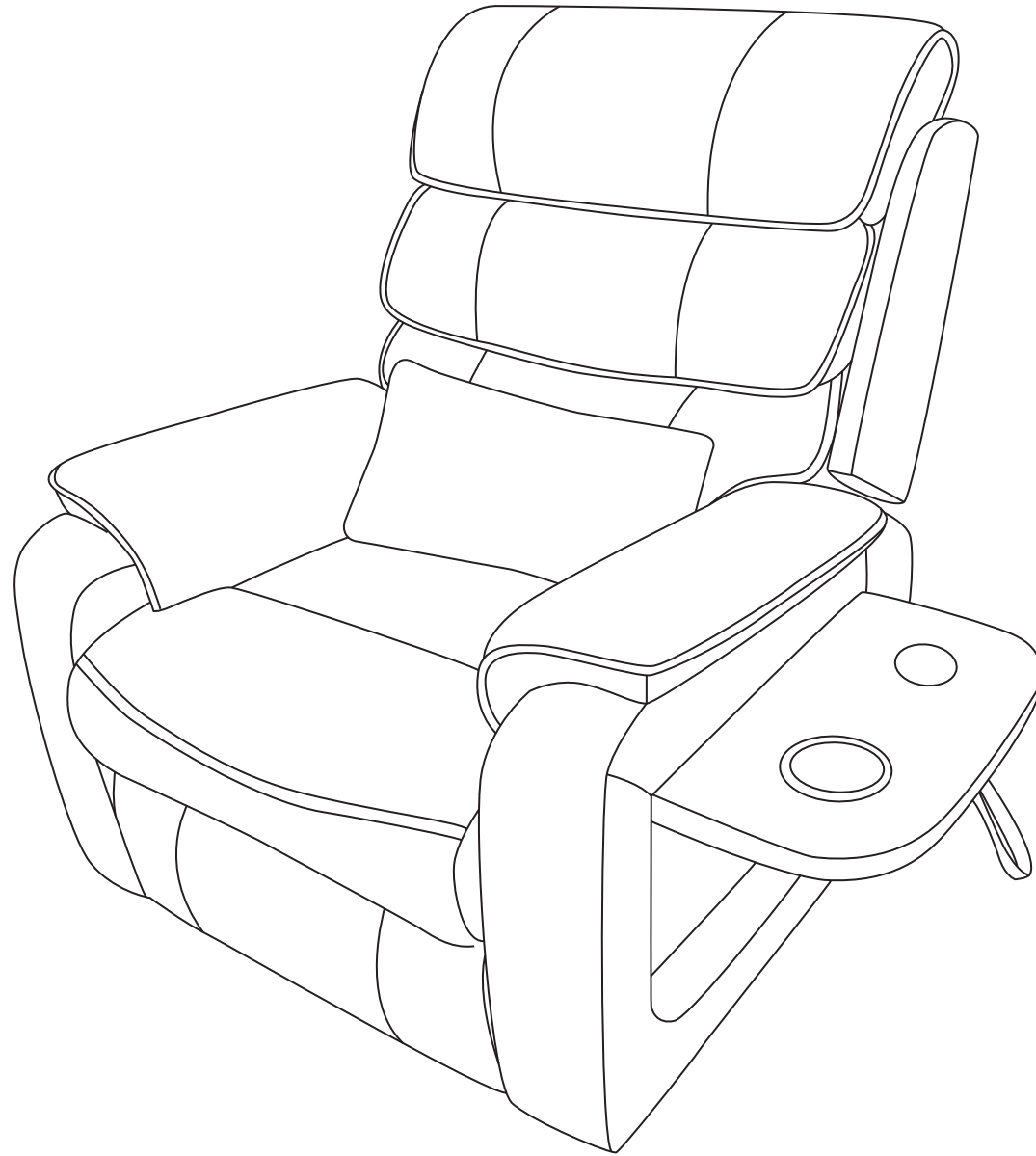

Remote Operation Instruction

