

5

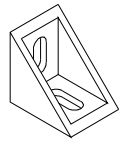

L - BRACKET 4PCS

6



SHORT SCREW 8PCS

STEP 11

TURN 180°

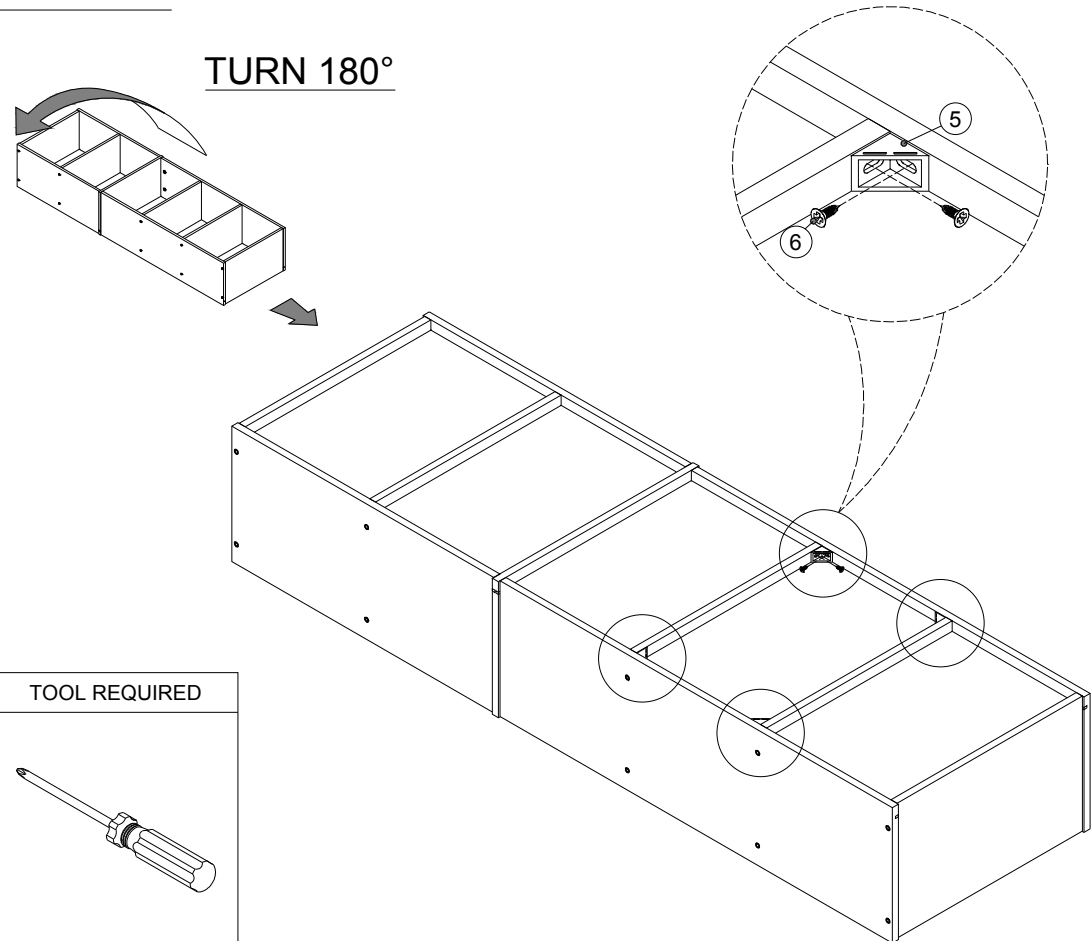

TOOL REQUIRED

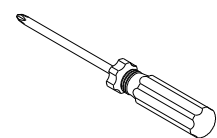

8

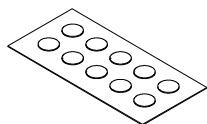

STICKER 20PCS

STEP 12

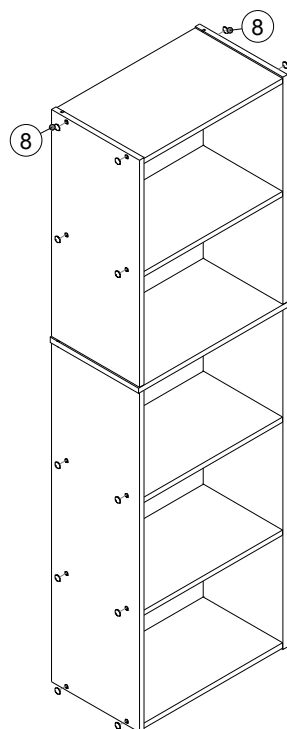

Recommended Maximum Weight

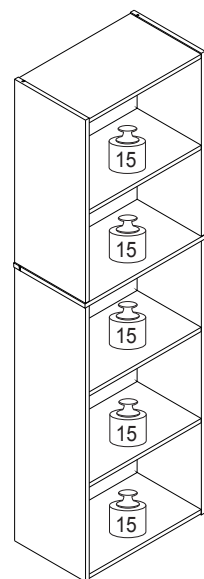

*Unit in Pound(lbs.)

WARNING:

>This unit has been designed to support the maximum loads shown. Exceeding these load limits could cause sagging, instability, product collapse, and/or serious injury.

>DO NOT allow children to climb on unit.

> Put heavier items on lower shelves.



Fits Space, Fits Budget

Assembly Instruction

Furinno 5 - Tier Open Shelf Bookcase
MODEL : 11055

00:50

Approx. 50 minutes



Recomm. 2 Persons

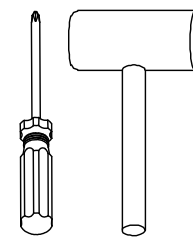

Tools Required

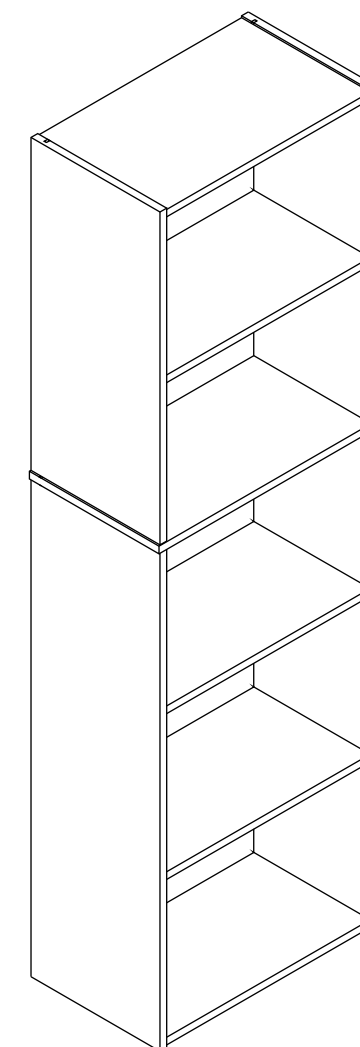

Customer Support

NEED HELP? For replacement requests or product inquiries, please contact our Customer Service Team by emailing us at support@furinno.com. Thank you for selecting Furinno!

www.furinno.com



EXPLODED VIEW

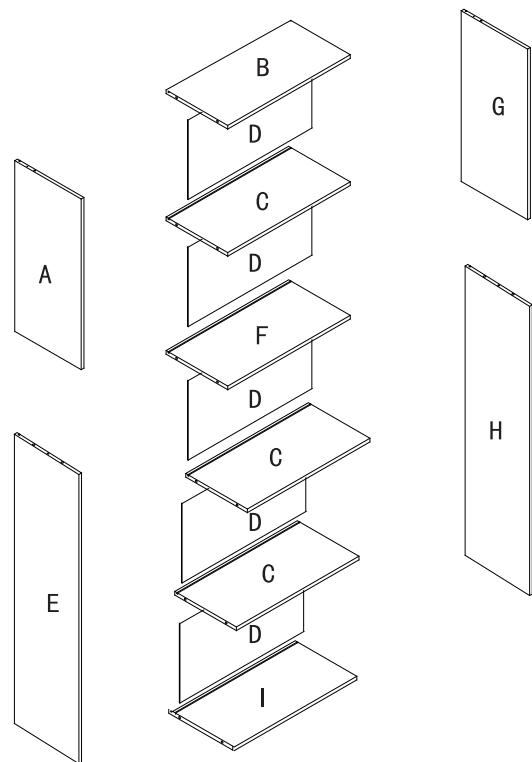

PARTS LIST

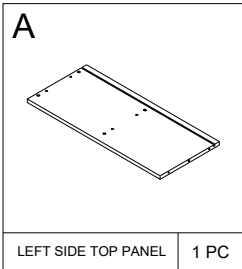
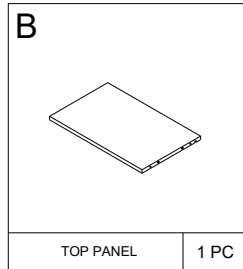
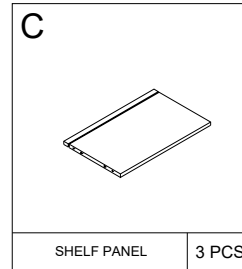
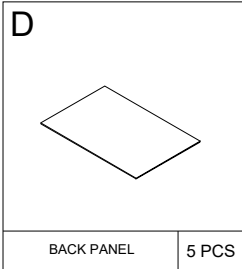
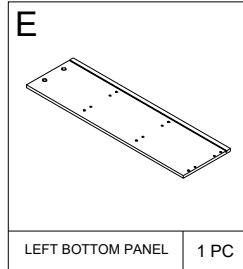
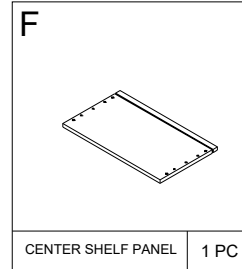
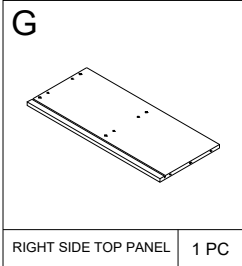
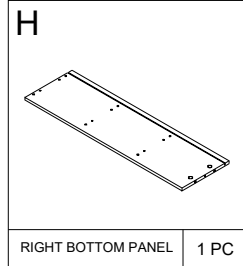
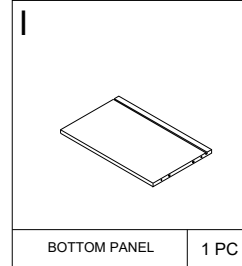
 LEFT SIDE TOP PANEL 1 PC	 TOP PANEL 1 PC	 SHELF PANEL 3 PCS
 BACK PANEL 5 PCS	 RIGHT BOTTOM PANEL 1 PC	 CENTER SHELF PANEL 1 PC
 RIGHT SIDE TOP PANEL 1 PC	 RIGHT BOTTOM PANEL 1 PC	 BOTTOM PANEL 1 PC

HARDWARE LIST

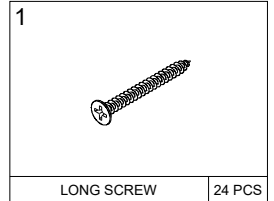
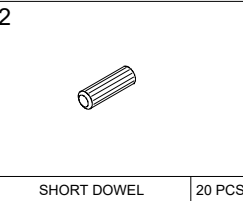
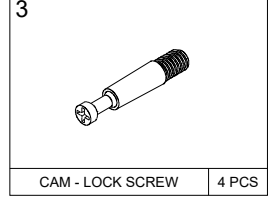
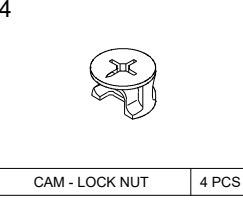
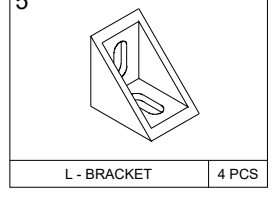
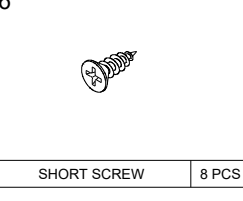
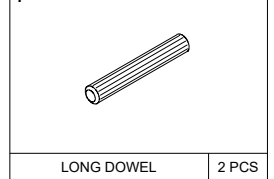
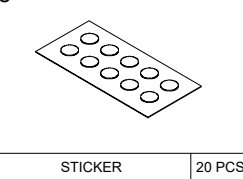
 LONG SCREW 24 PCS	 SHORT DOWEL 20 PCS
 CAM - LOCK SCREW 4 PCS	 CAM - LOCK NUT 4 PCS
 L - BRACKET 4 PCS	 SHORT SCREW 8 PCS
 LONG DOWEL 2 PCS	 STICKER 20 PCS

USEFUL HINTS BEFORE YOU START:

1. Read each step carefully before starting.
2. It is important that each step is performed in correct order to avoid difficulties.
3. Identify, soft and count the parts before assembly.
4. Assemble your furniture on packaging cardboard to prevent scratch or damage.
5. Clean the product with mild cleanser using soft damped cloth. Do not use harsh or abrasive cleanser.
6. Using incompatible hardware might cause damage to product.

1

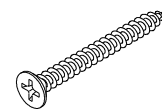

LONG SCREW | 6 PCS

STEP 9

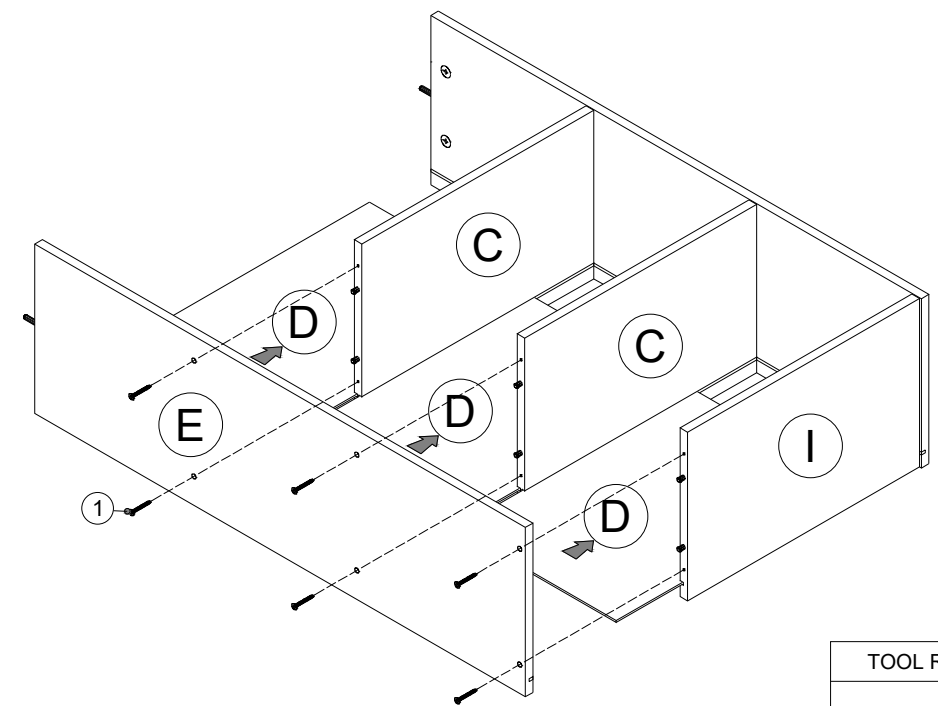

TOOL REQUIRED

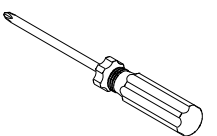

STEP 10

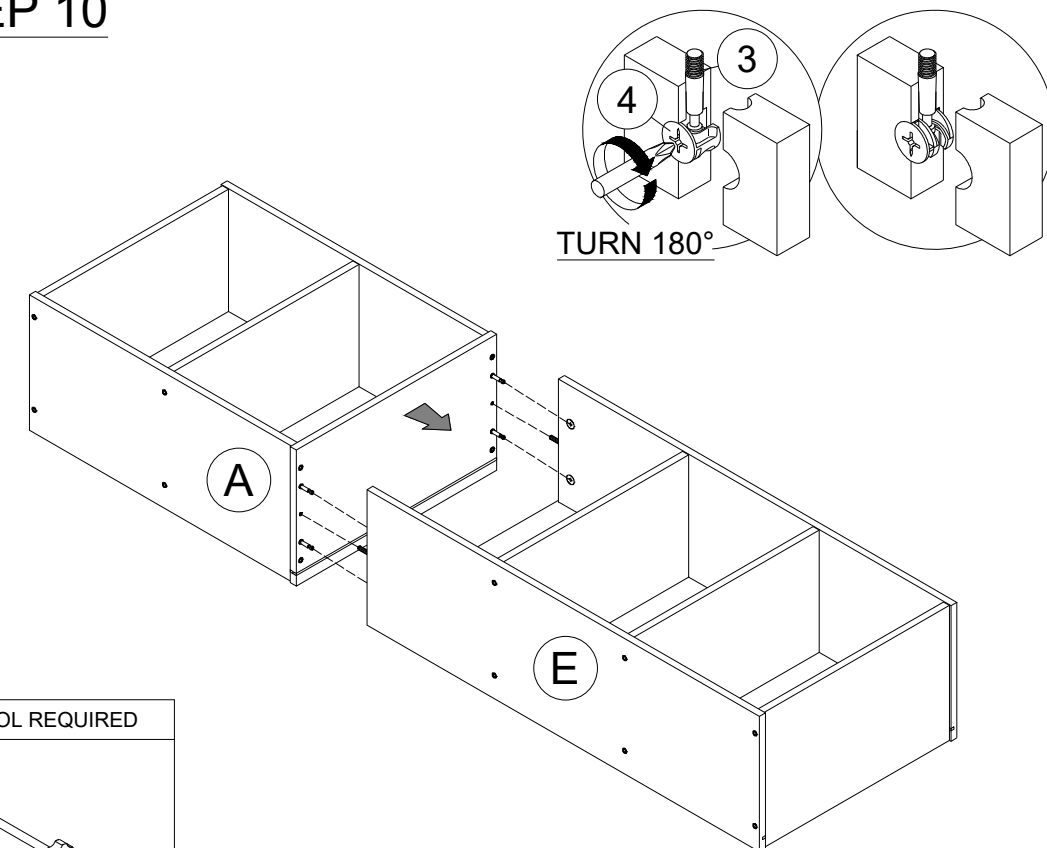

TOOL REQUIRED

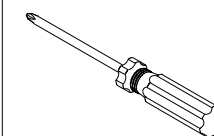

1

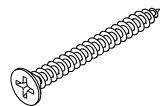

LONG SCREW 4 PCS

STEP 7

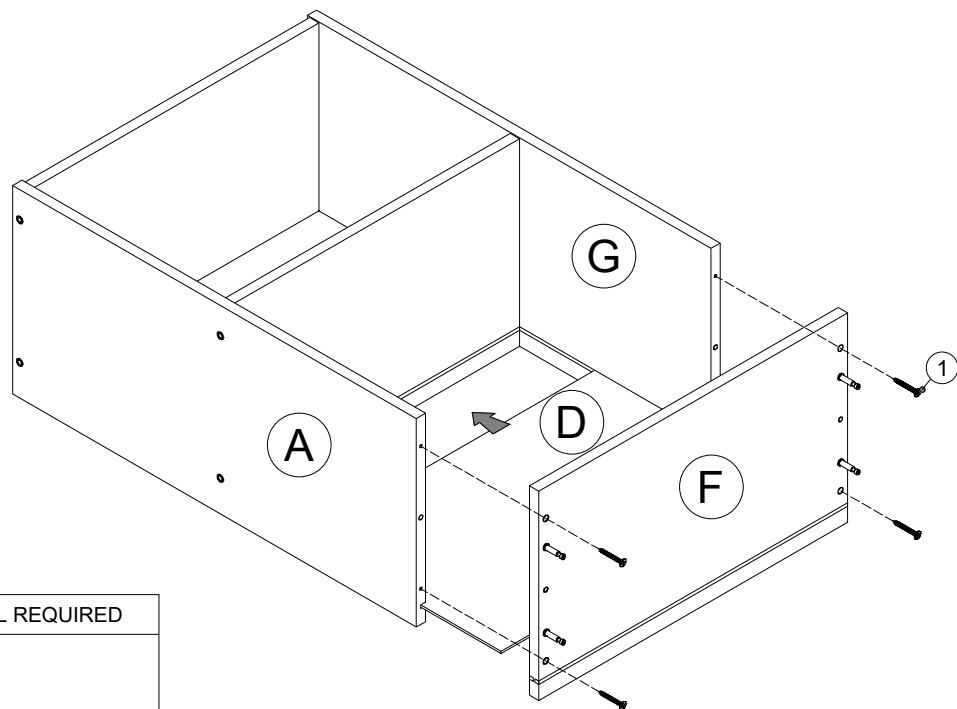

TOOL REQUIRED

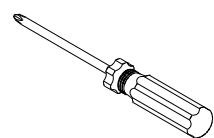

1

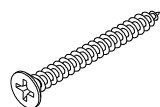

LONG SCREW 6 PCS

STEP 8

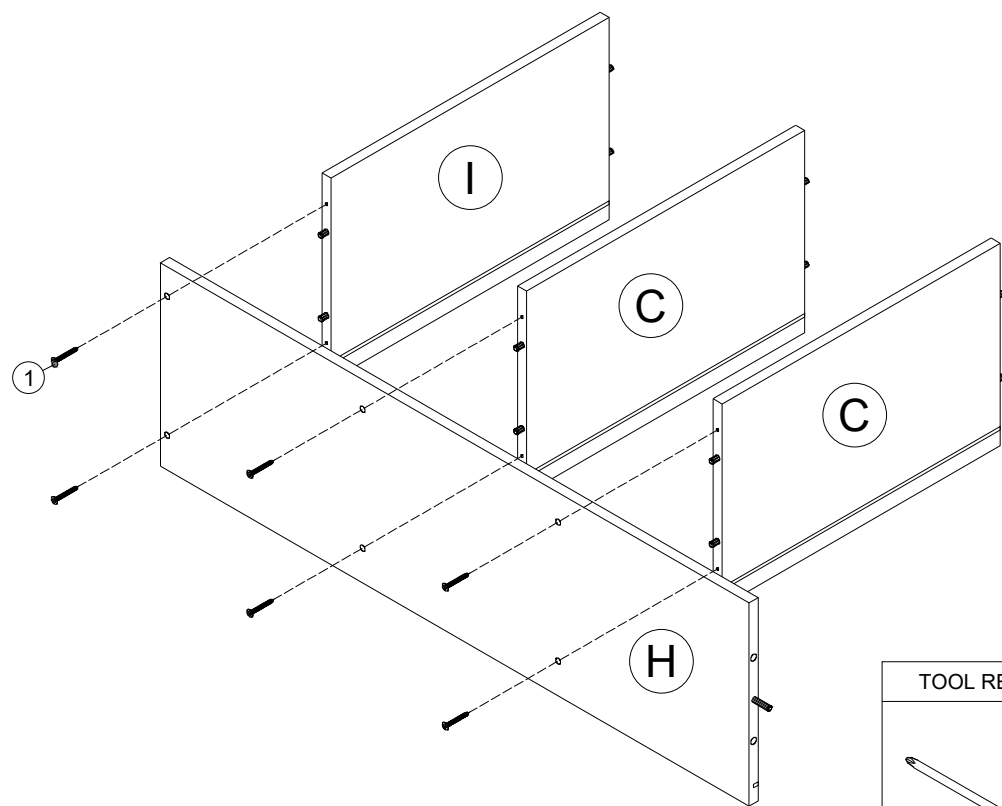

TOOL REQUIRED

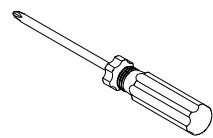

2



SHORT DOWEL 20PCS

STEP 1

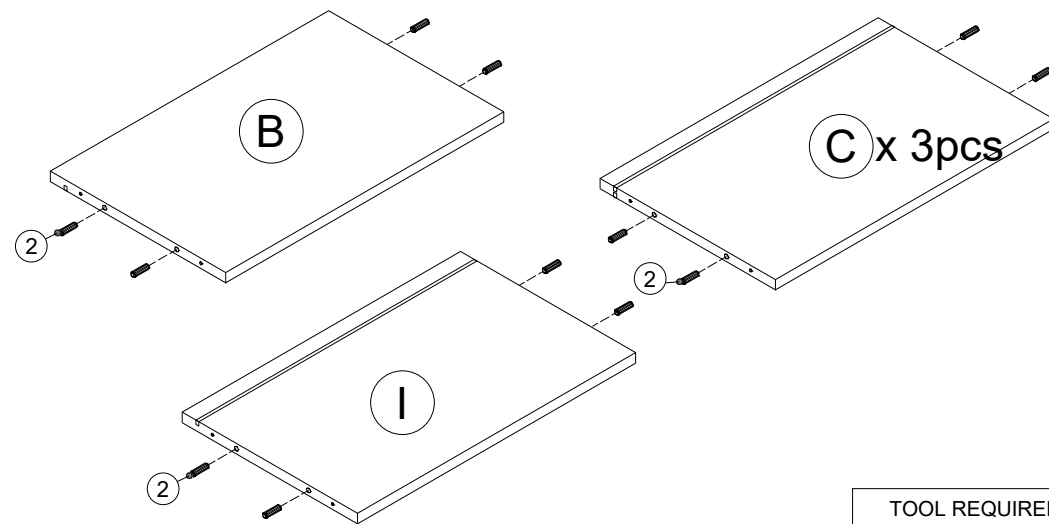

TOOL REQUIRED

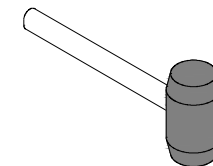

3

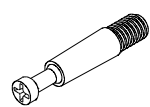

CAM-LOCK SCREW 4PCS

STEP 2

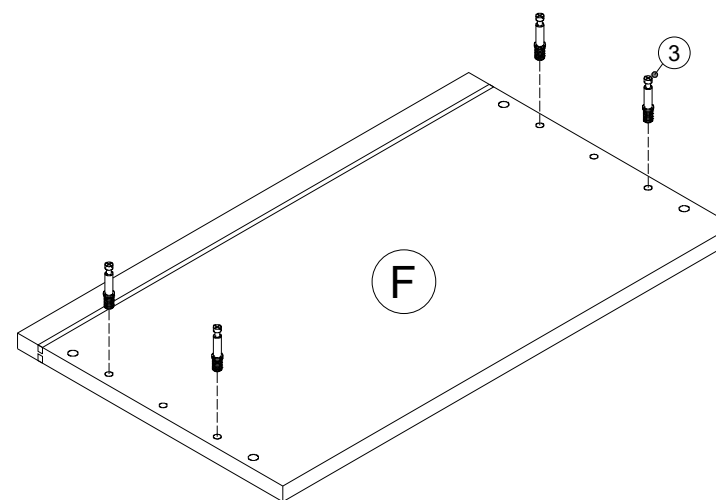

TOOL REQUIRED

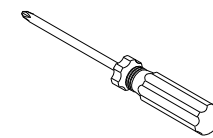

7

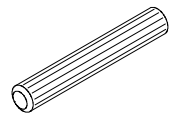

LONG DOWEL 2 PCS

4



CAM-LOCK NUT 4 PCS

STEP 3

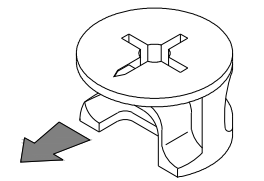
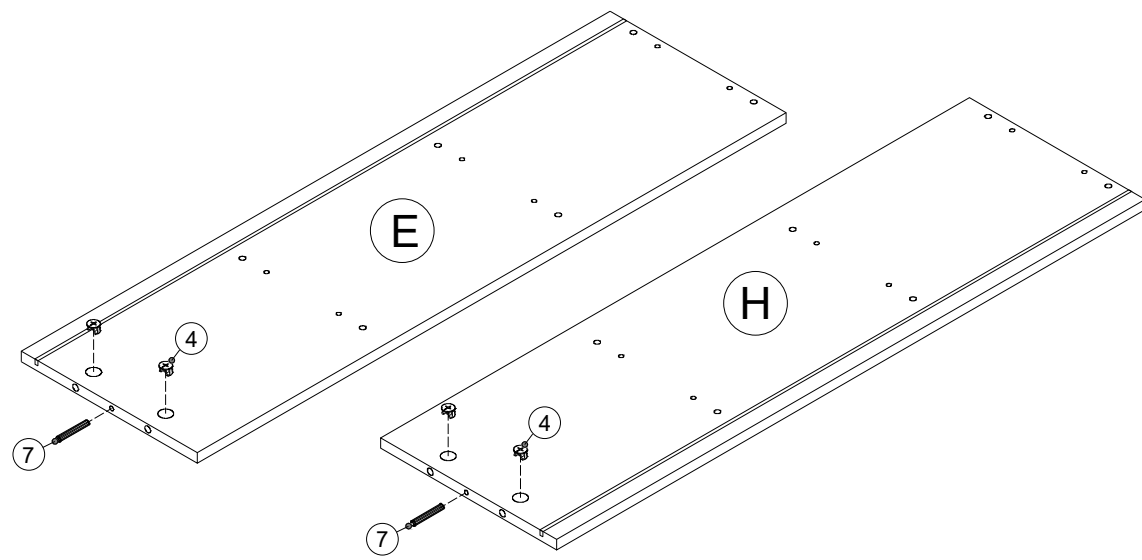

ARROW FACING OUTWARD

TOOL REQUIRED

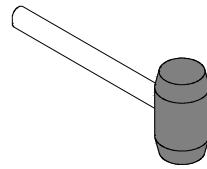

1

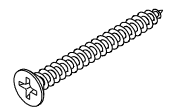

LONG SCREW 4 PCS

STEP 4

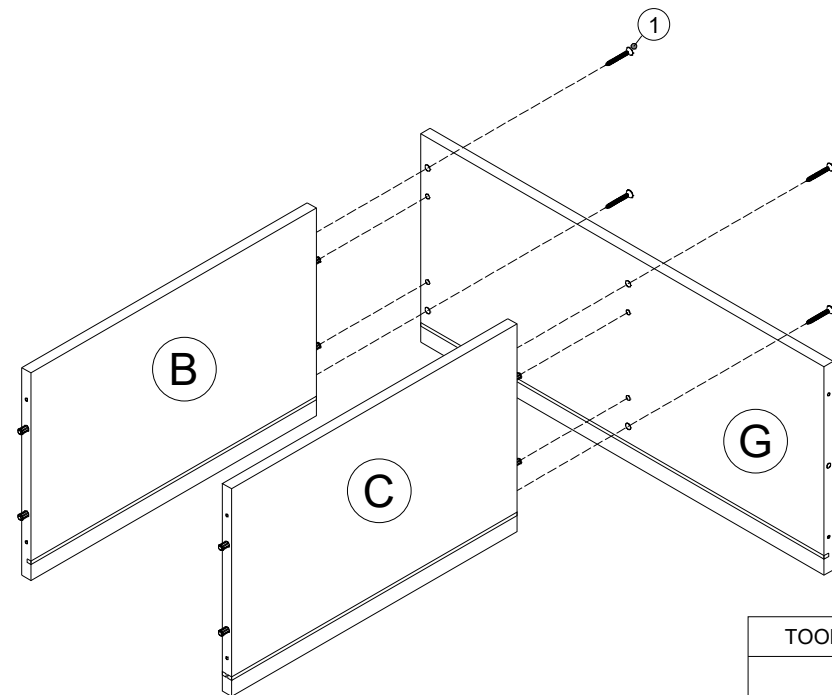

TOOL REQUIRED

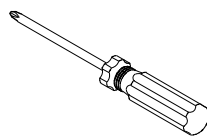

STEP 5

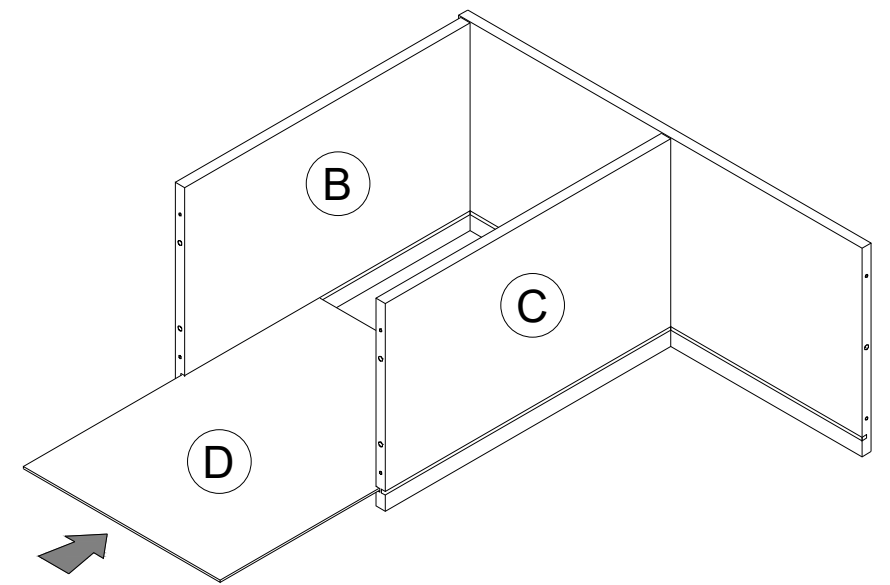

1

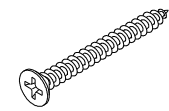

LONG SCREW 4 PCS

STEP 6

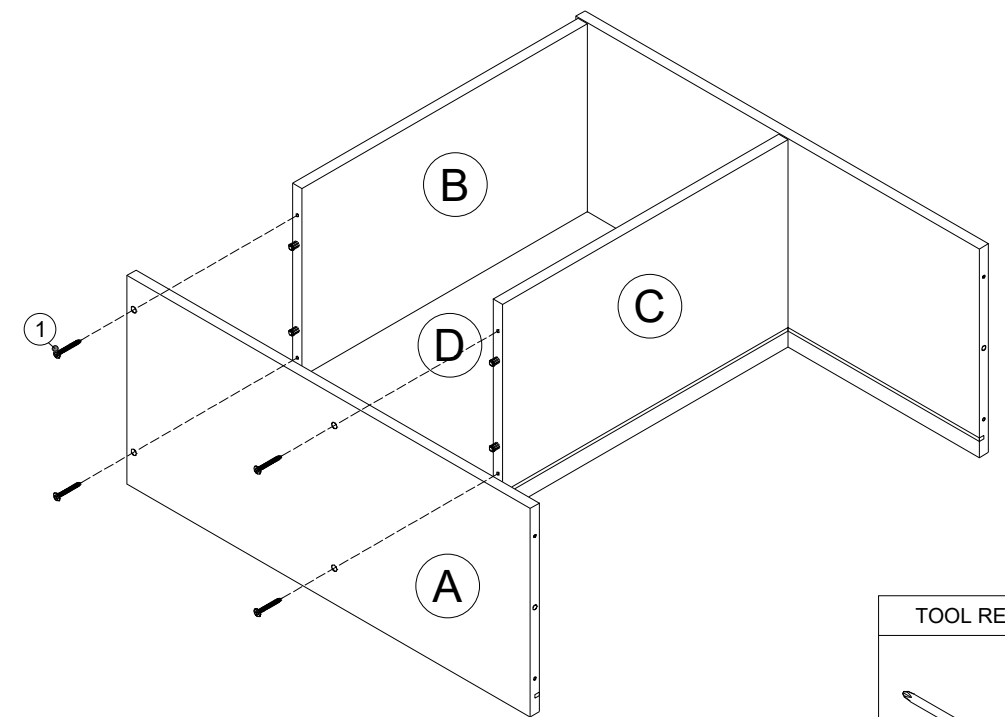

TOOL REQUIRED

