

NOTICE

- * Please make sure that you have all parts indicated and they are in good condition before you begin assembly of this item. Refer to part list and hardware list below for guidance.
- * This item should be assembled on a soft surface to prevent scratching the finish during assembly.
- * This item may require periodic tightening.
- * If you are having difficulty, our friendly Customer Care team is always here to help.









PREPARATION

- * Before beginning assembly of product, make sure all parts are present. Compare parts with part contents list and hardware contents list.
- * If any part is missing or damaged, do not attempt to assemble the product.
- * Estimated Assembly Time: 10 minutes.
- * Tools Required for Assembly (included): Allen Key

CARE AND MAINTENANCE

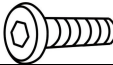
Dust with a soft, dry cloth. Do not use abrasive cleaner. To clean glass, spray a small amount of glass cleaner onto a lint-free cloth and wipe glass clean.

Part List and Hardware List

Piece	Description	Picture	Quantity
A	Top Frame		1 X
B	Leg		3 X
C	Shelf		1 X
D	Top Glass		1 X
HW1	Allen Bolt (M6x1x10mm)		9 X
HW2	Glass Mat		6 X
HW3	Felt Pad		3 X
HW4	Allen Key		1 X

Product Dimensions: 35.9"Wx15.3"Dx31.3"H

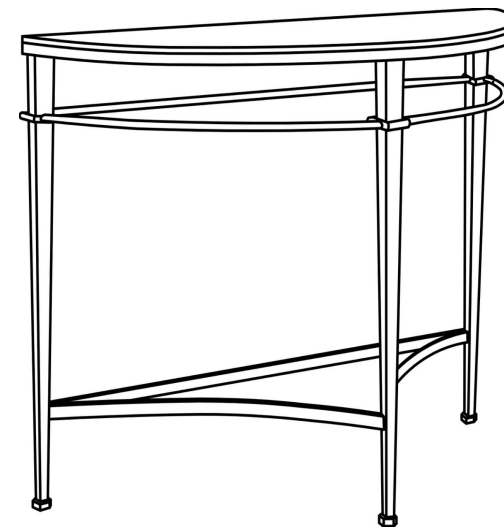

⚠ WARNING ⚠

Weight Capacity-80LBS
Warning:Do not stand on Table
Warning:Do not over torque bolts.

Preparation

*Before beginning assembly of product, make sure all parts are present. Compare parts with part contents list and hardware contents list.

*If any part is missing or damaged, do not attempt to assemble the product.

*Estimated Assembly Time: 10 minutes.

*Tools Required for Assembly (included): Allen Key

*If you are having difficulty, our friendly Customer Care team is always here to help.

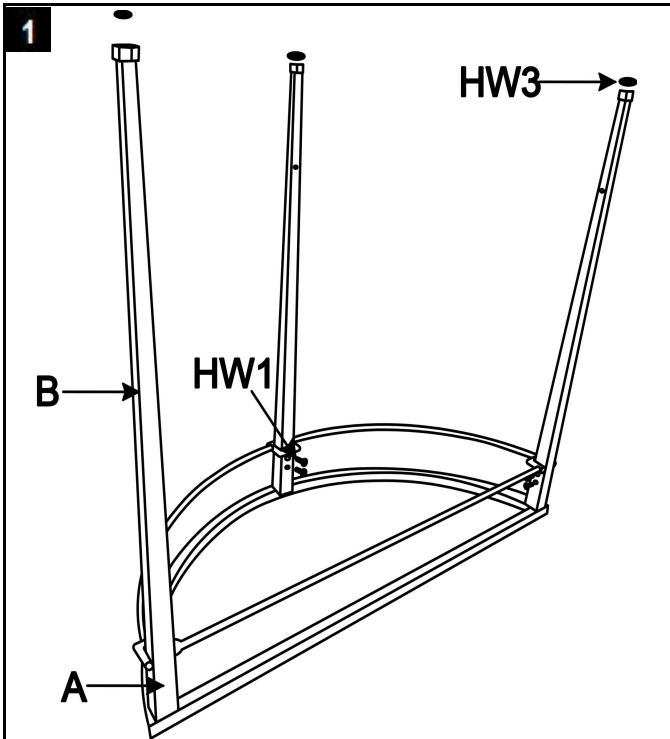

1 Attach Leg (B) and Top (A) together using Allen bolts(HW1).Do not tighten

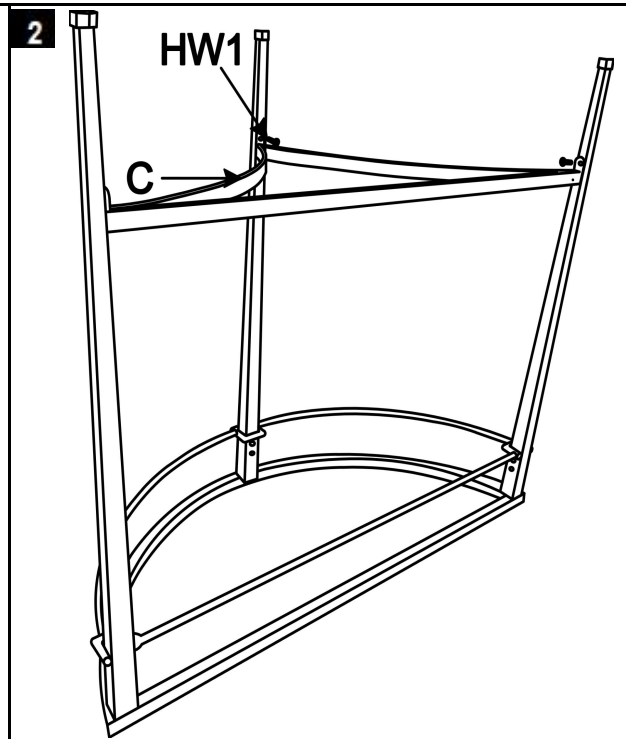

2 Attach Leg (B) and Shelf (C) together using Allen bolts(HW1).Tighten all Allen Bolt

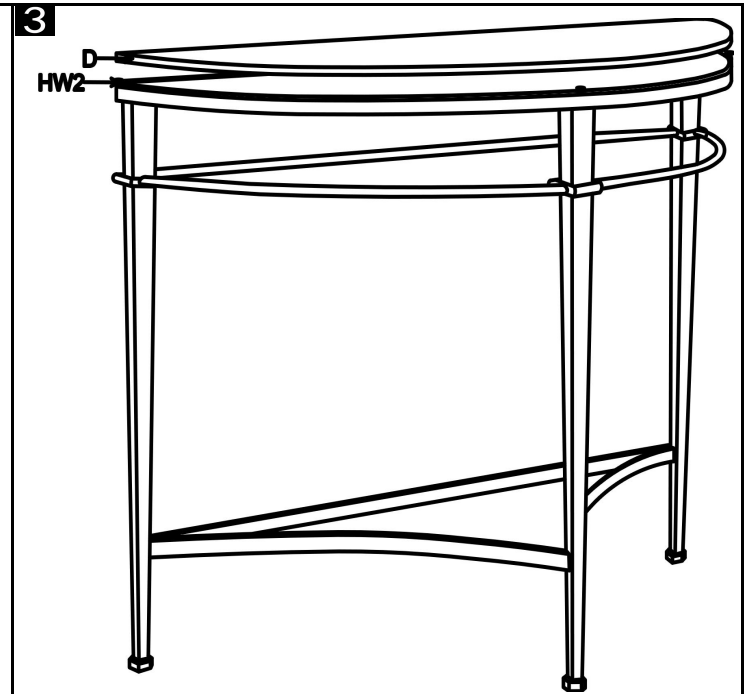

3 Place the Glass (D) onto the Top (A)