

Installation & Assembly

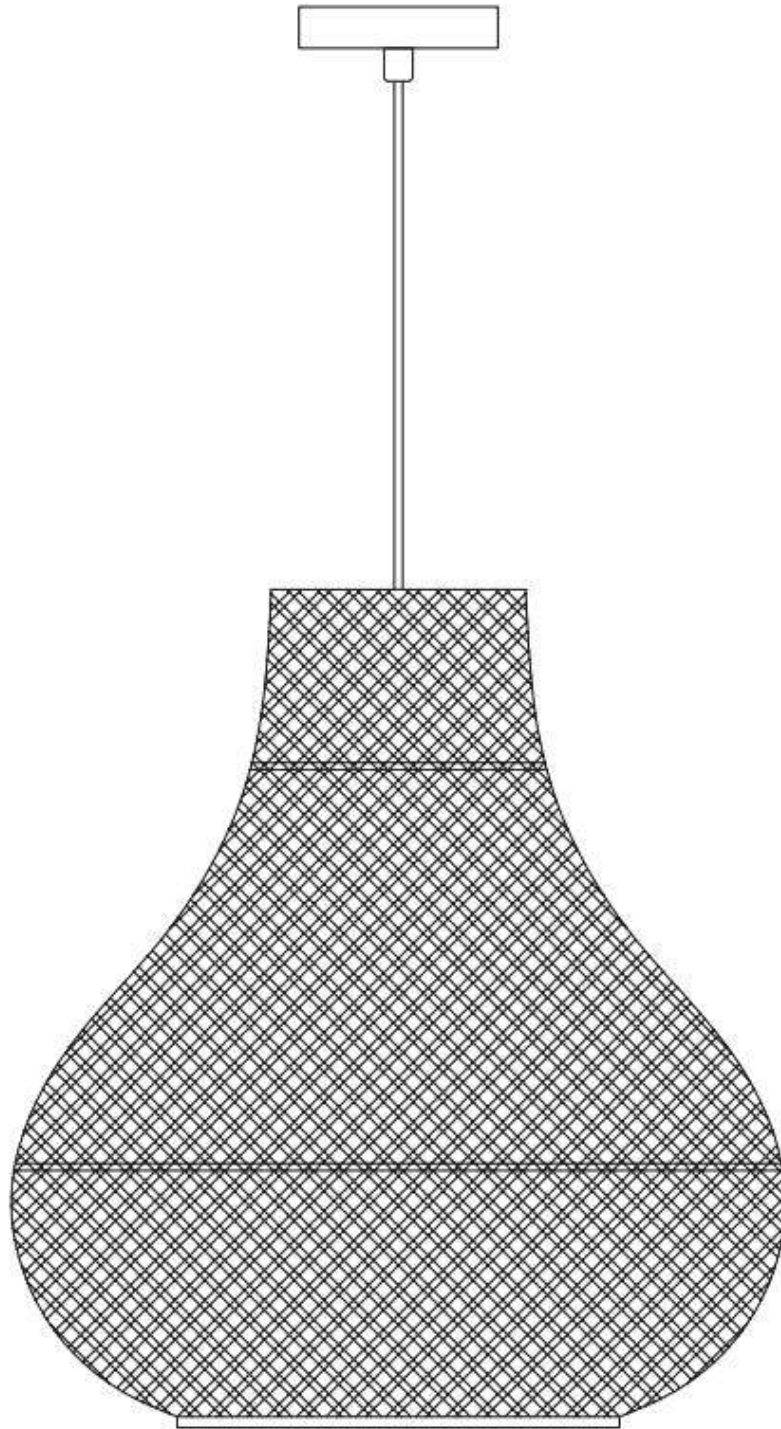

English

installation steps

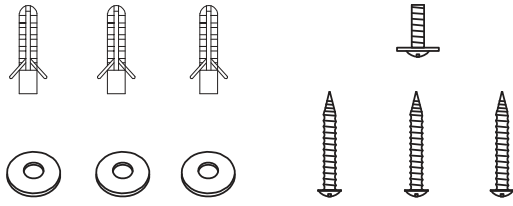

① List of Attachments

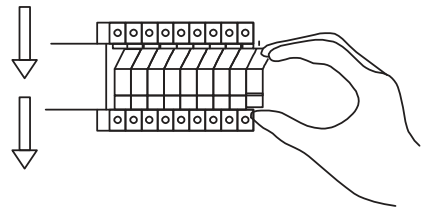

②

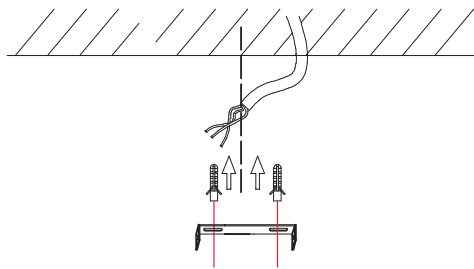

③

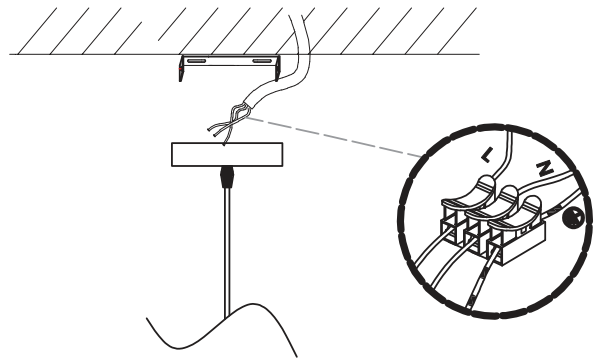

④

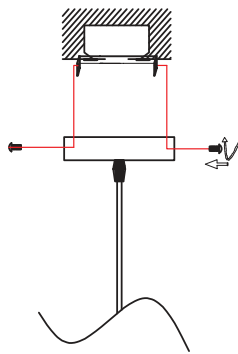

⑤



⑥

Bulb not included

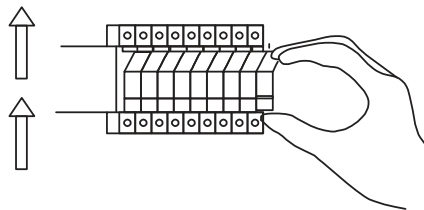

⑦

MAX:E27 1*60W Bulb not included

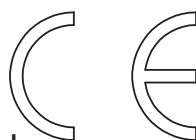

MADE IN CHINA

