

Top View

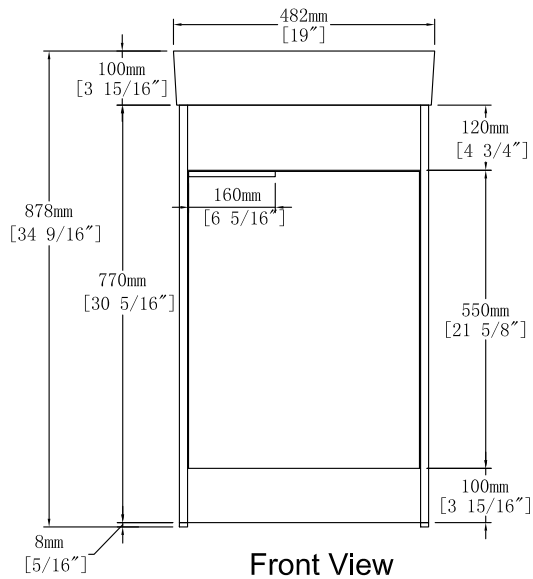

Front View

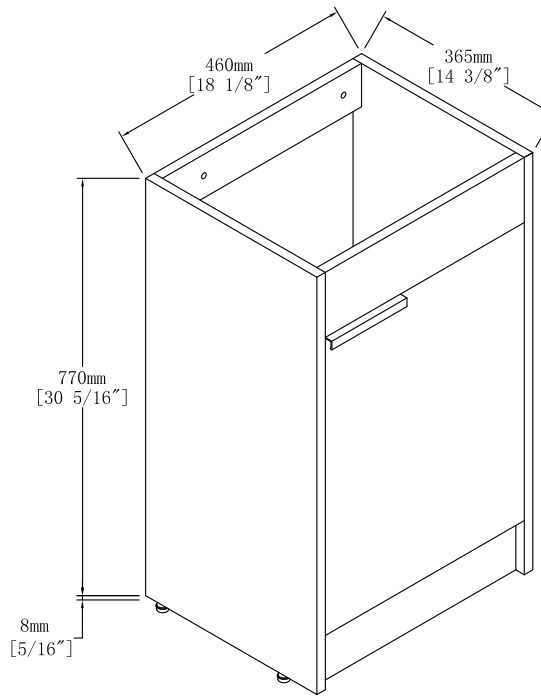
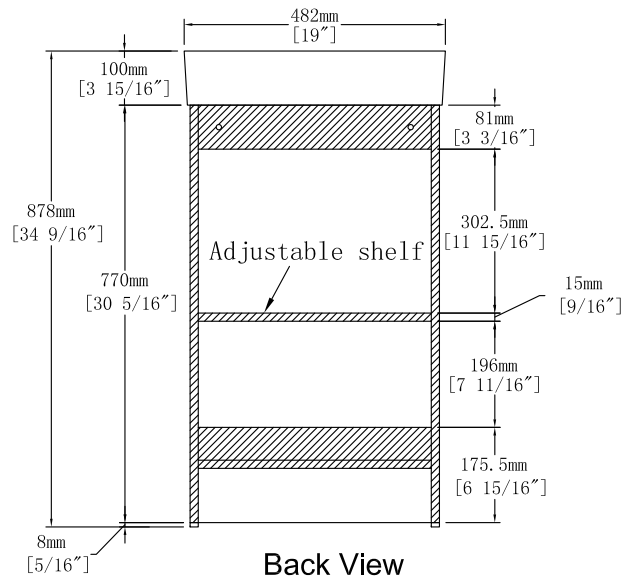

Back View

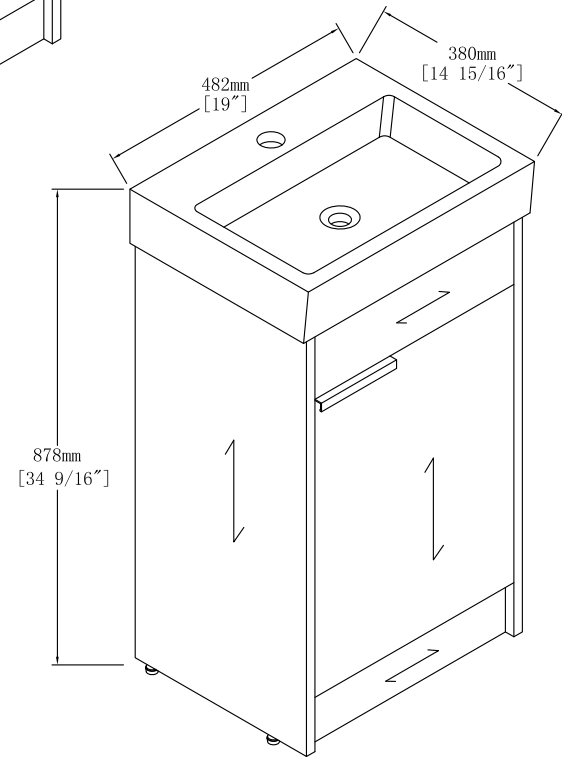

Item NO.

BV C01618

Version

V1

Projece

Date

2022-3-25