

Swing Chair

USER MANUAL

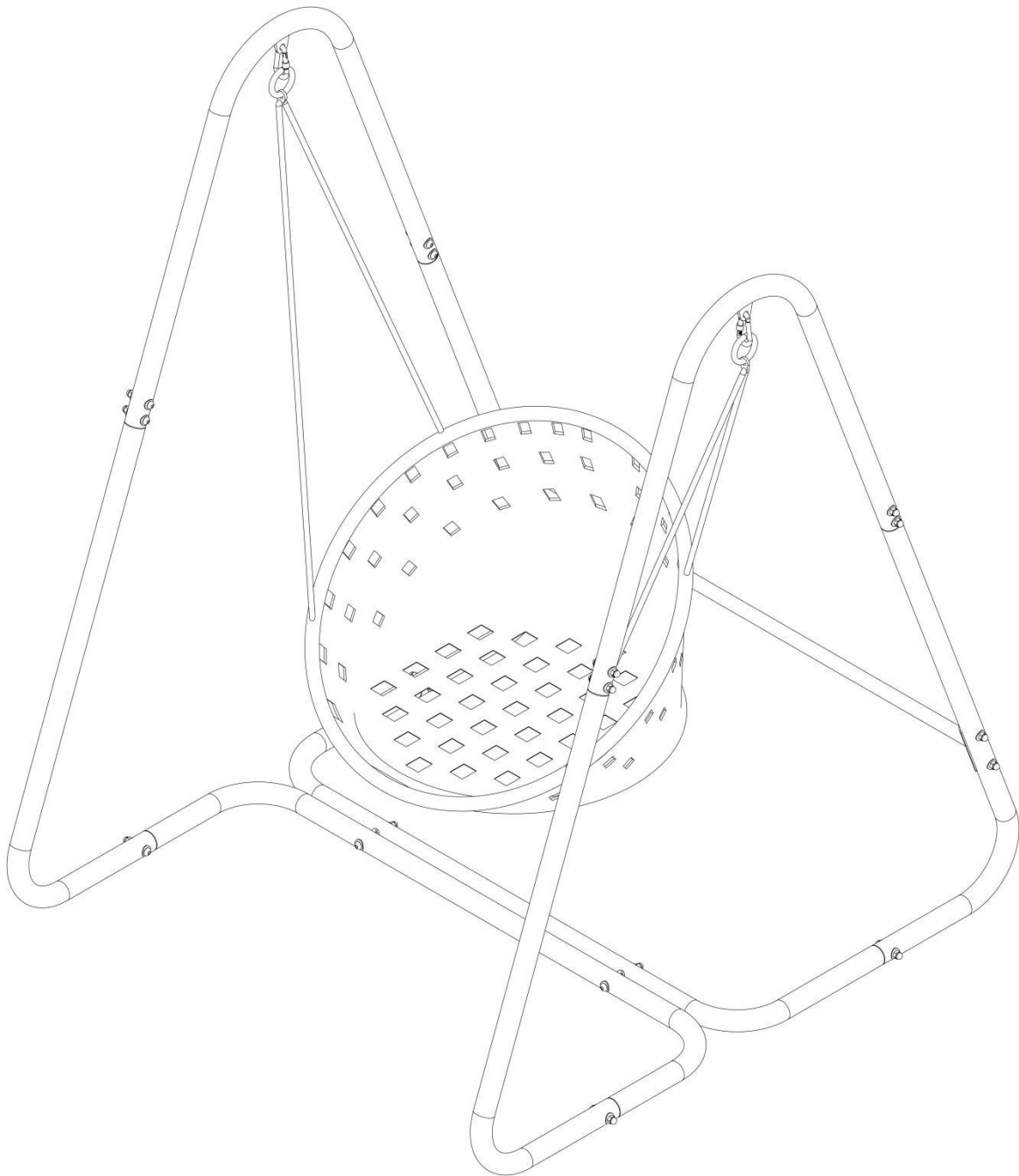

READ AND SAVE THIS INSTRUCTION FOR FUTURE USE

PLEASE DO NOT RETURN TO STORE



Please do not return this product to the retailer!

We are able to assist you in ANY way.

If you find that you have any trouble with assembly or missing or damaged parts please contact the seller.









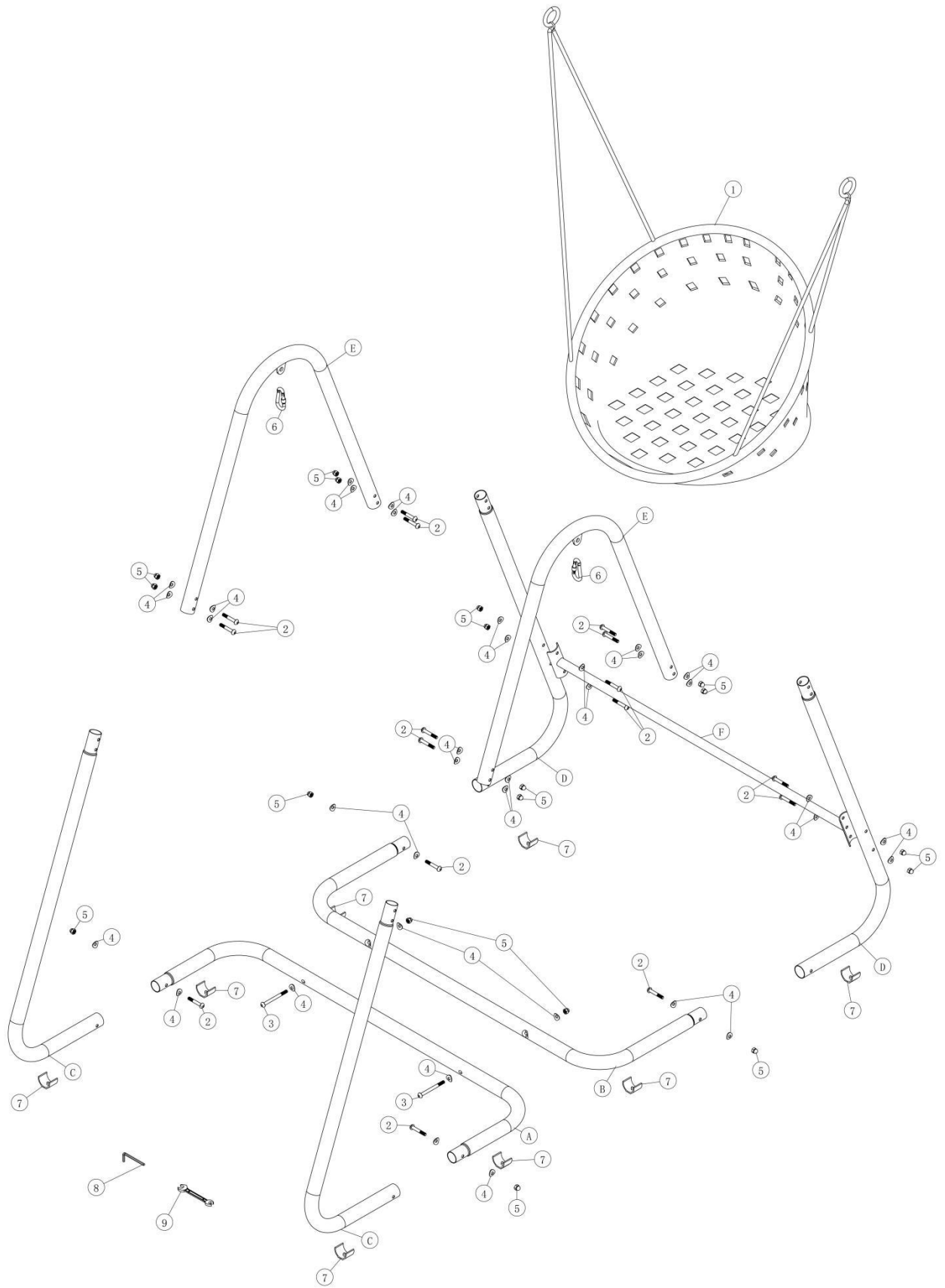



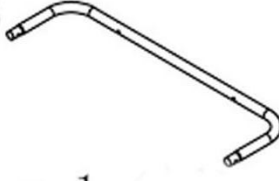
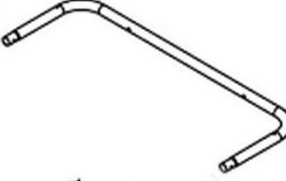
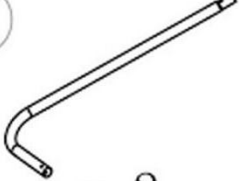

Notice: Please retain these instructions for future reference

- Do not stand on or use any part of this product as a step ladder.
- Firmly secure all bolts, screws and knobs before use.
- Reconfirm that all bolts, screws, and knobs are secure every 90 days.
- Do not use or store this item in the proximity of open flame or flammable / combustible chemicals.
- If any parts are missing, broken, damaged, or worn, stop using this product until repairs are made and/or factory replacement parts are installed.
- Do not use this item in a way inconsistent with the manufacturer's instructions as this could void the product warranty.
- Children should always be under direct adult supervision while using this product.
- This product is recommended for indoor use.
- Don't swing too high in case of any accident.

FOLLOW ALL ASSEMBLY INSTRUCTIONS AS WRITTEN IN THIS MANUAL.



Part List

<p>A</p>  <p>X 1 (SHORT)</p>	<p>B</p>  <p>X 1 (LONG)</p>	<p>C</p>  <p>X 2</p>
<p>D</p>  <p>X 2</p>	<p>E</p>  <p>X 2</p>	<p>F</p>  <p>X 1</p>
<p>1</p>  <p>X 1</p>	<p>2</p>  <p>X 16</p>	<p>3</p>  <p>X 2</p>
<p>4</p>  <p>X 36</p>	<p>5</p>  <p>X 18</p>	<p>6</p>  <p>X 2</p>
<p>7</p>  <p>X 8</p>	<p>8</p>  <p>X 1</p>	<p>9</p>  <p>X 1</p>

STEP 1:

Assemble 2 bottom tubes, put the bottom tube (A) bottom tube (B) on the level ground, use the screws (3) spacers (4) nuts (5) assembly fixed and locking.

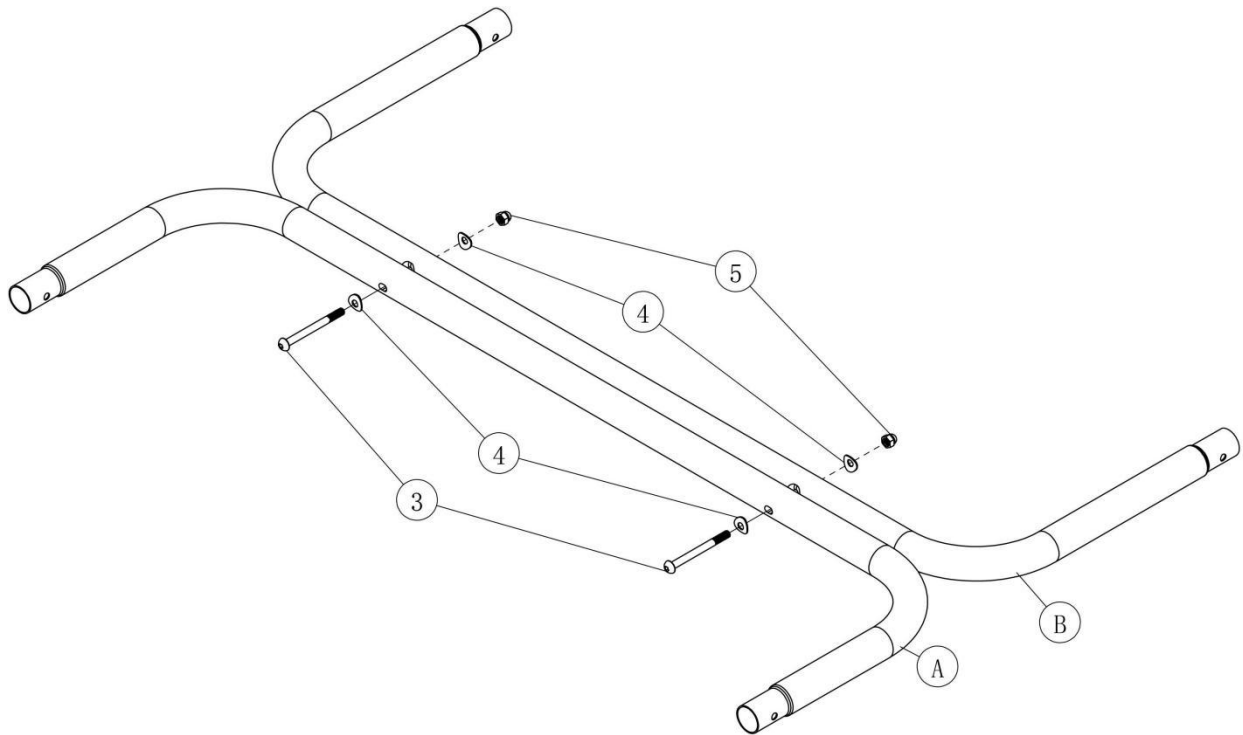

STEP 2:

Insert the front elbow (C) into the bottom tube (A), and then use the screws (2) spacers (4) nuts (5) to connect and assemble together and lock, and then insert the rear elbow (D) into the bottom tube (A), and then use the screws (2) spacers (4) nuts (5) to connect and assemble together and lock.

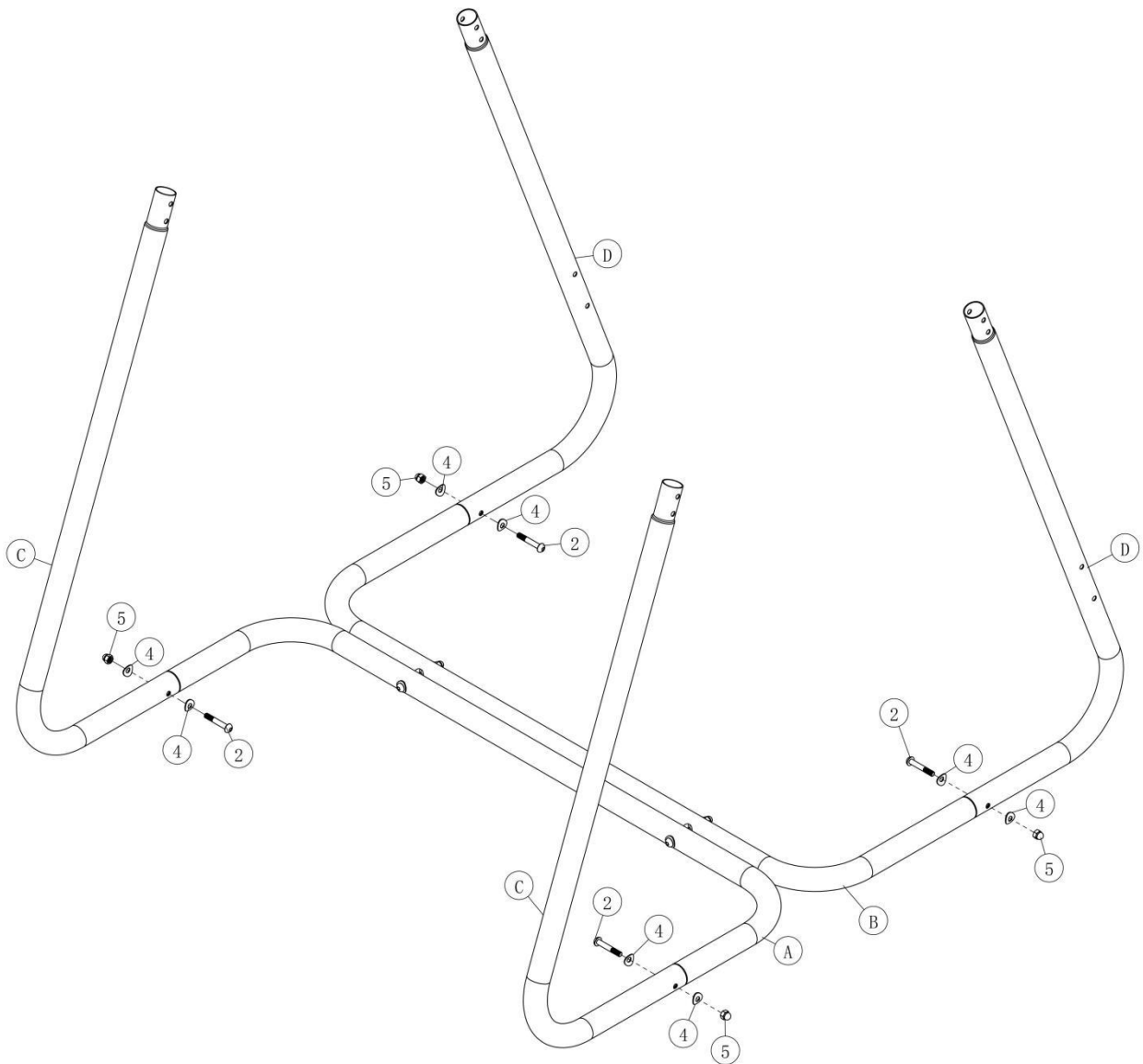

STEP 3:

Insert the top elbow (E) into the left side of the front elbow (C) and the rear elbow (D), with screws (2) spacers (4) nuts (5) assembly connection and screws.

Repeat the above step for the right side.

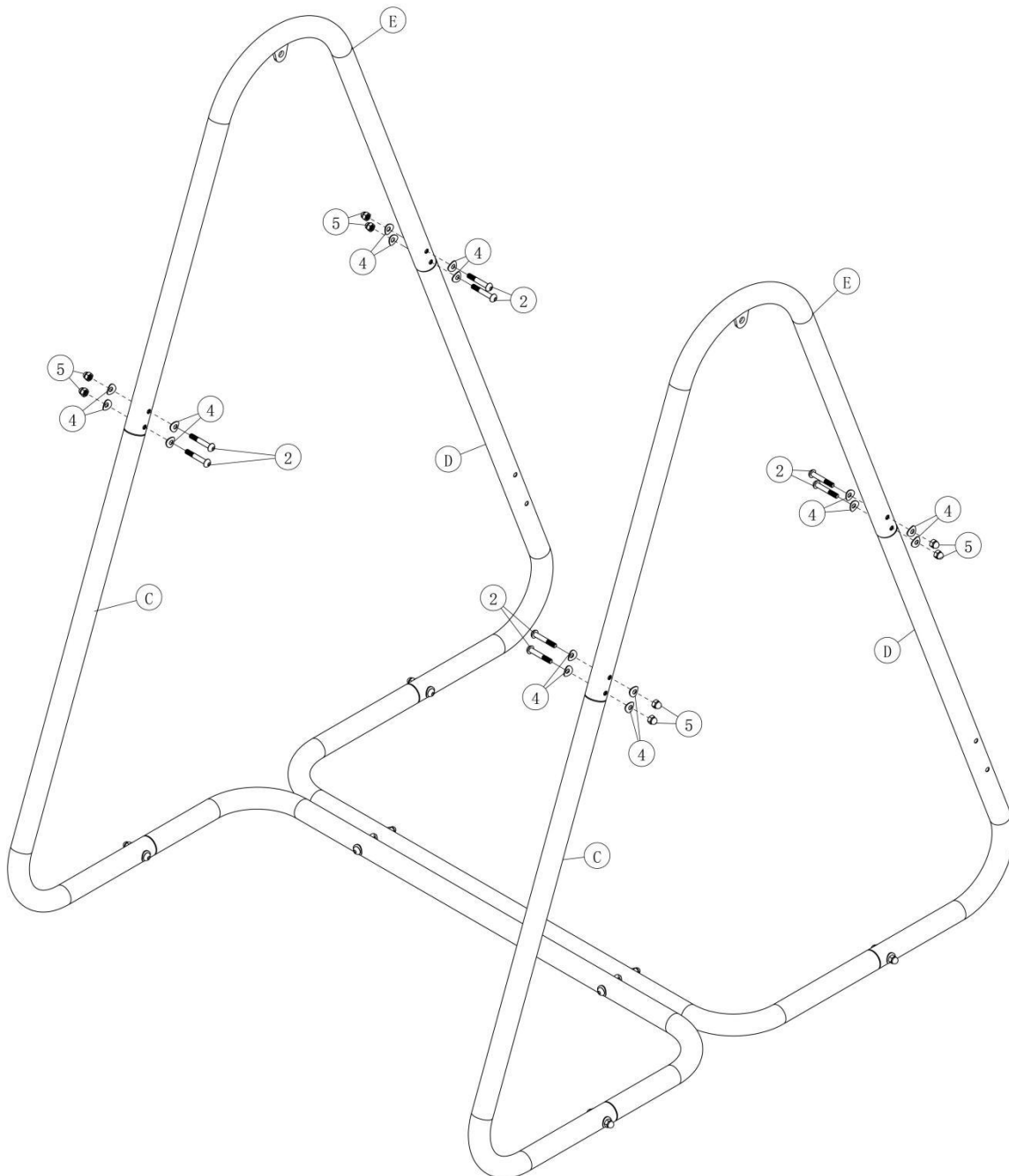

STEP 4:

Connecting tube (F) assembled to the 2 rear elbow (D), connecting tube (F) at both ends of the curved iron sheet of the holes aligned with the rear elbow of the holes, with the screws (2) spacers (4) nuts (5) assembled and locking.

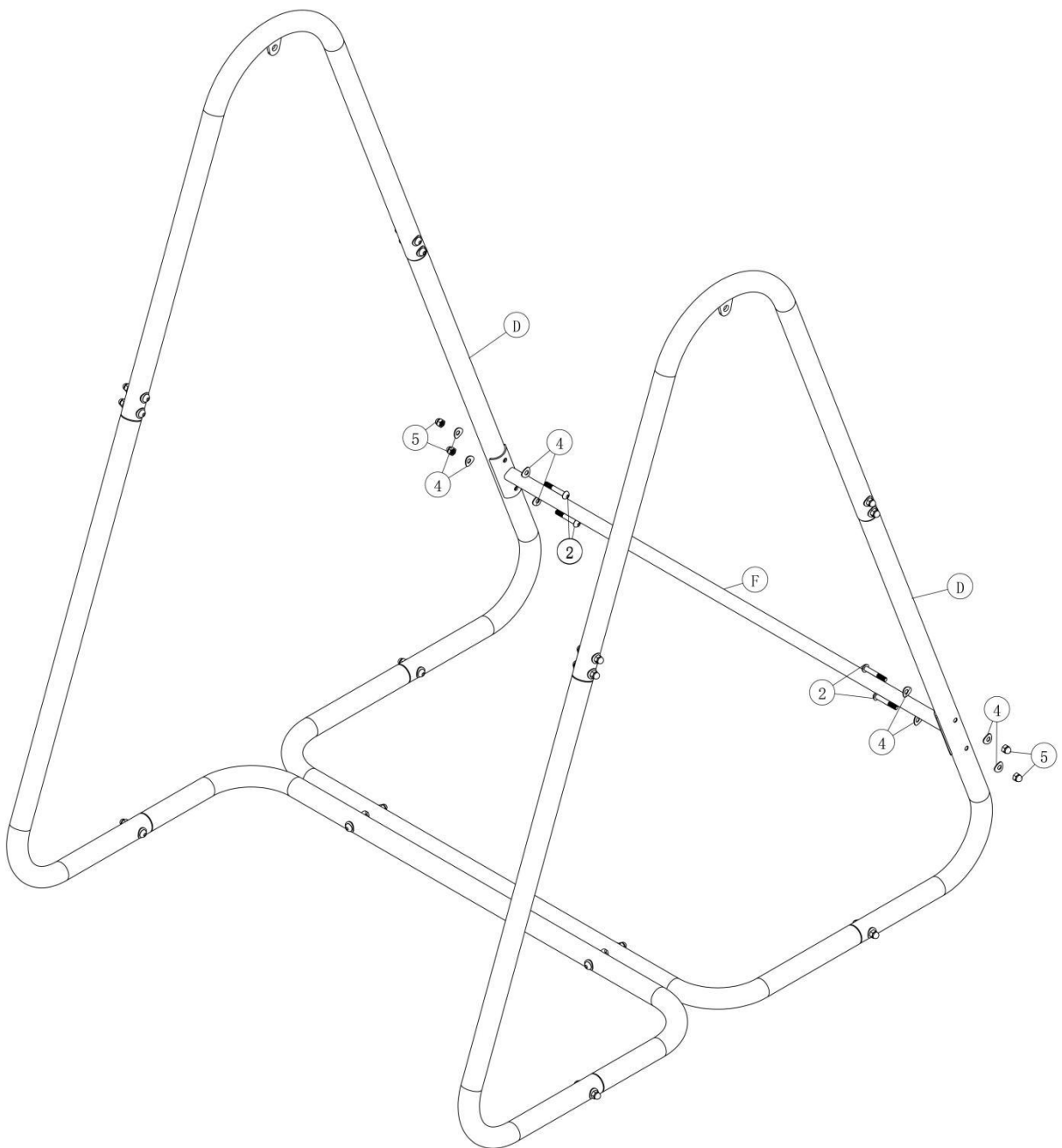

STEP 5:

Install 2 carabiners (6) into the holes of the welded clasps on each of the 2 top bends (E).

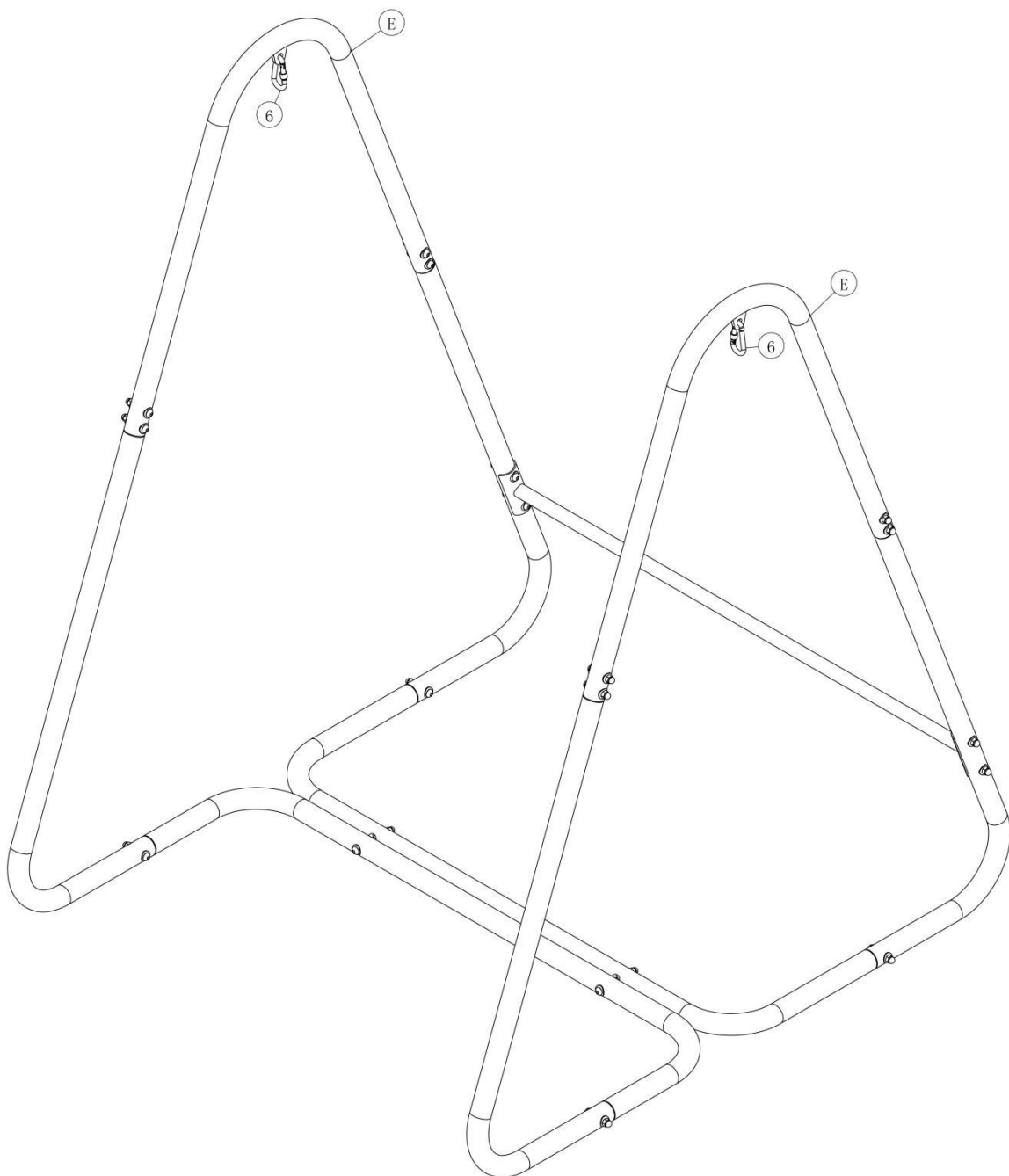

STEP 6:

Attach the O-rings on the 2 ropes of the swing seat (1) to the carabiner (6).

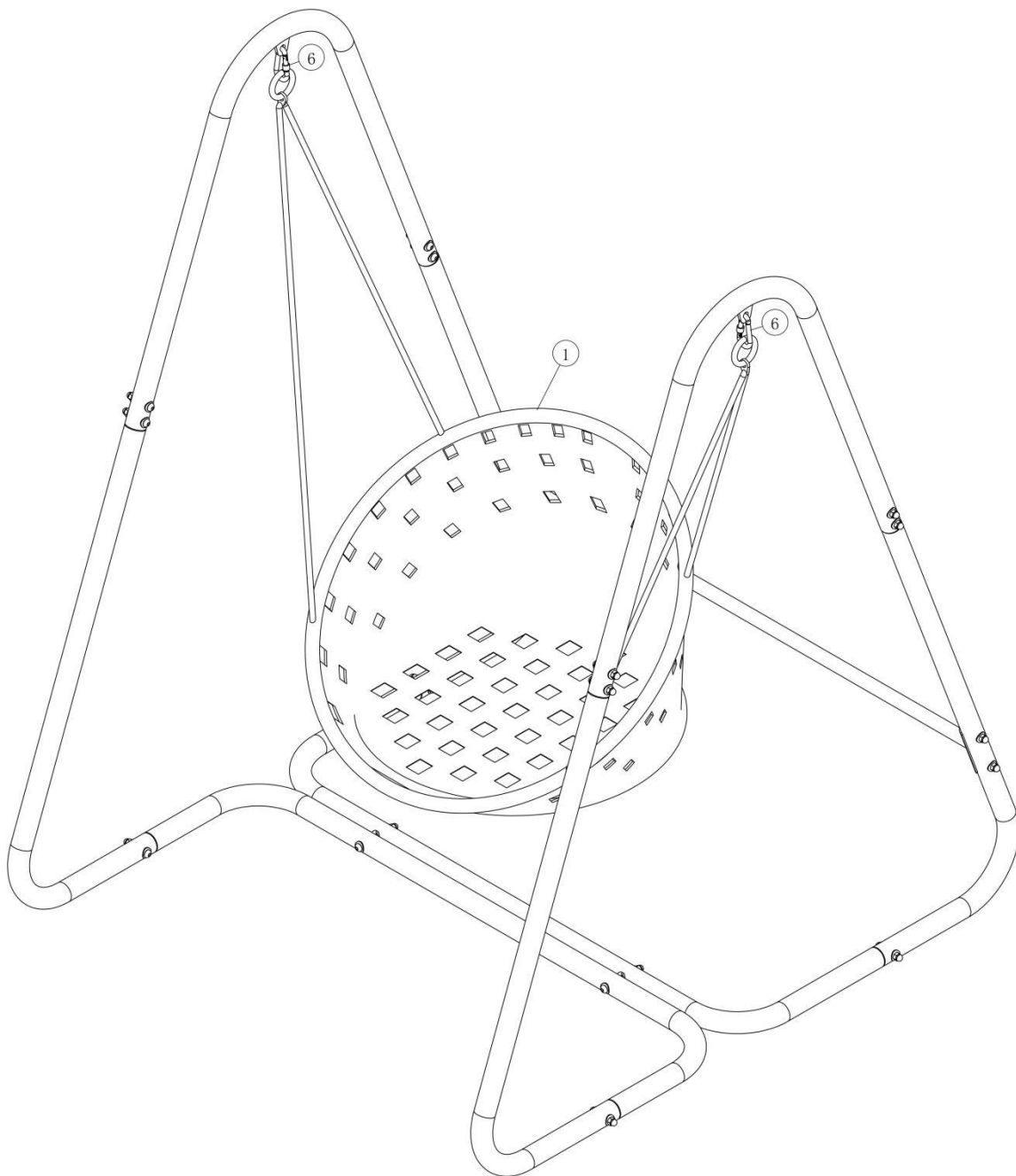

STEP 7:

Install the plastic feet (7) on the bottom tube (A) and bottom tube (B).

All assembly complete!

