

Owner Manual

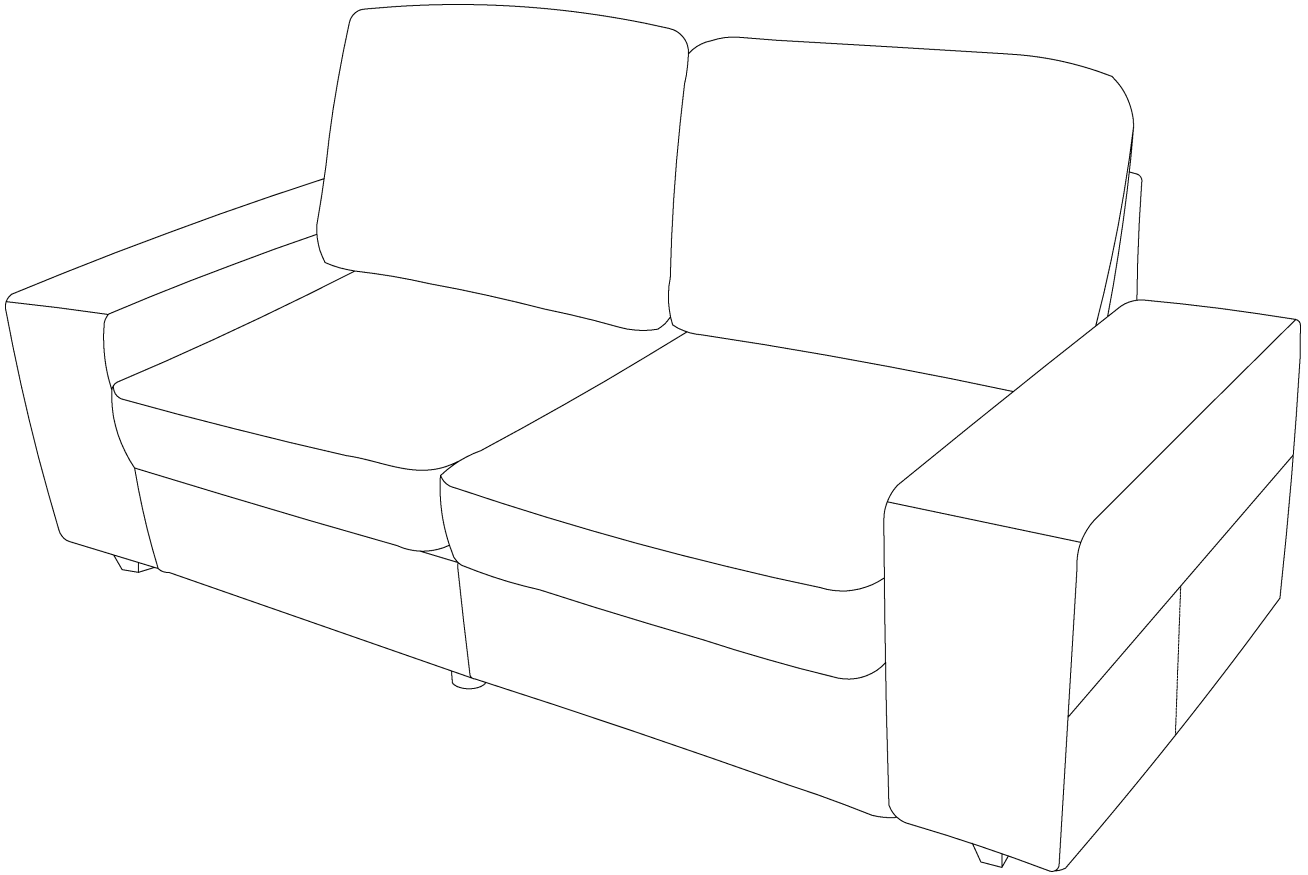

Date of Manufacture:25W01

**IF YOU PURCHASED THE SOFA ONLINE AND HAVE ANY
QUESTIONS OR CONCERNS
CONTACT US VIA EMAIL, TEXT, OR PHONE**

Matters needing attention:

- 1. To avoid loose sofa structure, please make sure to place the sofa flat. If the ground is uneven, please use a rubber pad to level it.**
- 2. Try not to step on or jump on the sofa to prevent explosion, collapse, and accelerate aging.**
- 3. The load-bearing capacity of the sofa armrest is different from that of the seat cushion, please do not sit on the sofa armrest.**
- 4. Do not expose the sofa directly to sunlight or close to heat sources to avoid fading.**
- 5. Do not place the sofa close to other painted furniture and walls. Keep a distance of 2-3 centimeters to avoid fabric wear.**
- 6. Sharp tools (keys, knives, etc.) and animal claws can cause damage to the sofa.**
- 7. Maintain ventilation and normal indoor humidity to prevent the sofa from getting damp and moldy.**

Maintenance information:

Fabric fibers are prone to retaining dust and dirt. First, pat with a dry towel to remove the floating dust, then wipe the cloth surface with a wet towel, or use a soft bristled brush or vacuum cleaner. If a vacuum cleaner is used, the dust removal effect will be better, but do not use a suction brush to prevent damage to the weaving threads on the textile fabric. Avoid excessive suction, otherwise it may cause the weaving threads to be torn. If there are stains on the fixed fabric cover, a special cleaning agent can be used. Dip a clean soft cloth in a small amount of the agent and repeatedly wipe the dirty area until the stains are removed. To avoid leaving marks, it is best to start from the outer edge of the stain. The detachable sofa cover can be dry cleaned and washed with water, and can be washed with regular detergent, but cannot be machine washed. When using, avoid sitting on the sofa with sweat stains, water stains, and mud dust to ensure the longevity of the sofa.

PART LIST

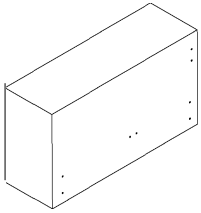
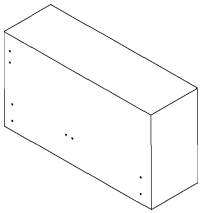
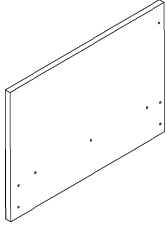
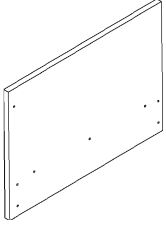
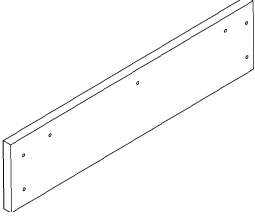
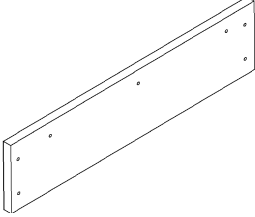
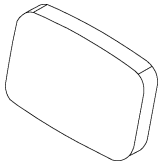
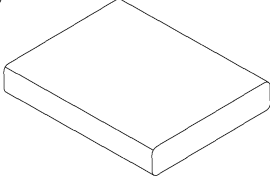
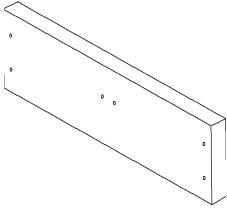
<p>A</p> 	<p>B</p> 	<p>C</p> 
<p>1PC</p>	<p>1PC</p>	<p>1PC</p>
<p>D</p> 	<p>E</p> 	<p>F</p> 
<p>1PC</p>	<p>1PC</p>	<p>1PC</p>
<p>G</p> 	<p>H</p> 	<p>I</p> 
<p>2PCS</p>	<p>2PCS</p>	<p>1PC</p>

ACCESSORY

J

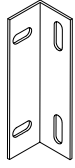

8PCS

K

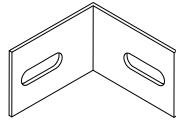

2PCS

L

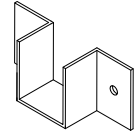

4PCS

M

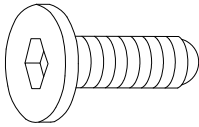

M6x18mm

46PCS

N

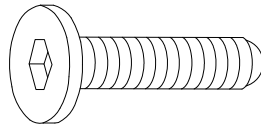

M6x40mm

12PCS

O



58PCS

P

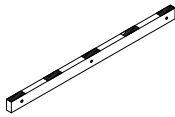

4PCS

Q



2PCS

R

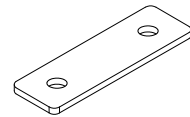

4PCS

S

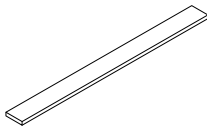

68.3cm

10PCS

T

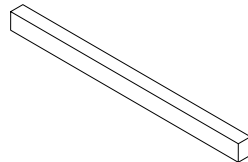

80cm

2PCS

U

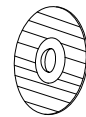

6PCS

V



2PCS

W

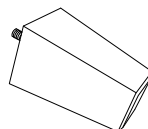

4PCS

1.

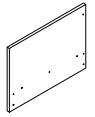
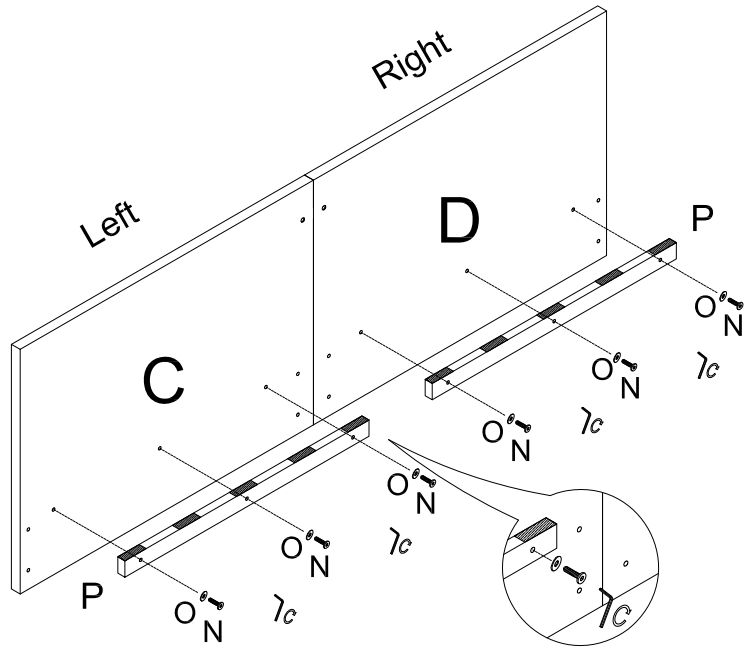

C*1PC

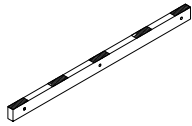

P*2PCS

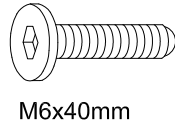

N*6PCS
M6x40mm

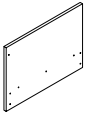

D*1PC



O*6PCS

2.

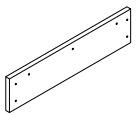
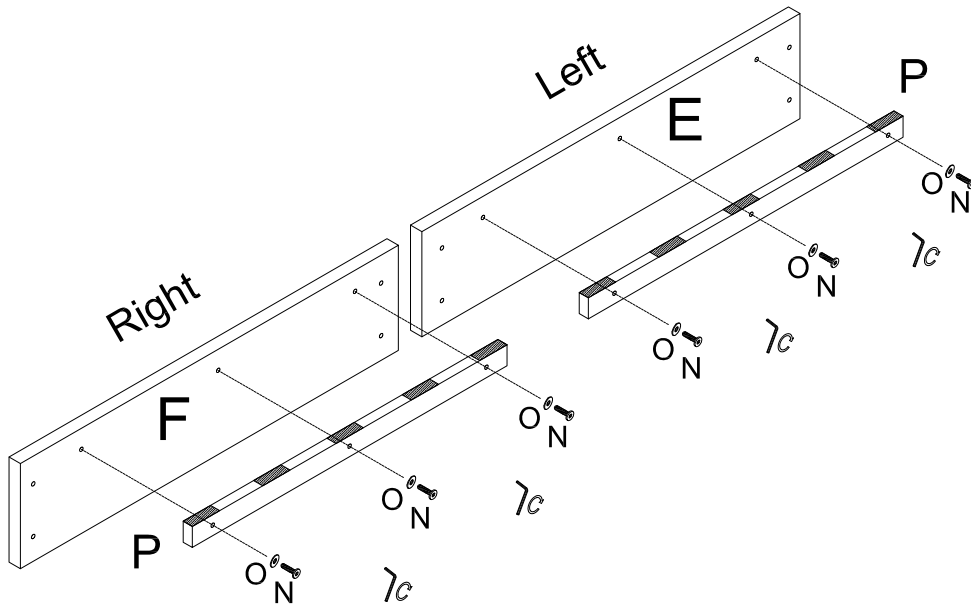

E*1PC

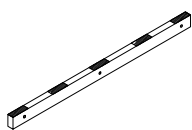

P*2PCS



O*6PCS

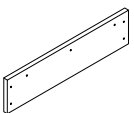

F*1PC

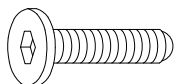

M6x40mm

N*6PCS

3.

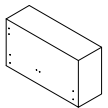
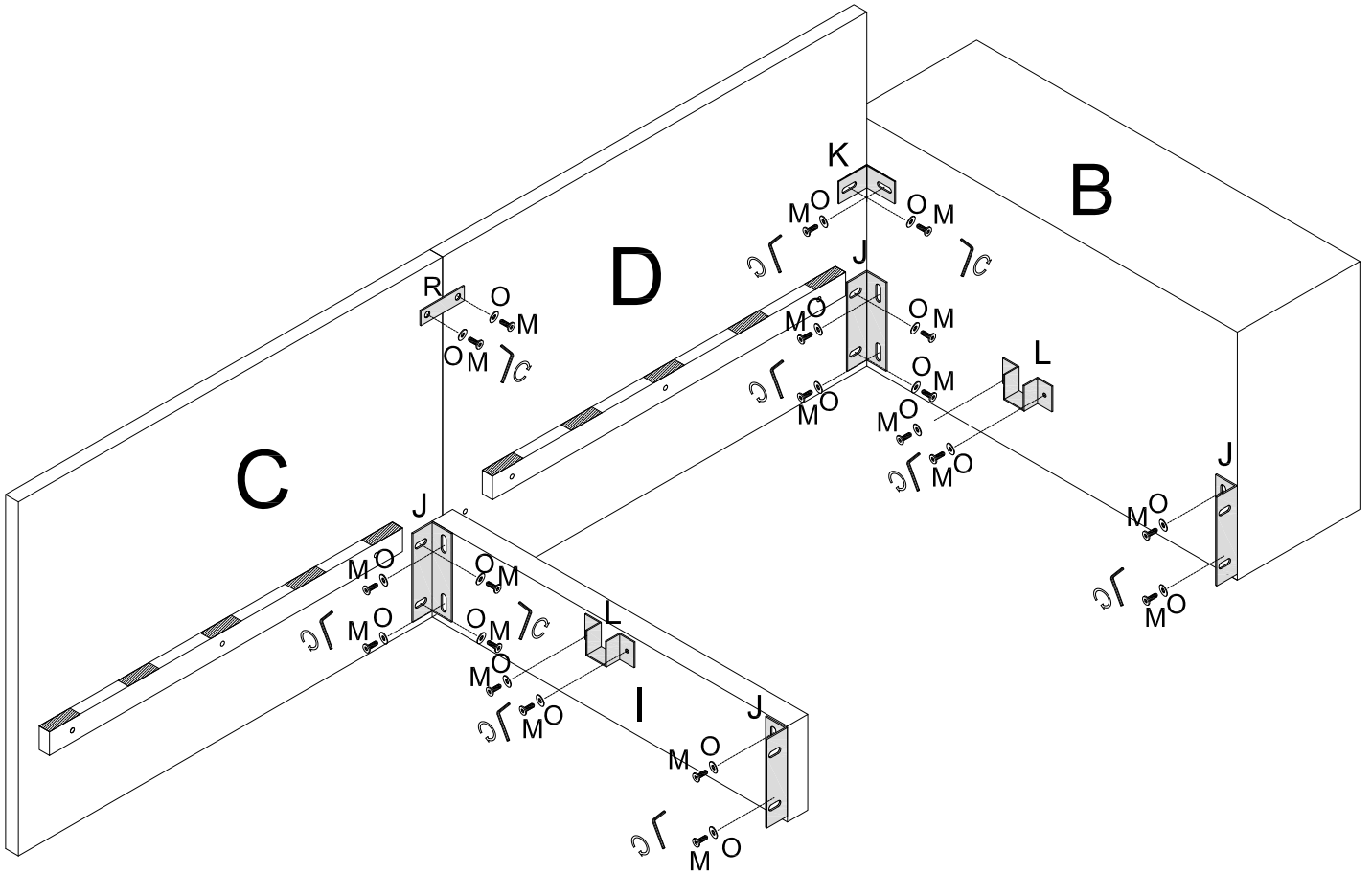

B*1PC



J*4PCS



L*2PCS



O*20PCS

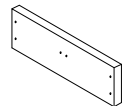

I*1PC

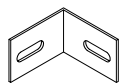

K*1PC

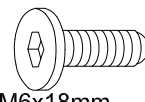

M6x18mm

M*20PCS

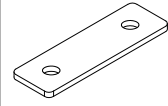

R*1PC

4.

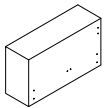
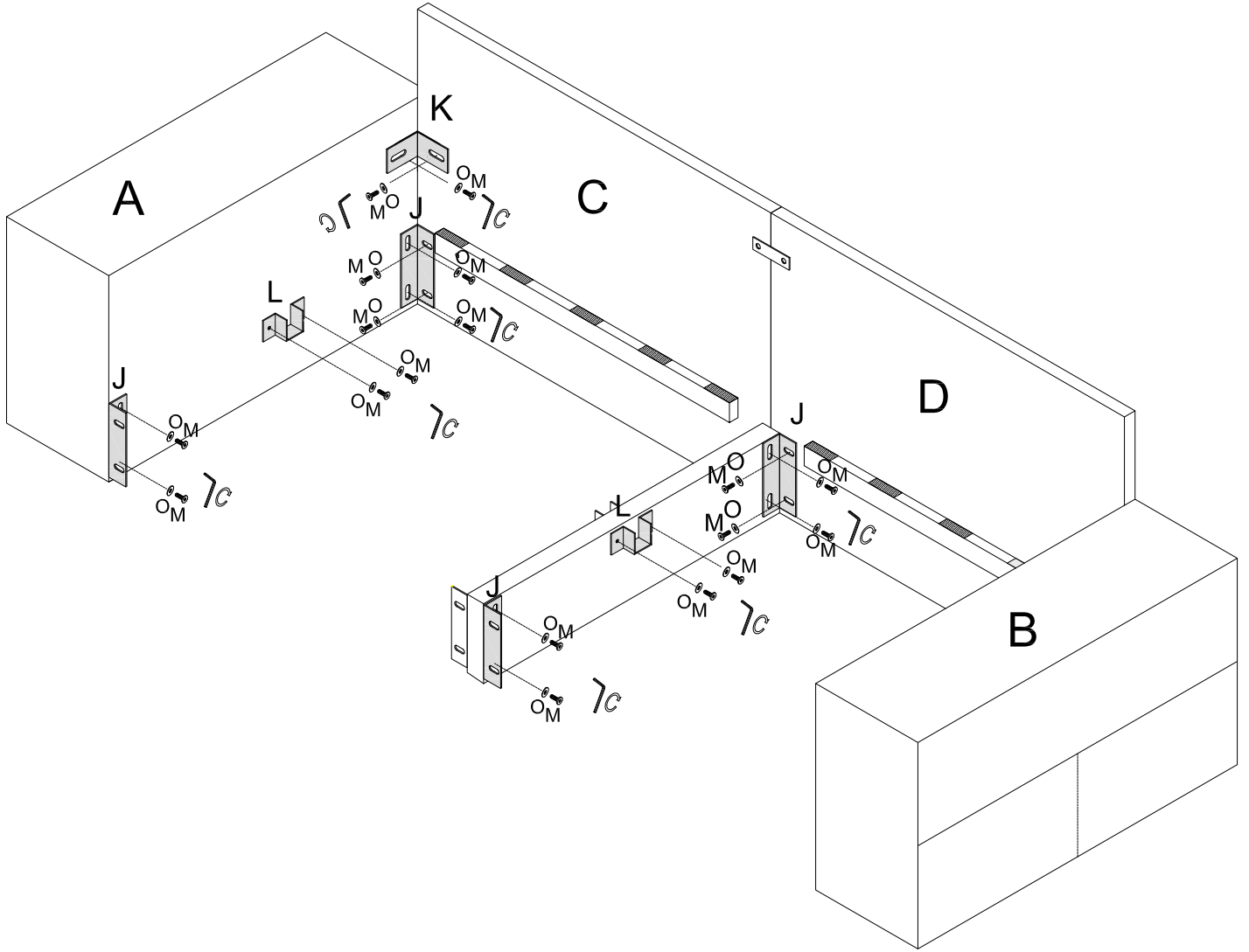

A*1PC

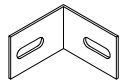

K*1PC

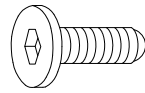

M*18PCS

M6x18mm



J*4PCS



L*2PCS



O*18PCS

5.

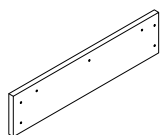
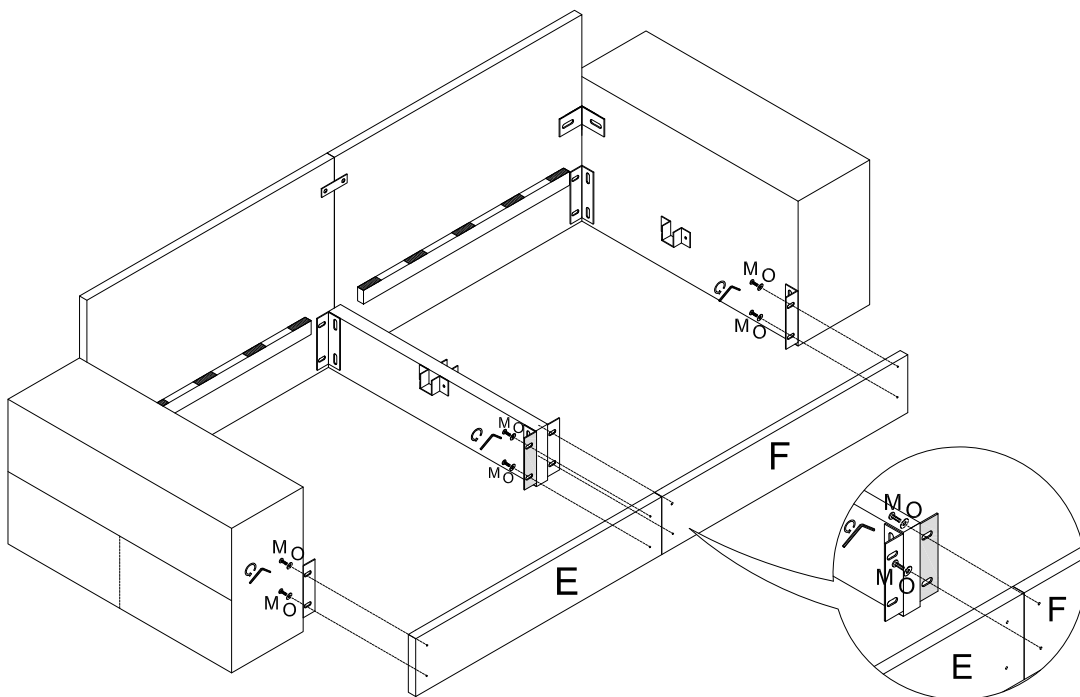

E*1PC

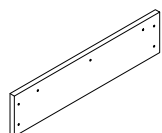

F*1PC

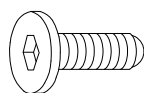

M6x18mm

M*8PCS



O*8PCS

6.

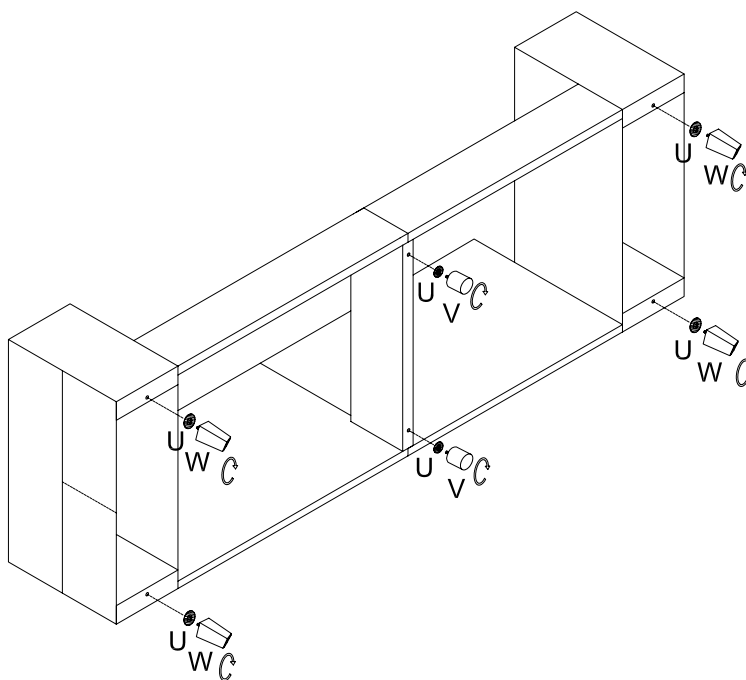

V*2PCS



U*6PCS

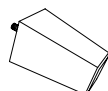

W*4PCS

7.

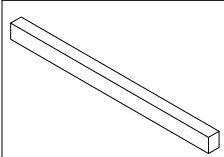
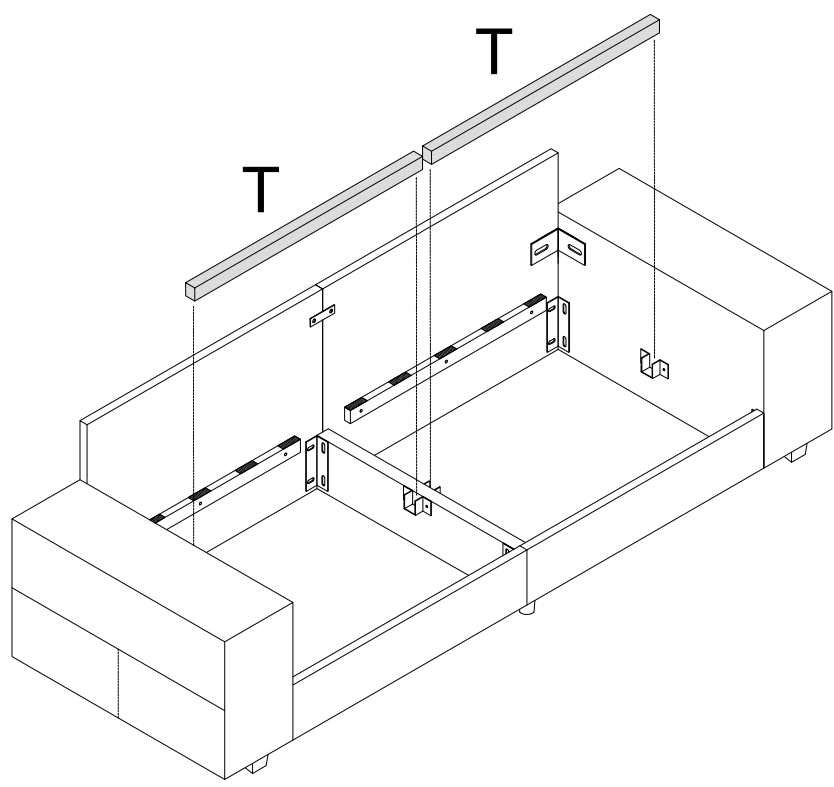

T*2PCS

8.

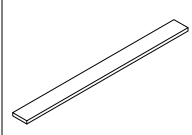
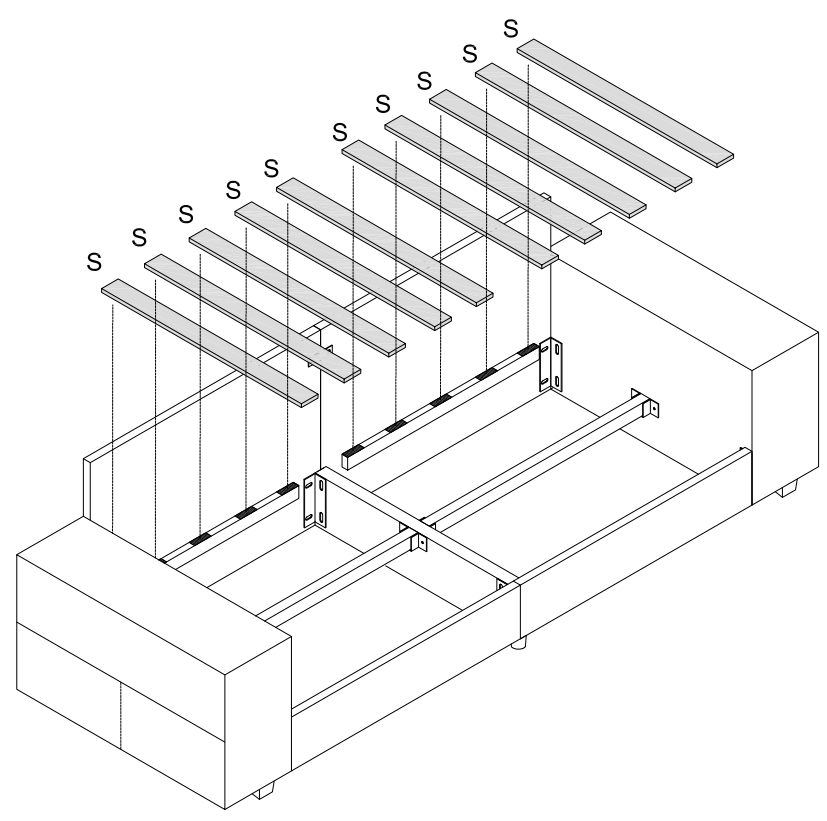

S*10PCS

9.

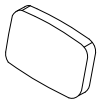
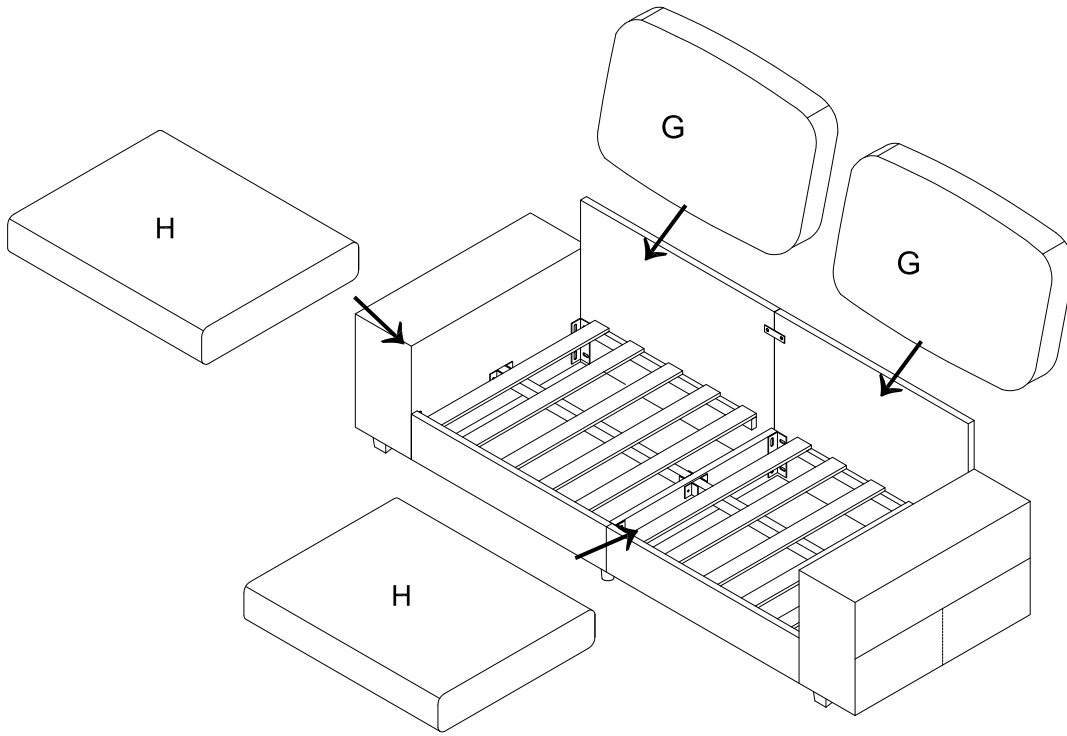

G*2PCS

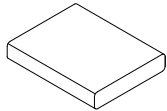

H*2PCS

10.Finish

