

Specifications

DESCRIPTION

- Brass construction
- Flexible supply lines with 3/8" or 9/16" compression fittings
- Includes Red/Blue indicators

FLOW

- Water usage is limited to these maximum flow rates as indicated by the corresponding product markings
- North America: 1.8 gpm max (6.8L/min) at 60psi
- California: 1.8 gpm max (6.8L/min) at 60psi

CARTRIDGE

- Ceramic disk cartridge

STANDARDS

- Certified to CUPC
- Certified to AB1953
- Certified to NSF/ANSI 61
- ADA  for lever handle

WARRANTY

- Lifetime limited warranty against leaks, drips and finish defects to the original consumer purchaser
- 5 year warranty if used in commercial installations

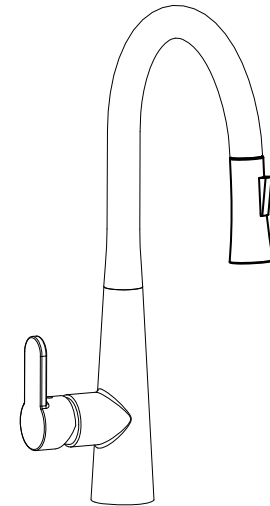

Pull out Kitchen Faucet

NOTE: THIS FAUCET IS DESIGNED TO BE INSTALLED THRU 1 HOLE, Φ 1-3/8" MIN.



Faucet part	Guarantee	Damage	Solution
Body:	10 years guarantee	Burst, deformation, leakage, dents	Replace a new one
Cartridge:	5 years guarantee	Leakage, uneven hot and cold water	Replace new cartridge
Supply hose:	5 years guarantee, with insurance	Deformation, burst, connector water leakage	Replace supply hose or seal ring of the connector
Aerator:	1 year guarantee	Leakage, no water or litter water	Clean or replace the mesh
O-ring:	1 year guarantee	Leakage	Replace a new one

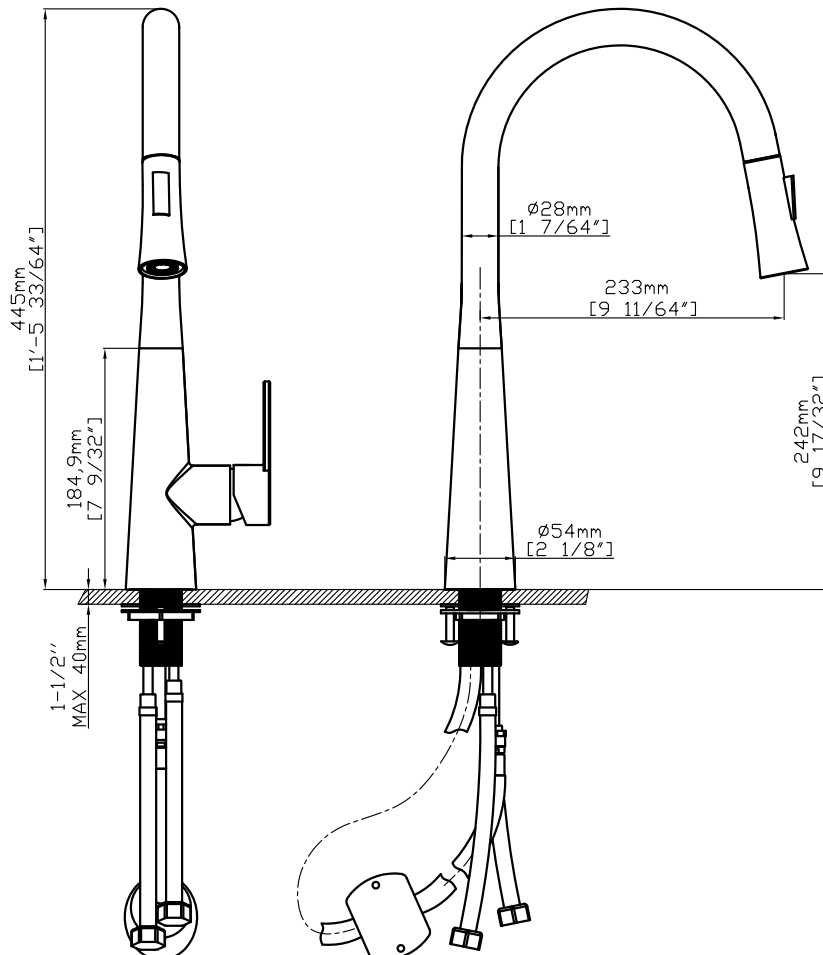

CRITICAL DIMENSIONS

Pull out Kitchen Faucet Installation

INSTALLATION MANUAL Tools You Will Need :

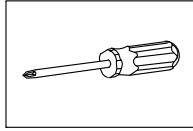
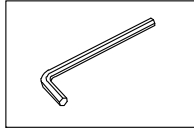
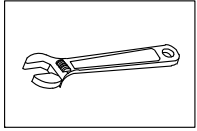

Adjustable wrench Hexagon wrench Phillips Screwdriver

Notes before installation :

1. Please check that all components are present.
2. Before installation ensure that all feed lines are clear of debris and on/off valve is present.
3. Ensure water pressure is between 20-125 PSI (includes combination of hot and cold feed lines).
4. Pictures in the manual are general in content and may not represent exactly your purchased faucet. If you are having difficulties please contact a professional plumber.
5. If you will be away from home for an extended period you should shut off the main water supply.

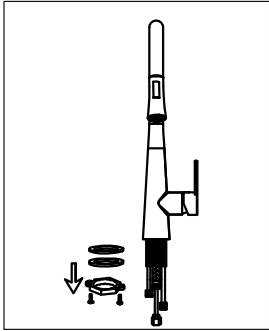

1. Remove locking-nut, metal and rubber washer and hose connector if installed.

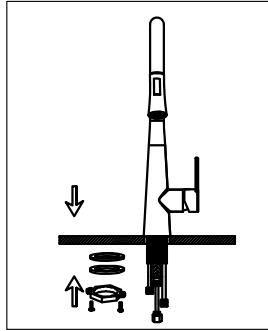

2. Install faucet through center hole, re-install rubber and metal washer followed by the lock-nut. Re-install hose connector if removed insuring small rubber washer is also installed. Using a screwdriver tighten the lock-nut screws so that the faucet is secure and will not twist.

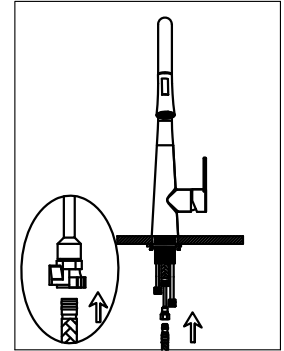

3. Push pull-out hose in to the hose connector until you hear a click sound.

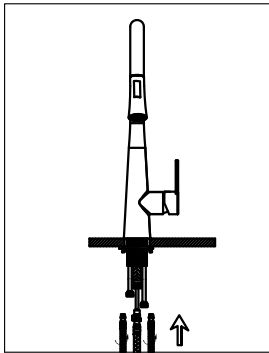

4. Screw and tighten the hot and cold flexible lines to the corresponding faucet connectors. Using a wrench ensure that the copper faucets lines are stable as you tighten the braided feed lines.

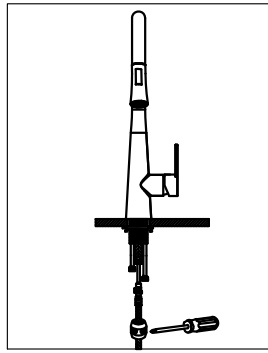

5. Proper installation of the hose weight kit will ensure that the spray head retracts smoothly. On the spray side of the hose, measure 15" down from the body of the faucet. Install the hose weight kit at this point. Pull out on the spray head. It should move easily and retract smoothly. Reposition the hose weight kit as necessary.

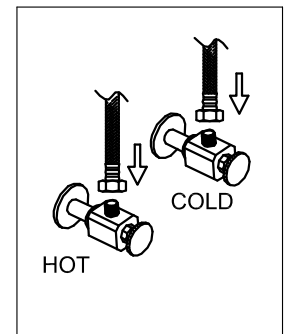

6. Attach flexible hose to water supply.

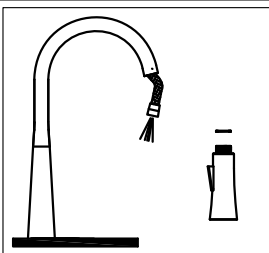

7. Hold on to the spray-head hose, unscrew spray head and remove it along with the rubber washer. Turn on the faucet to flush the hose and feed line for 1-minute to flush debris. Turn off faucet and re-install the rubber washer and spray head.

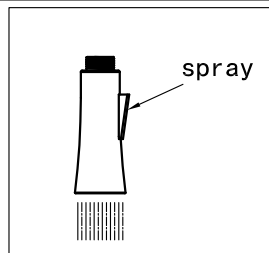

8. Turn the faucet on and press the top of the spray head button to change to Spray.

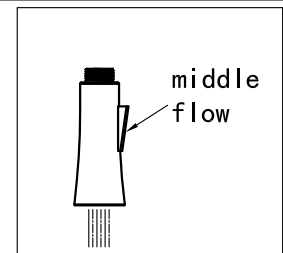

9. Turn the faucet on and press the bottom of the spray head button to change to stream.