



33 35TH STREET, INDUSTRY CITY BLDG.5, A405, BROOKLYN, NY 11232
T 212.355.0625 F 212.355.0628 WWW.OASIQ.COM



200-LCS Short Arm Lounge Chair

W 29 3/4" D 36 3/8" H 29 1/4"

AH 25 1/4" SH 9" OSH 13"

49.19 lbs

Teak & black PP webbing

Cushions: 200-LCS-X

Seat cushion: L 26 1/2" W 29 3/4" H 4"

Pillow: L 20" W 20"

FABRIC AVAILABLE FOR ASTOR, HAMILTON, MADISON, DELANCEY & LIMITED COLLECTIONS



Canvas Natural 5404-0000

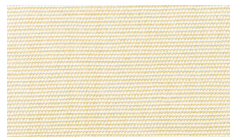

Canvas Vellum 5498-0000

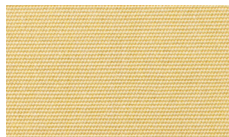

Canvas Wheat 5414-0000

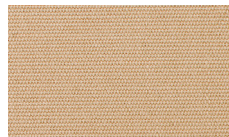

Canvas Camel 5468-0000



Canvas Granite 5402-0000

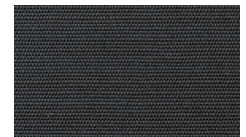

Canvas Black 5408-0000



Canvas Buttercup 5438-0000

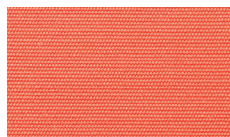

Canvas Melon 5415-0000

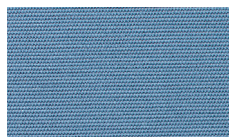

Canvas Sapphire Blue 5452-0000



Canvas Sky Blue 5424-0000

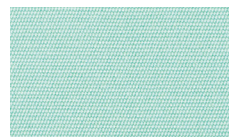

Canvas Glacier 5428-0000

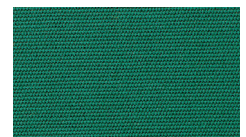

Canvas Forest Green 5446-0000

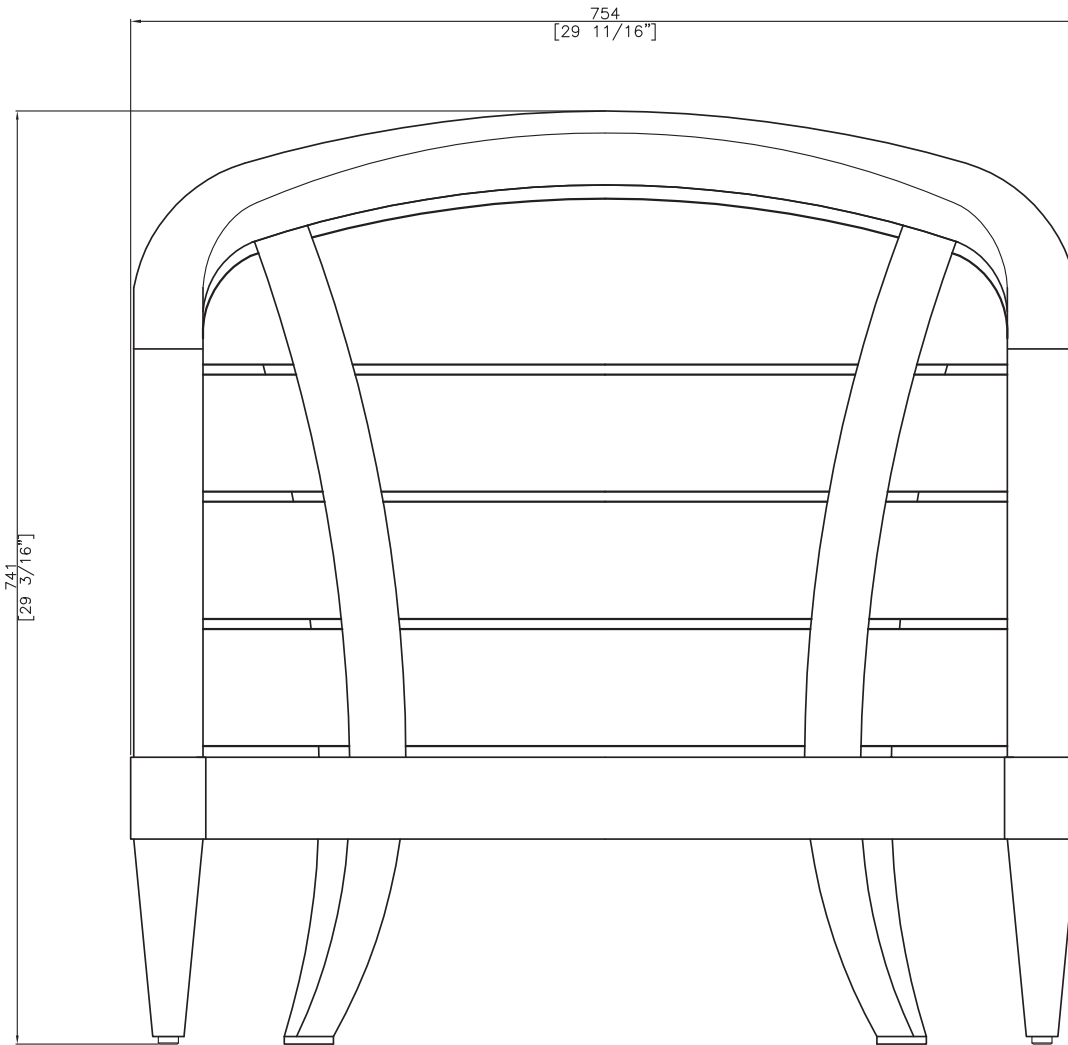

FRONT

EF

OASIQ

DWG.NO: FAEDG0002T-3

TITLE : FRONT

DIM EXT: 754x923.6x741MM.

MATERIAL: TAEK

DRAWN BY : AEKCHAI

FINISH DATE :26-12-06	AEK
BEGIN DATE : 18-01-06	AEK

SCALE : 1:1

P.5

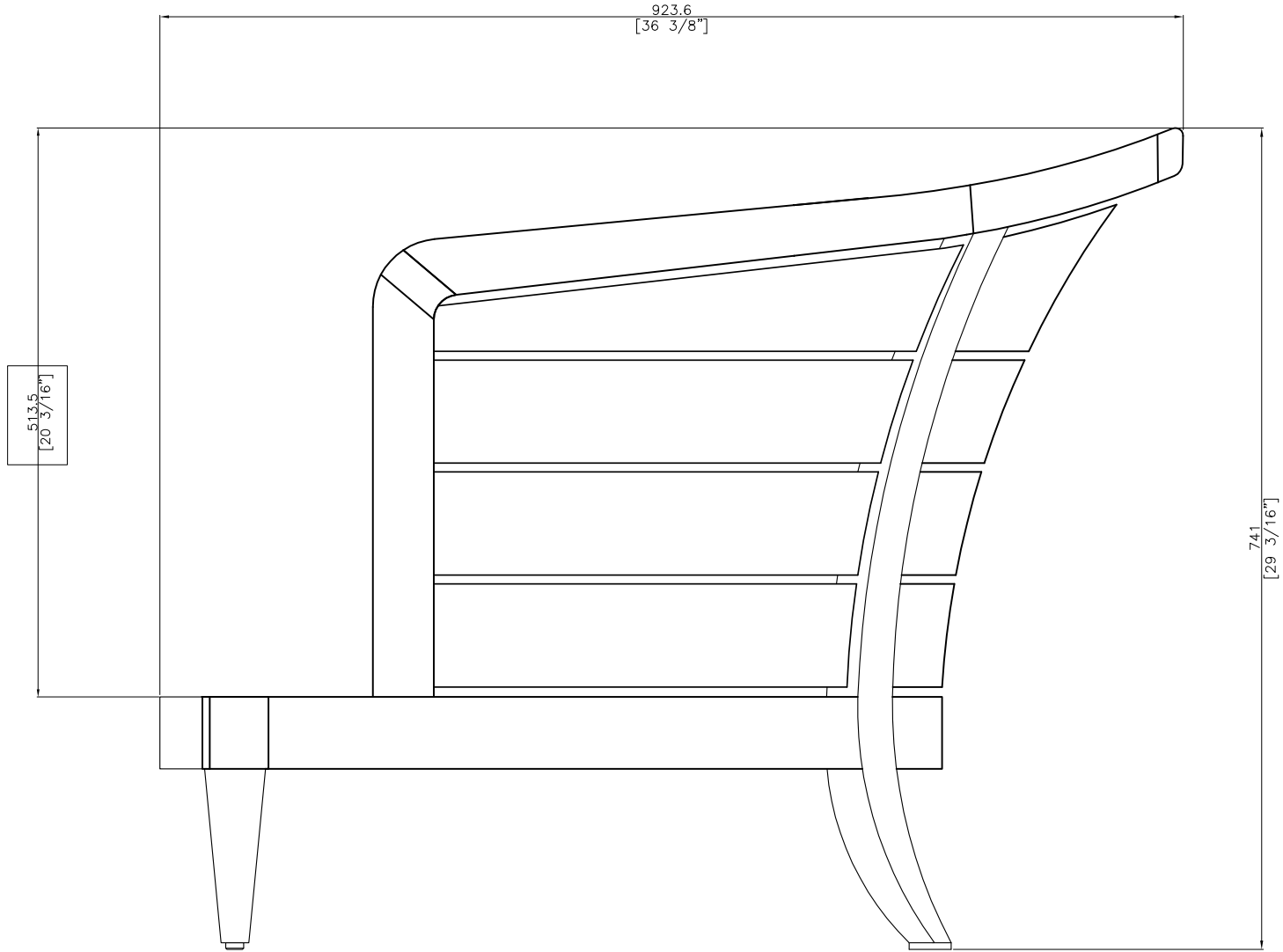

SIDE

ES

OASIQ

DWG.NO: FAEDG0002T-3

TITLE : SIDE

DIM EXT: 754x923.6x741MM.

MATERIAL: TEAK

DRAWN BY : AEKCHAI

FINISH DATE : 26-12-06	AEK
BEGIN DATE : 18-01-06	AEK

SCALE : 1:1

P.6

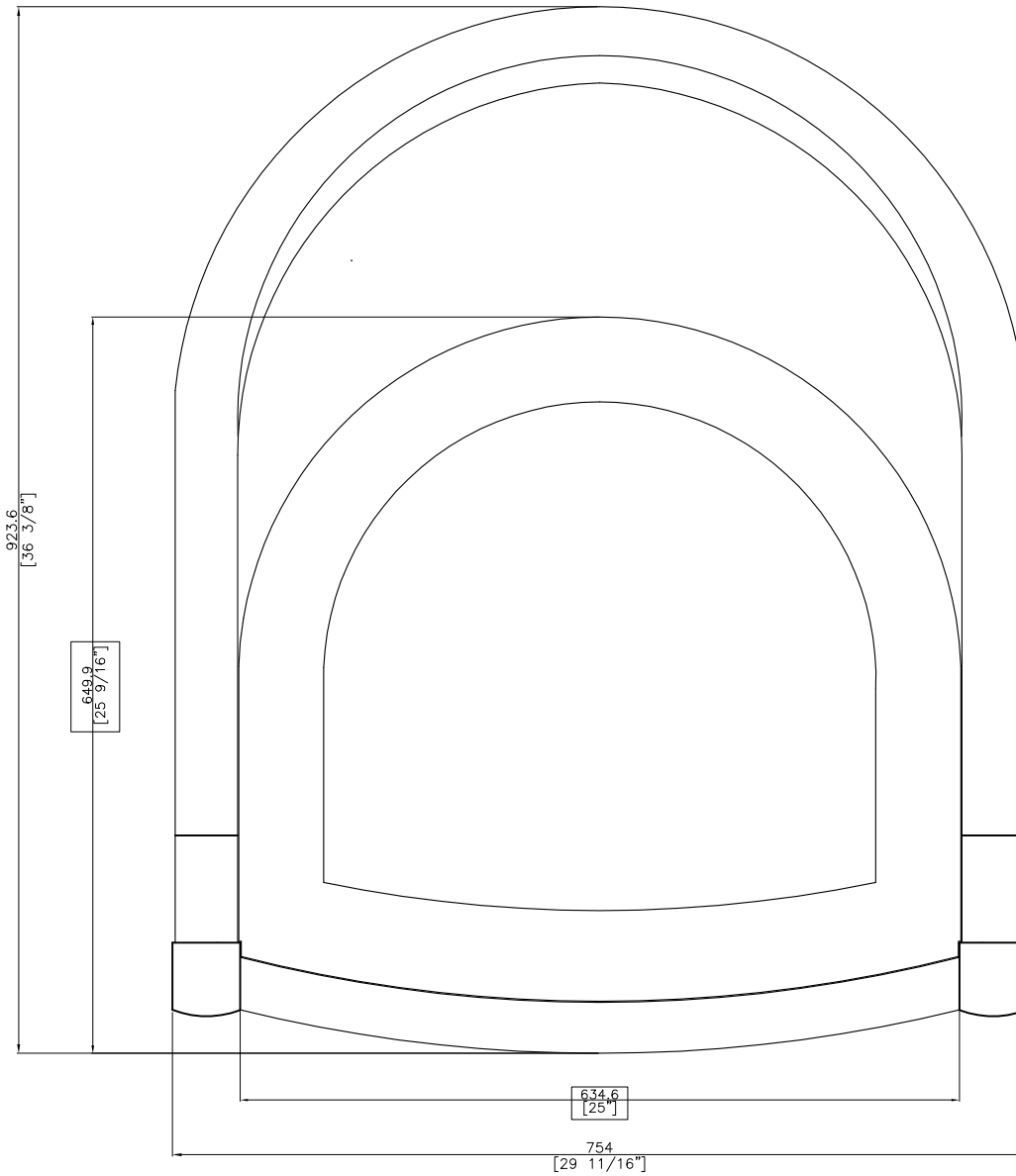

TOP

ET

OASIQ

DWG.NO: FAEDG0002T-3

TITLE : TOP

DIM EXT: 754x923.6x741MM.

MATERIAL: TAEK

DRAWN BY : AEKCHAI

FINISH DATE : 6-03-07	AEK
BEGIN DATE : 18-01-06	AEK

SCALE : 1:1

P.4