

# Assembly & Instruction Manual

SKU:800-206

# Grill gazebo

## Installation Guide



Version20230309

Save this manual for future reference

# INTRODUCTION

Thank you for purchasing Aoodor's Grills gazebo! We hope you will find joy in our product for many years to come.

To ensure your personal safety during installation and to get the most out of your investment, please read this entire manual before beginning the installation process. If you feel that this process is too difficult to do on your own, we advise that you seek assistance from a local building or home improvement contractor.

**!** **WARNING** Improper installation and operation of your gazebo can result in severe personal injury as well as product failure not covered by warranty. Please follow all instructions carefully or contact technical support for assistance.

We believe that installation can be a simple, streamlined process if you follow the instructions in this manual. Please contact our customer support line for help any step of the way. If you need assistance with assembly, have missing or defective parts, or any other issues, please email us at [customerservice@aoodor.com](mailto:customerservice@aoodor.com)

## **!** SAFETY INFORMATION

Please read and understand this entire manual before attempting.

Three people are need for assembly.

Maximum load for the roof hook: 50 lbs.

Estimated assembly time:1.5hours.

## PREPARTION

Before beginning assembly of product, make sure all parts are present. Compare parts with package contents list and hardware contents list. If any part is missing or damaged, do not attempt to assemble the product.

**Product is NOT INTENDED for the following:**

- A safety barrier to prevent unsupervised access to pools, hot tubs, spas or ponds.
- As load bearing support for a building, structure, heavy objects or swings.
- Used in structures that trap wind, rain or snow that would create extra load on the product.

**Accumulated snow must be removed from roof.**

**DO NOT** climb or walk on roof for any reason.

**Permanent structures may require a building permit.** As the purchaser and or installer of this product you are advised to consult local planning, zoning and building inspection departments for guidance on applicable building codes and/or zoning requirements.

**Wood is NOT flame retardant and will burn.** Grills, fire pits and chimineas are a fire hazard if placed too close to structure. Consult user's manual of the grill, fire pit or chimnea for safe distances from combustible materials.

**Wear gloves to avoid injury** from possible sharp edges of individual elements before assembly.











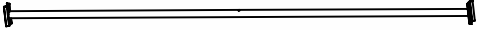
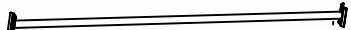
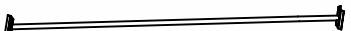

**During installation, follow all safety warnings provided with your tools and use Safety glasses.** Some structures may require two or more people to install safely.

**Check for underground utilities before digging or driving stakes into the ground!**





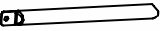
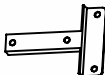

**It is important during assembly to closely follow the instructions**, complete the assembly on a solid level surface and that you follow the instruction to square up, level and anchor the structure, this will reduce the gap at wood connections during assembly.

**If you dispose of Aoodor structure:** Please disassemble and dispose of your unit so that it does not create any unreasonable hazards at the time it is discarded. Be sure to follow your local waste ordinances.

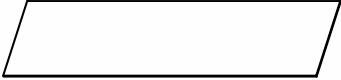
# Parts Identification

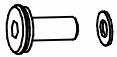
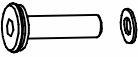
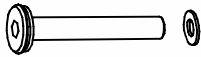
Parts	Desc	QTY	Ref No
A		2	800-206-001
A1		2	800-206-002
B		2	800-206-003
C		2	800-206-004
C1		2	800-206-005
D		1	800-206-006
D1		1	800-206-007
E		1	800-206-008
E1		1	800-206-009
F		4	800-206-010
G		4	800-206-011
H		2	800-206-012
I		2	800-206-013
J		4	800-206-014
K		8	800-206-015

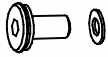
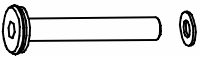
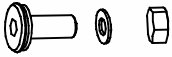

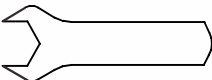

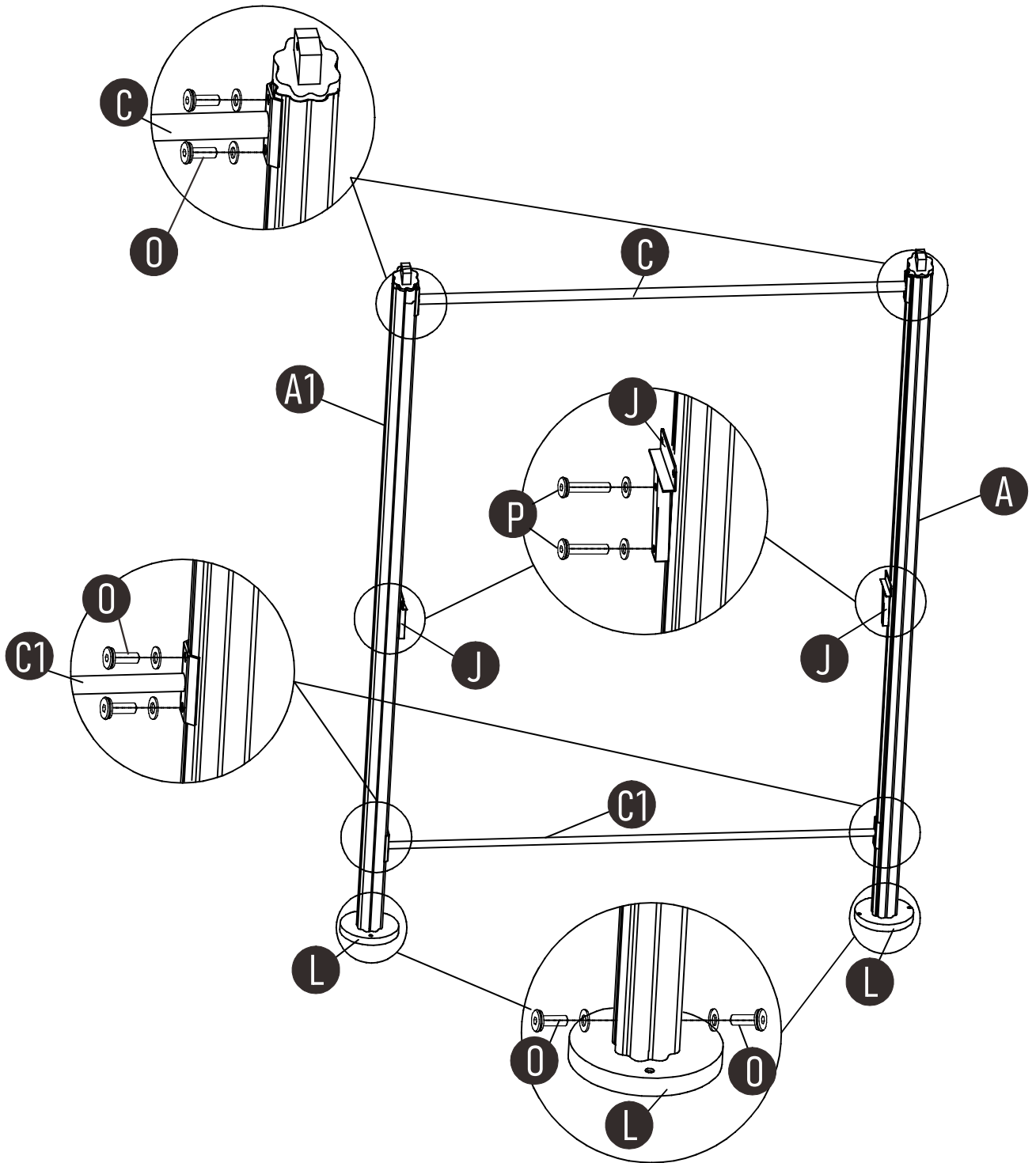

# Parts Identification

Parts	Desc	QTY	Ref No
L		4	800-206-016
M		6	800-206-017
N		8	800-206-018
O	 M6x15	52	800-206-019
P	 M6x25	8	800-206-020
Q	 M6x40	2	800-206-021
R	 M5	1	800-206-022
S	 M5x10	16	800-206-023
T	 M6x35	4	800-206-024
U	 M6x15	8	800-206-025
V		8	800-206-026
W	 M6	1	800-206-027
X		1	800-206-028

# Assembly

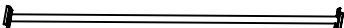
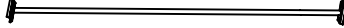
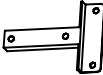
1



	Ax2PCS		A1x2PCS
	Cx2PCS		C1x2PCS
	Jx4PCS		Lx4PCS
 M6x15	Ox24PCS	 M6x25	Px8PCS

2

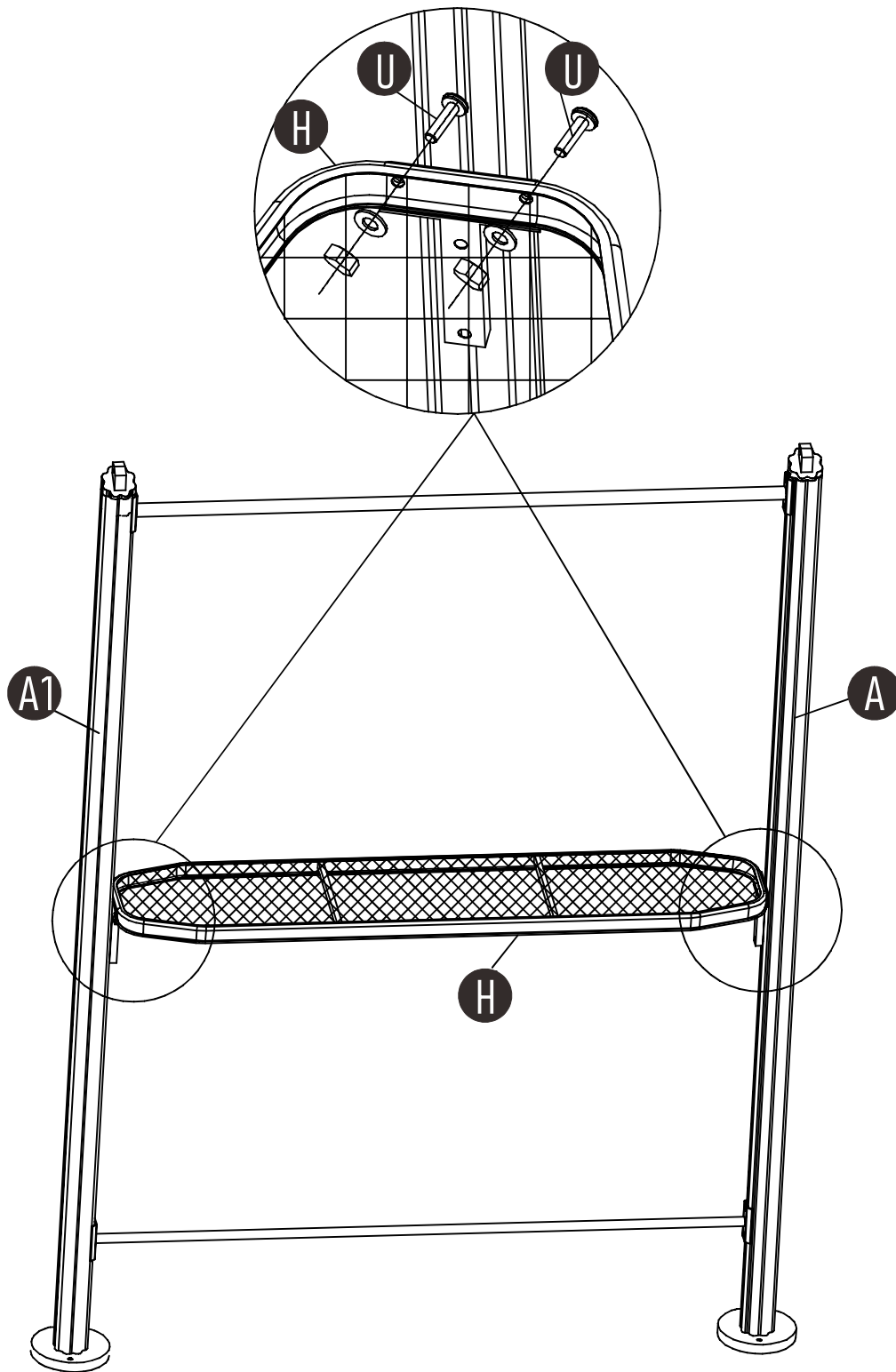

Hx2PCS

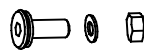

M6x15

Ux8PCS

## 3

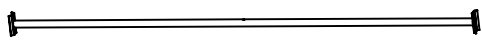
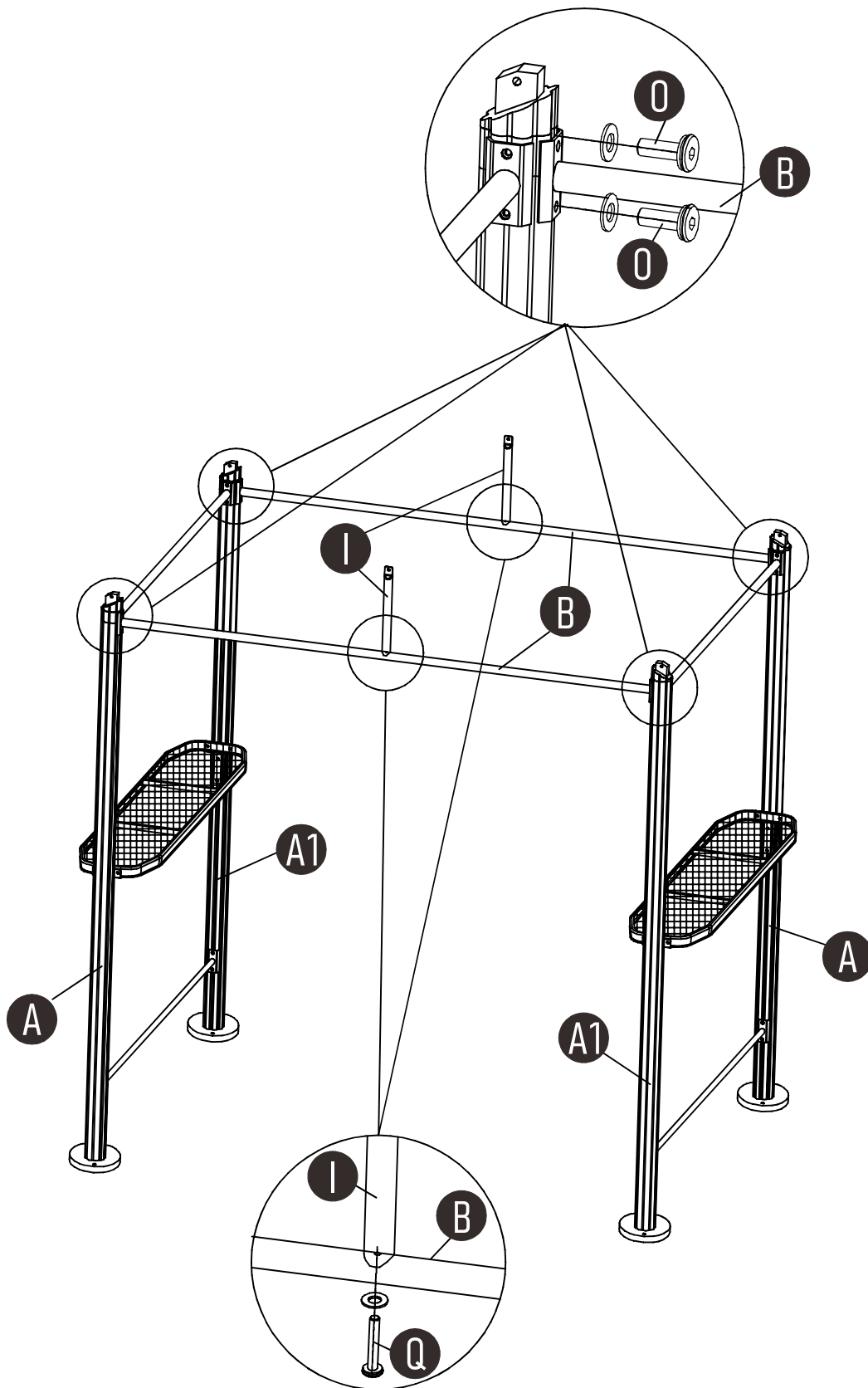

Bx2PCS

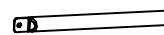

Ix2PCS

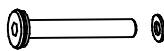

M6x40

Qx2PCS





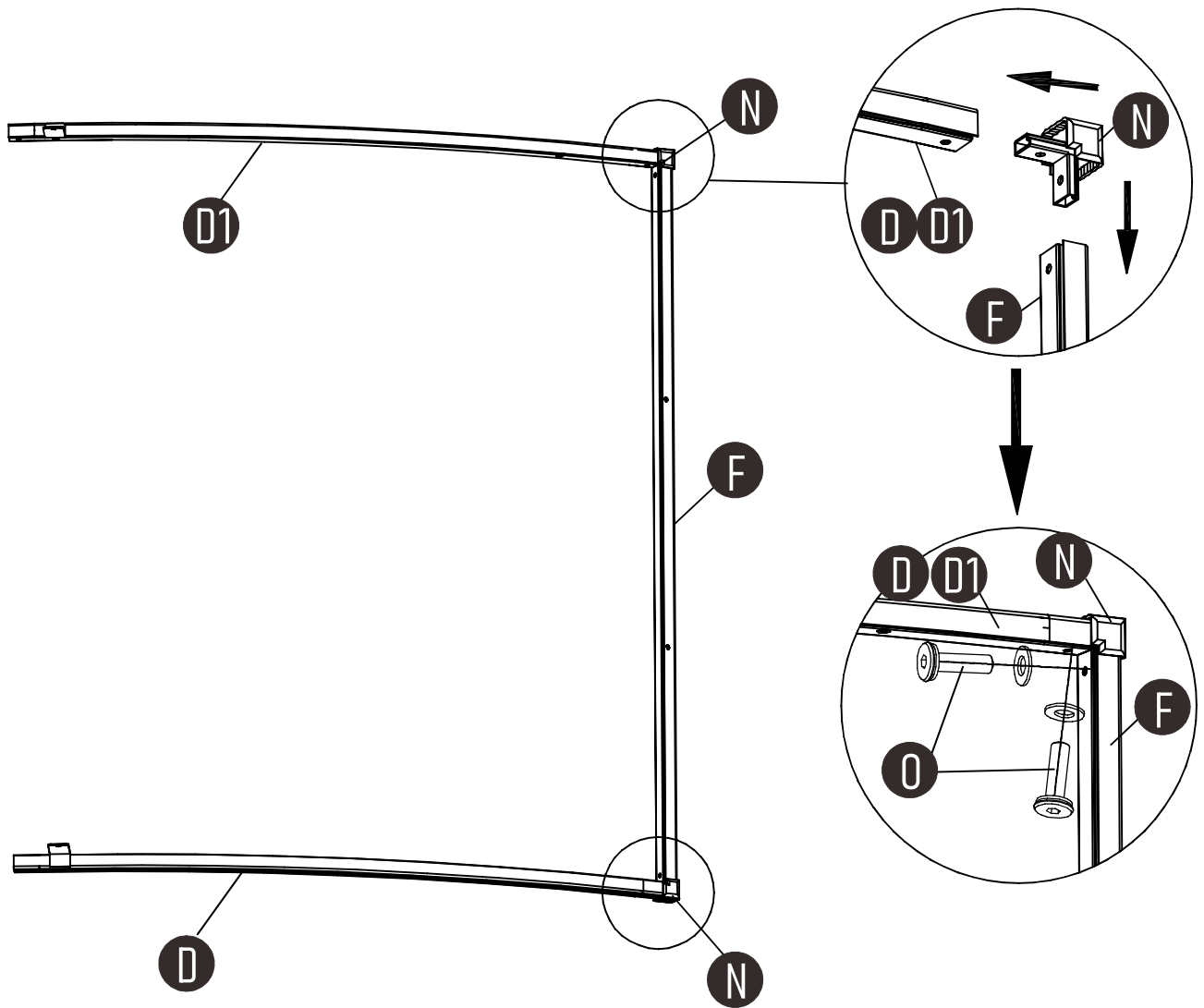

M6x15

Ox8PCS

## 4

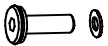

	Dx1PC		D1x1PC
	Fx1PC		Nx2PCS
 M6x15	Ox4PCS		

## 5

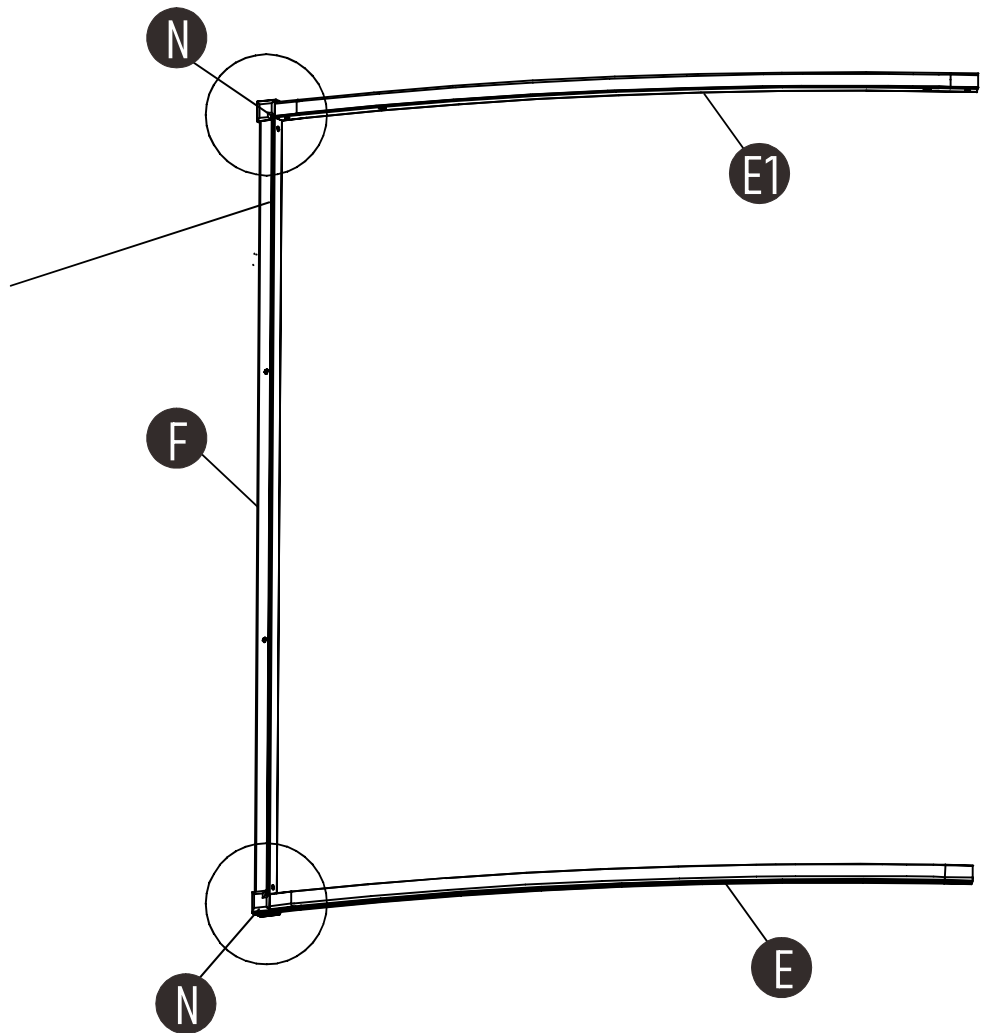
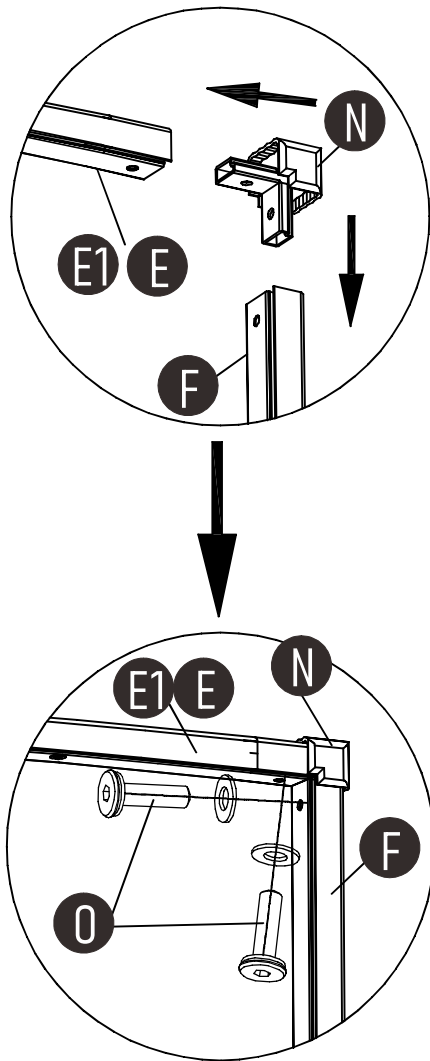

Ex1PC



E1x1PC



Fx1PC

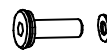

M6x15







Ox4PCS

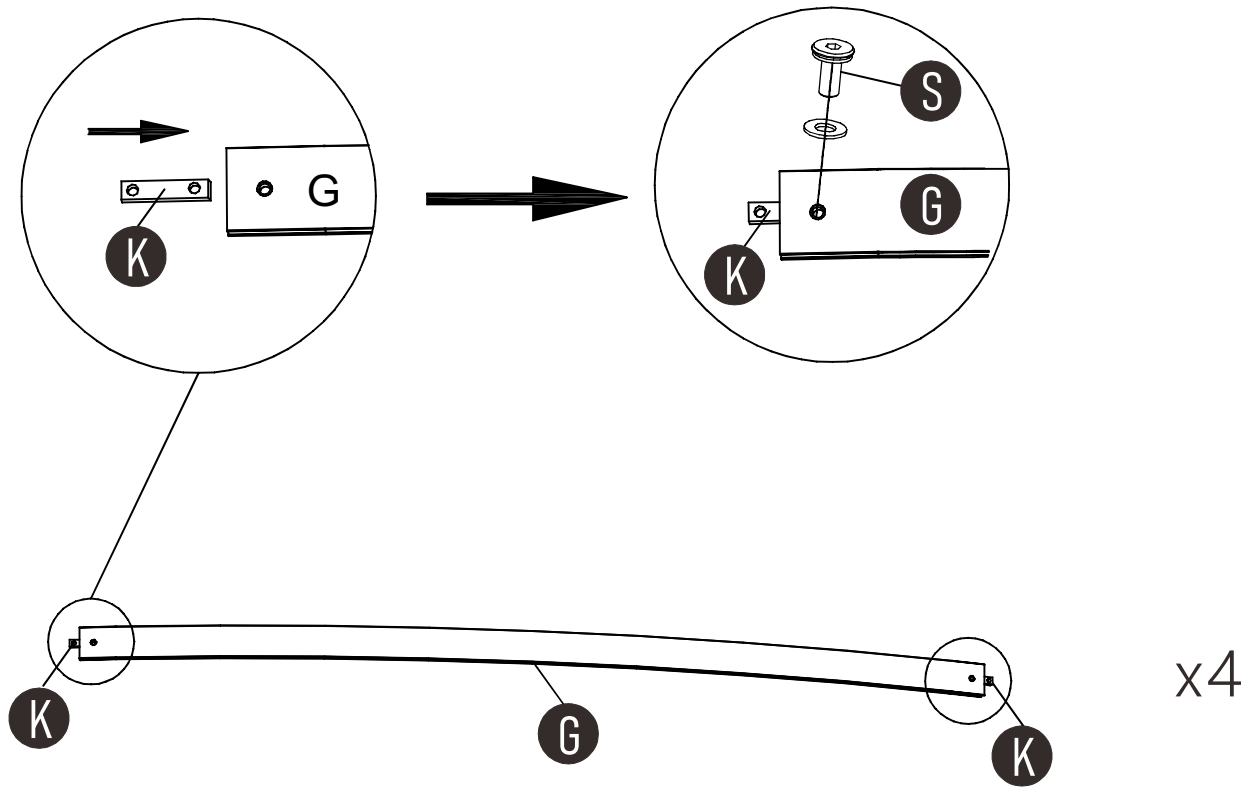
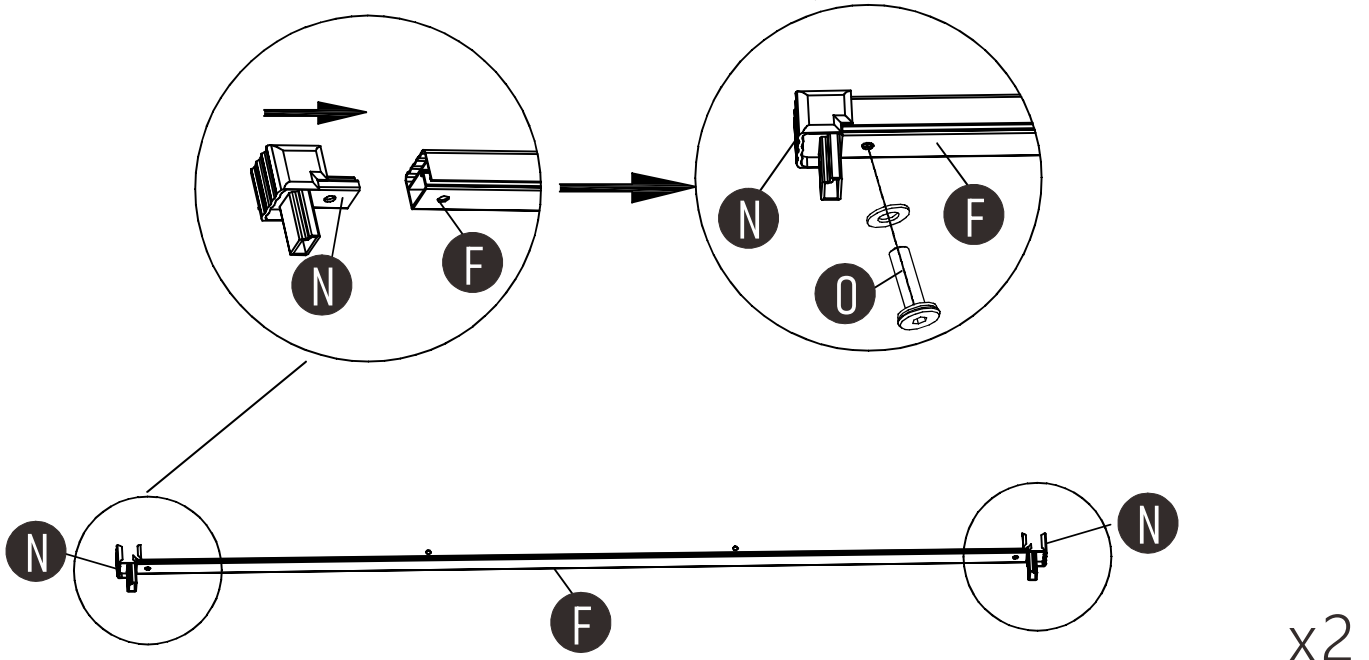

Nx2PCS

## 6

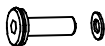

	Gx4PCS		Fx2PCS
	Kx8PCS		M6x10 Sx8PCS
	M6x15 Ox4PCS		Nx4PCS

## 7

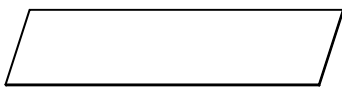
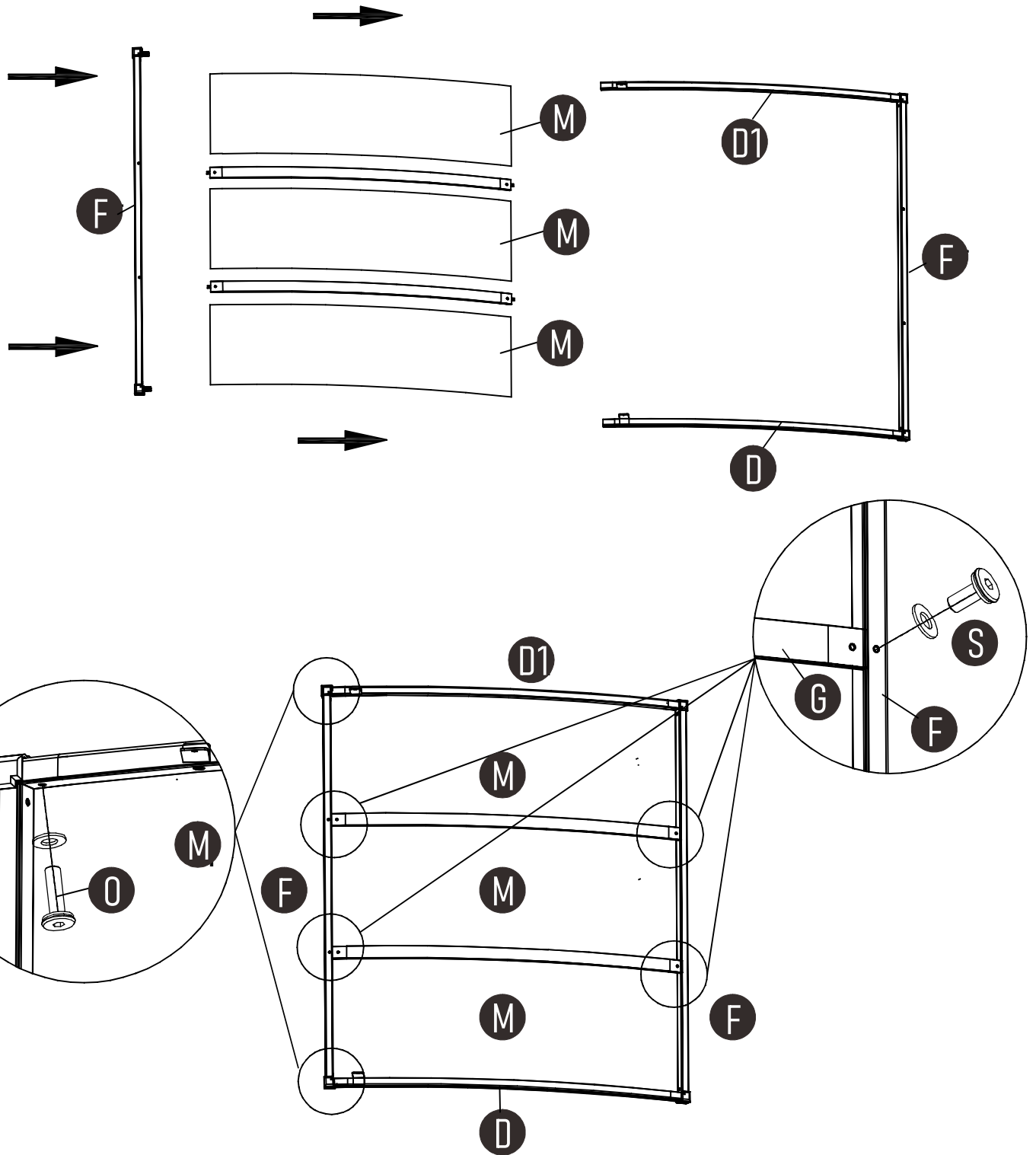

Mx3PCS

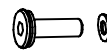

M6x15

Ox2PCS



M5x10

Sx4PCS

8

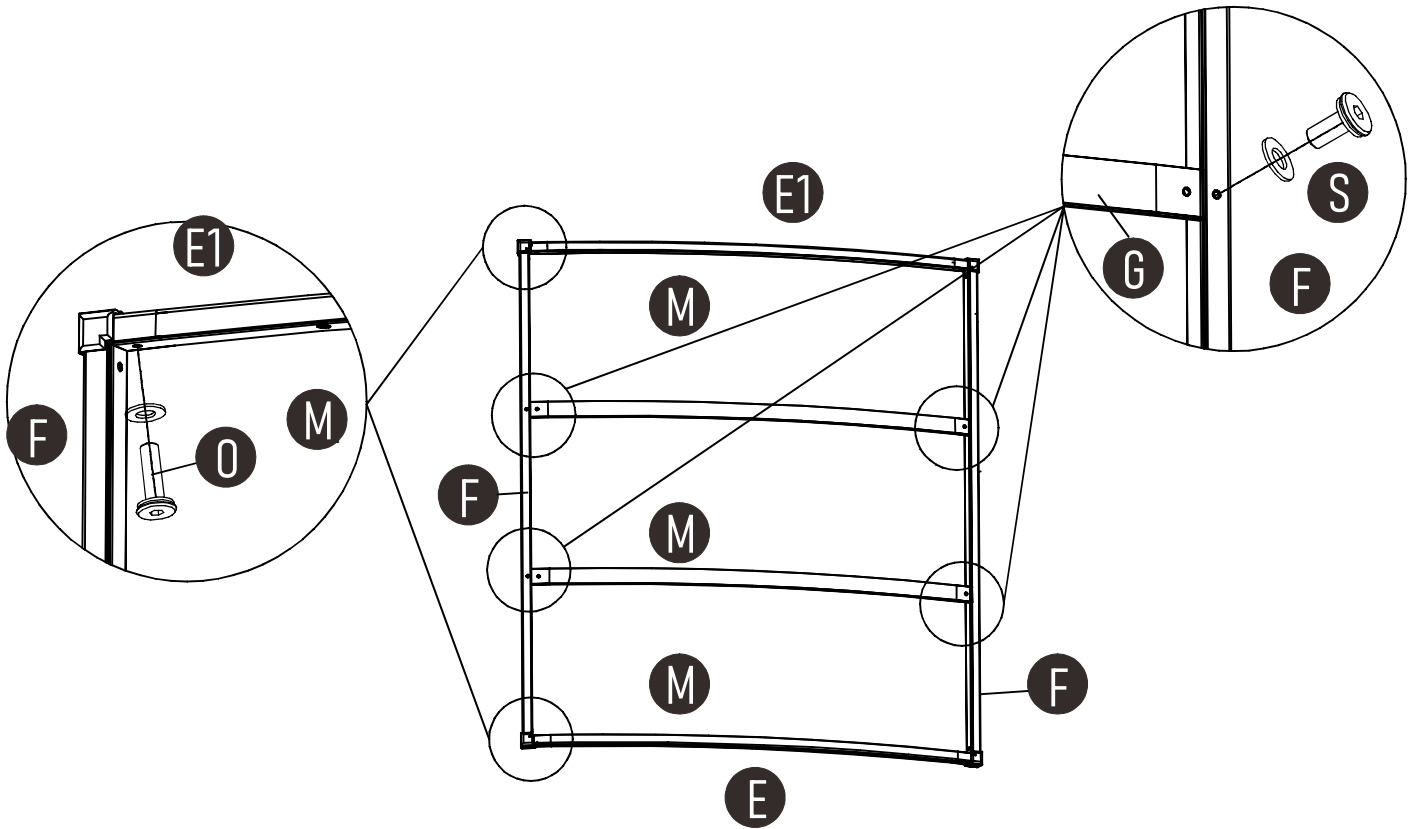
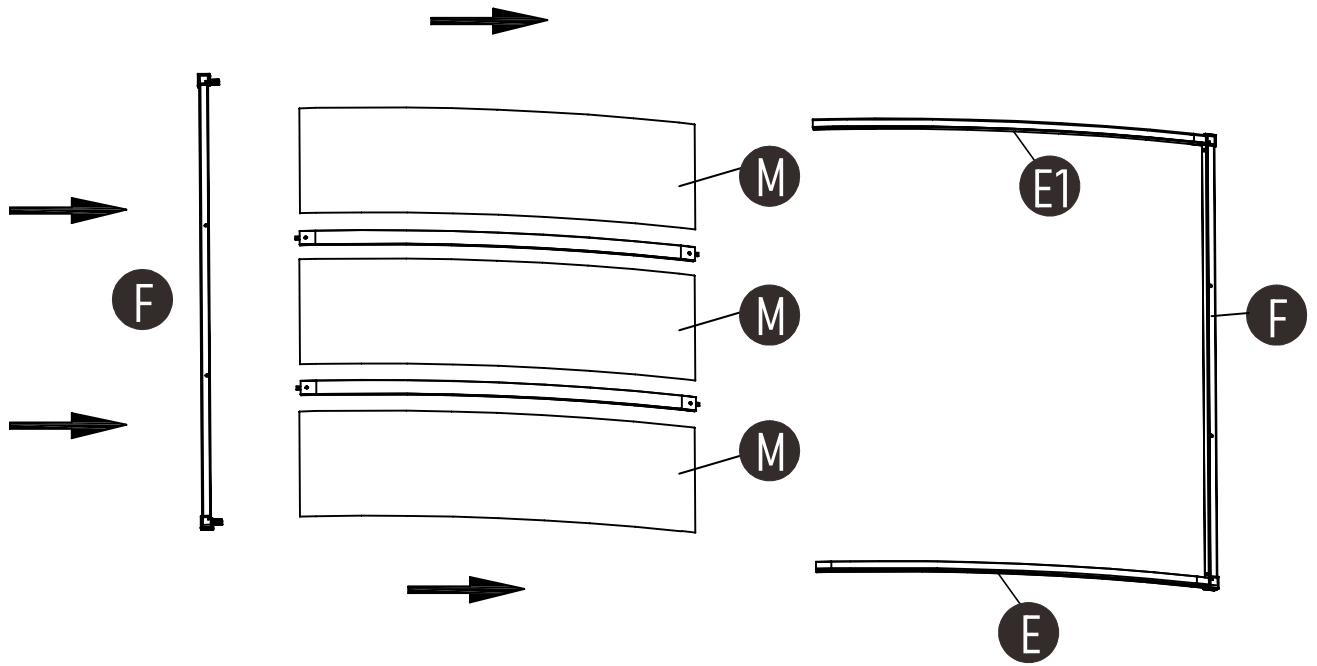

Mx3PCS

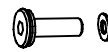

M6x15

Ox2PCS



M5x10

Sx4PCS

9

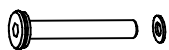
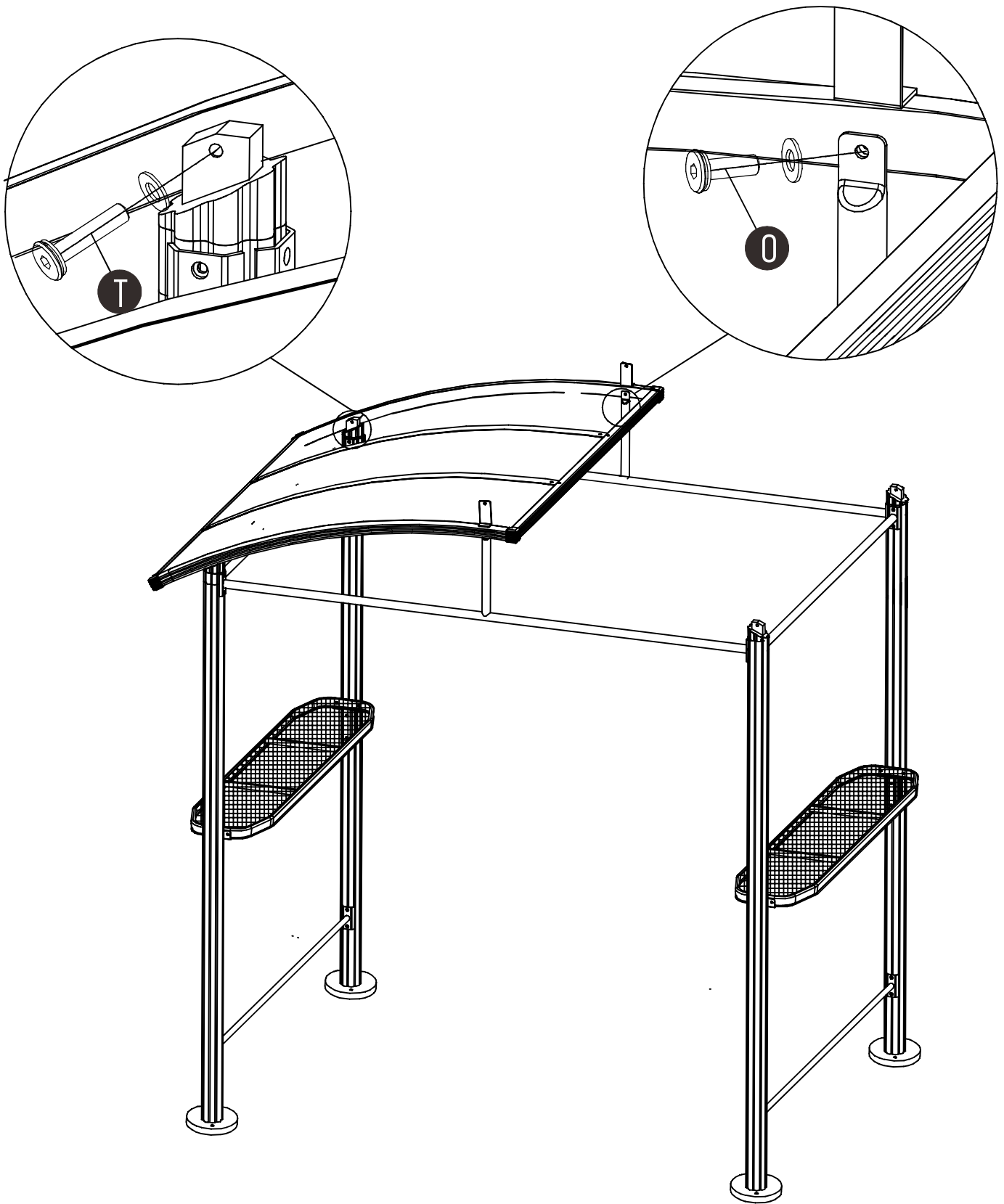

M6x35 Tx2PCS



M6x15 Ox2PCS

10

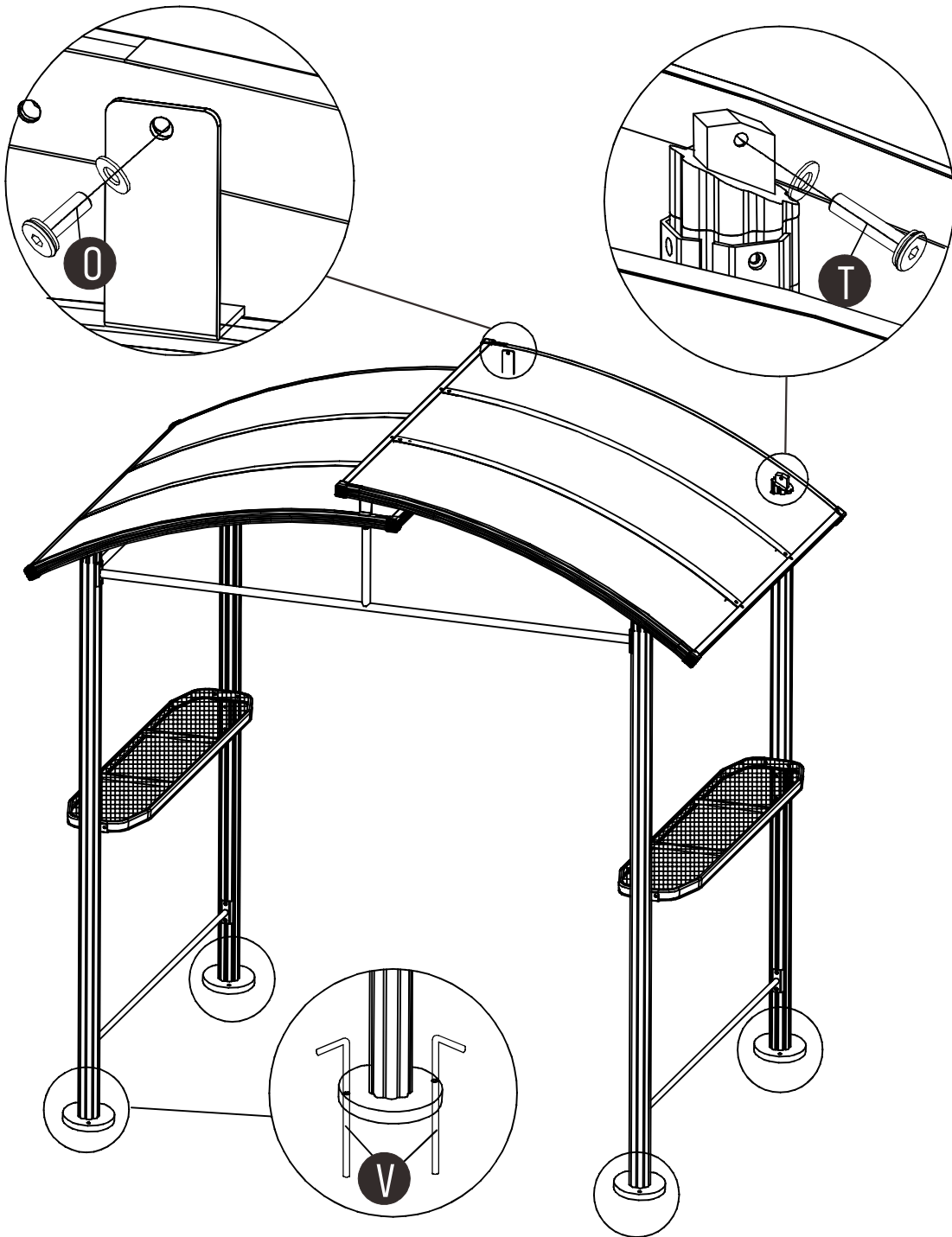

 M6x35 Tx2PCS

 M6x15 Ox2PCS

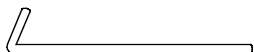
 Vx8PCS

Please don't hesitate to contact us for any further questions,  
 your satisfaction is guaranteed.  
[customerservice@aodor.com](mailto:customerservice@aodor.com)  
<https://www.aodor.com/>