





















A×4PCS  M6×35mm	B×4PCS  Ø15×12mm	C×4PCS  Ø8×30mm	D×2PCS  M6×30mm	E×2PCS  M6mm	F×2PCS  6mm
G×4PCS  M6×25mm	H×23PCS  M6×12mm	J×6PCS  Ø8×30mm	K×8PCS  Ø7×50mm	L×1PC  4mm	M×2PCS 
N×8PCS  Ø3.5×14mm					

1.

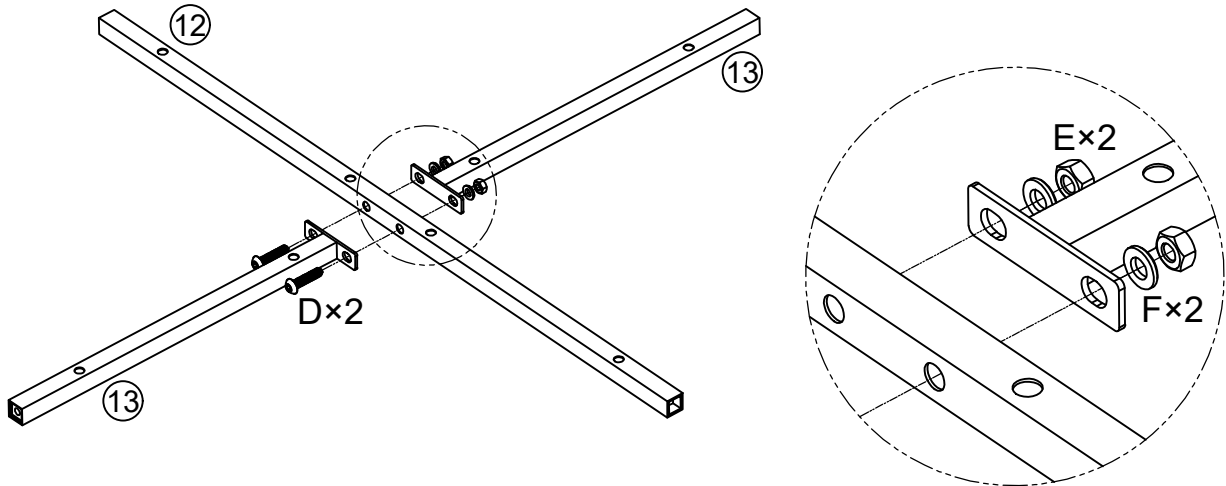
D×2PCS	E×2PCS	F×2PCS	L×1PC
			
M6×30mm	M6mm	6mm	M4mm



2.

G×4PCS	H×4PCS	J×6PCS	L×1PC
			
M6×25mm	M6×12mm		M4mm

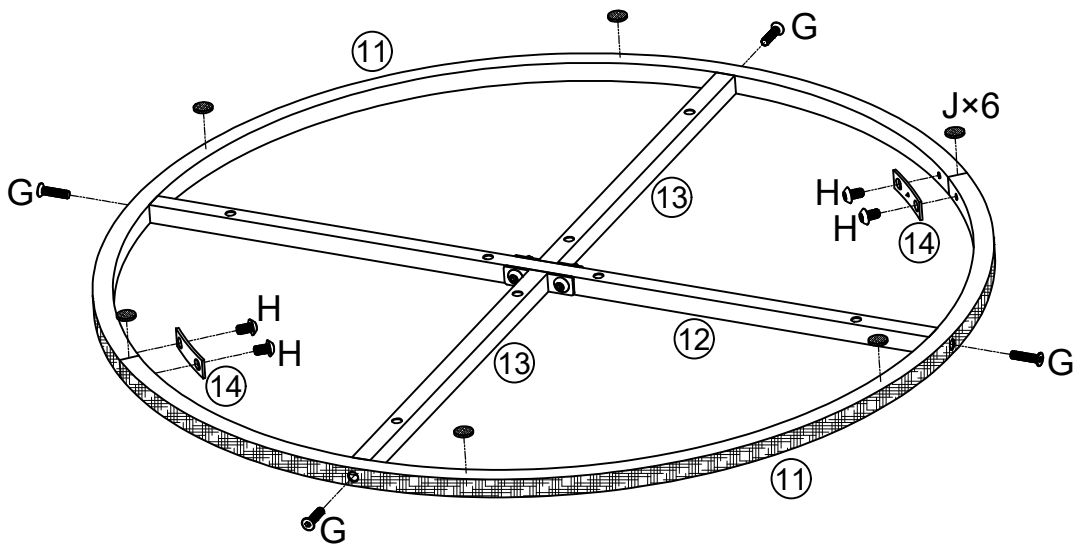

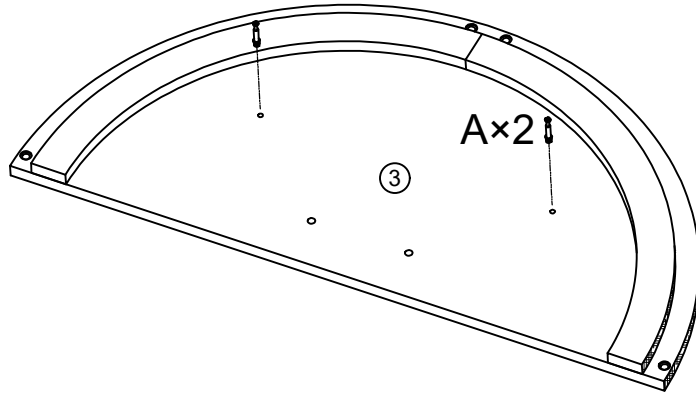

A×4PCS

M6×35mm

3.





×2

B×2PCS	C×2PCS
	
Ø15×12mm	Ø8×30mm

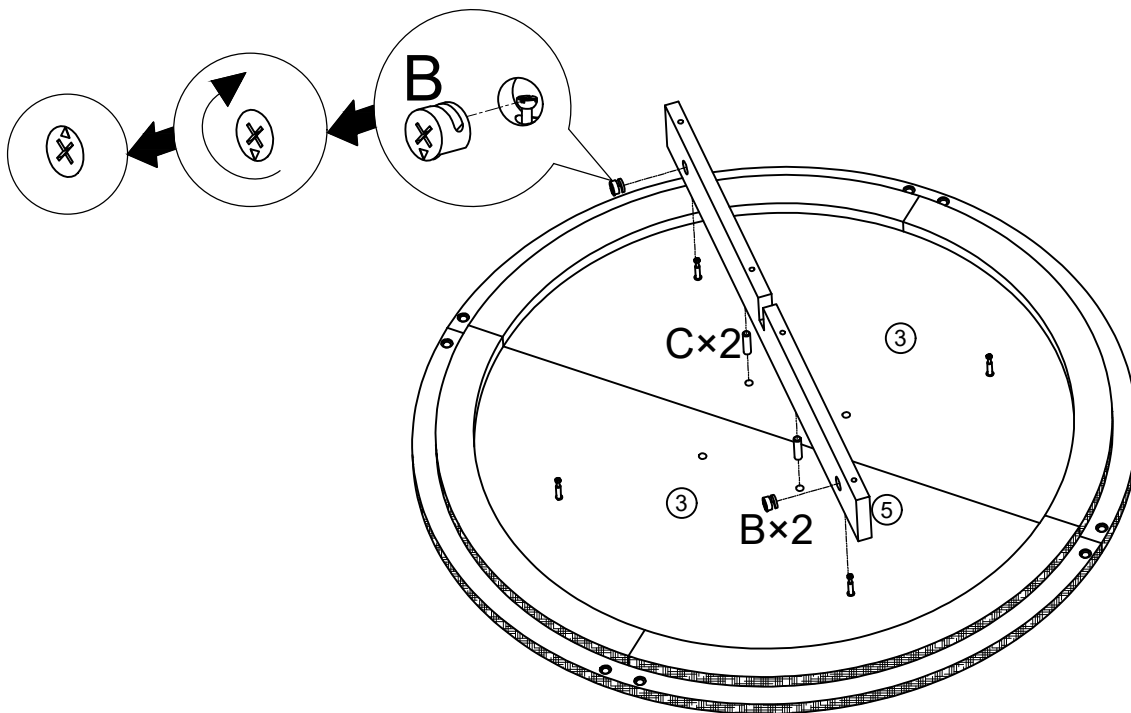
4.



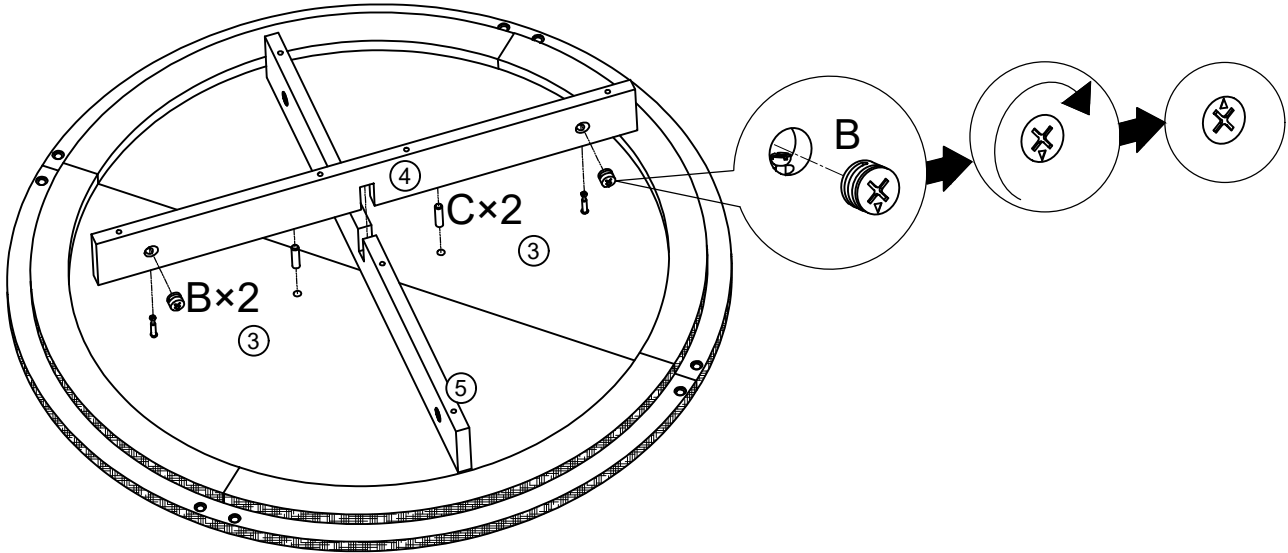

5.

B×2PCS	C×2PCS
	
Ø15×12mm	Ø8×30mm



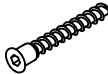

6.

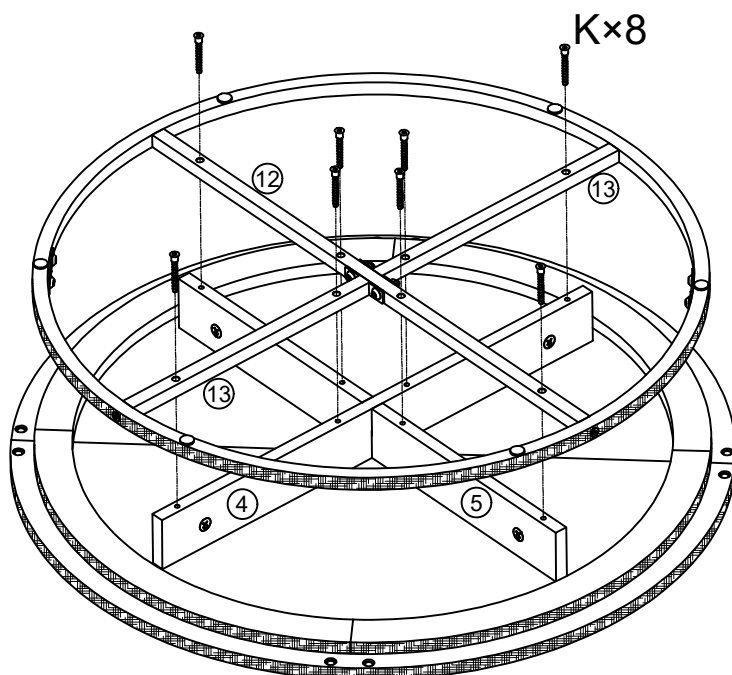
K×8PCS	L×1PC
	
Ø7×50mm	M4mm

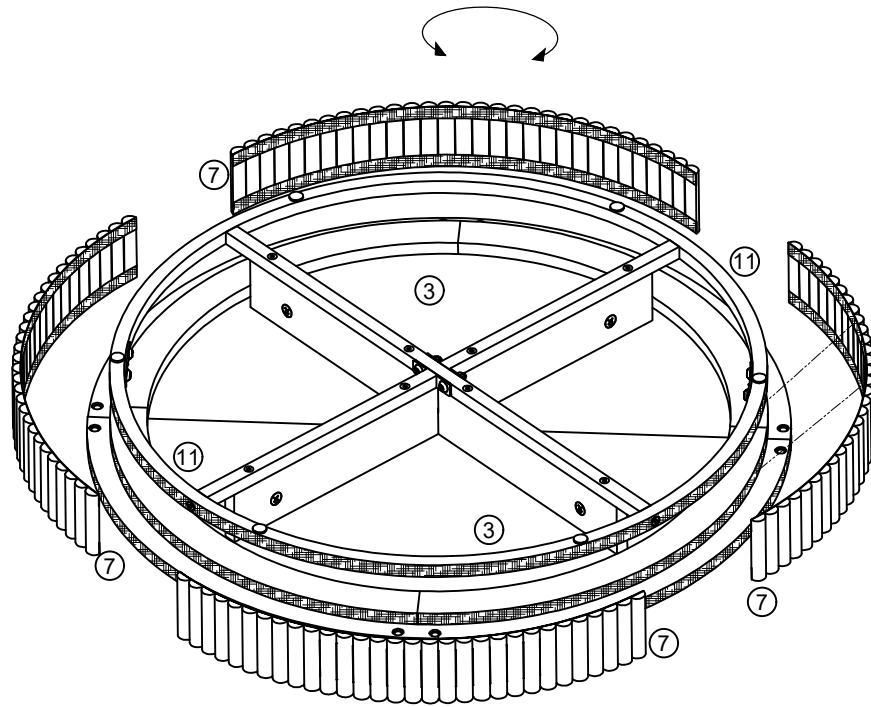

7.



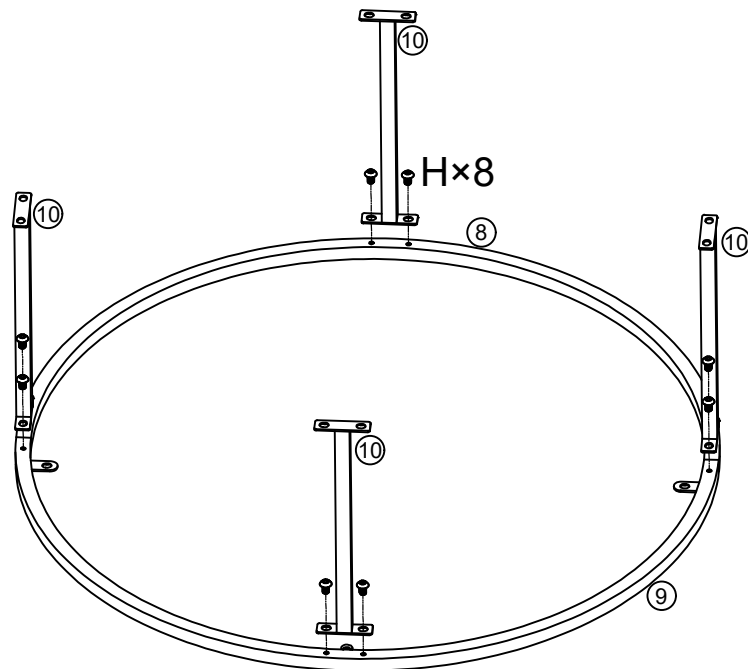

H×8PCS	L×1PC
	
M6×12mm	M4mm

8.



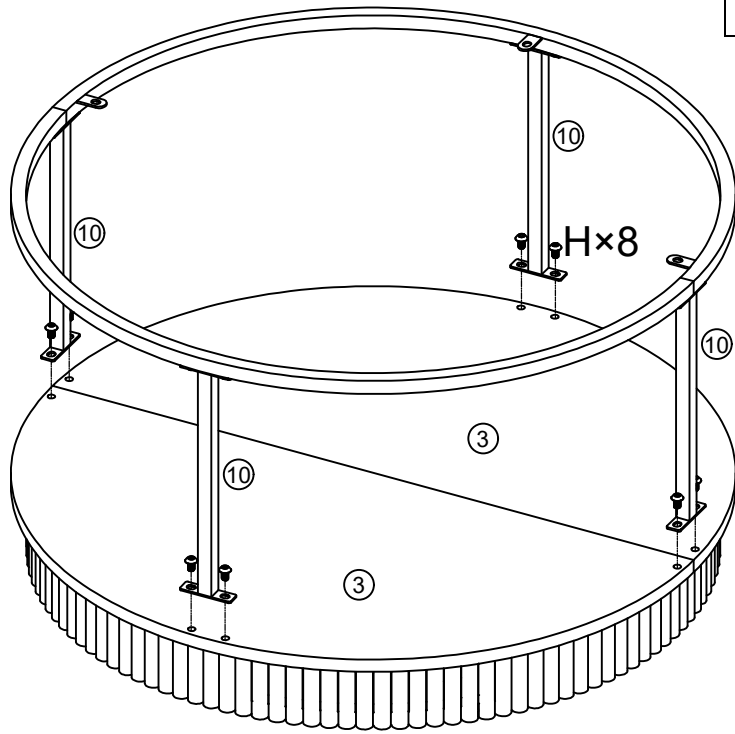

9.

H×8PCS	L×1PC
	
M6×12mm	M4mm





10.

M×2PCS	N×8PCS
	
	Ø3.5×14mm

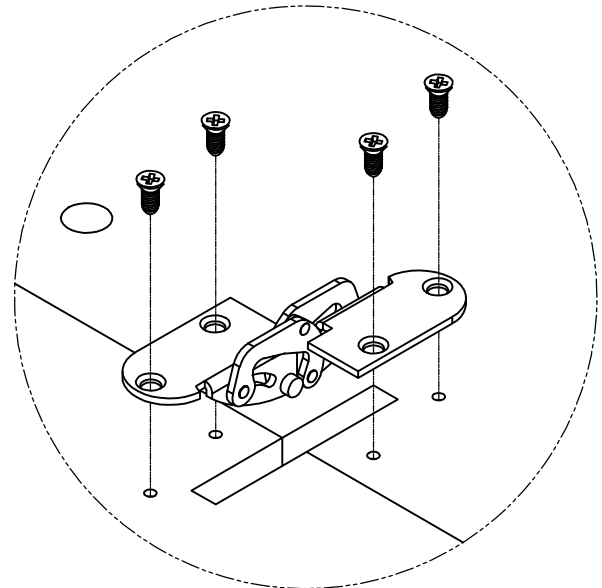
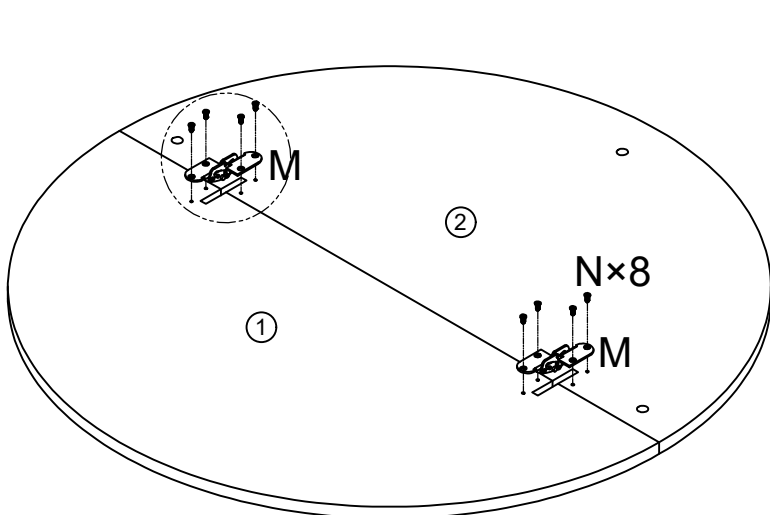
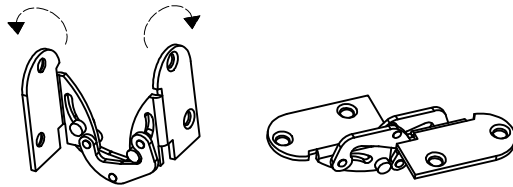
M×2



H×3PCS	L×1PC
	
M6×12mm	M4mm

11.

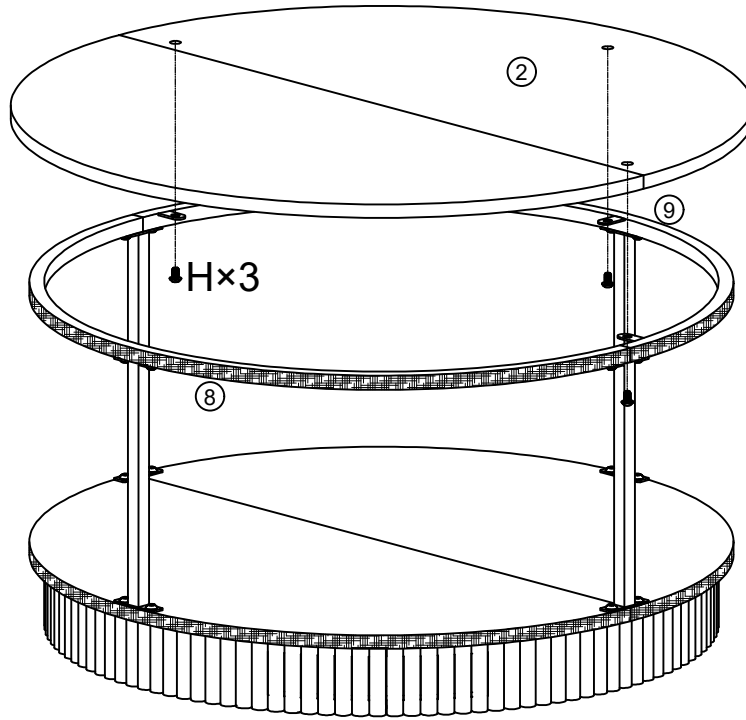

12.

