









ASSEMBLY INSTRUCTIONS & PARTS IDENTIFICATION DINING BENCH

Thank you for purchasing this quality product. Be sure to check all packing material carefully for small parts that may have come loose inside the carton during shipment.

Hardware kit			
No	Description		Q'Ty
A		Hexa Nut Ø5/16"	4 pcs
B		Lock Washer 5/16"	14 pcs
C		Flat Washer 5/16"	14 pcs
D		Long Bolt 1/4"x 3 11/32"	4 pcs
E		Medium Bolt 1/4"x 1 3/4"	2 pcs
F		Short Bolt 1/4"x 1 3/8"	4 pcs
G		Allen Key	1 pc
H		Key Wrench	1 pcs
I		Screw Ø4 x 38mm	10 pcs

Key Parts			
No	Code	Description	Q'Ty
1	A	Bench Back	1 pc
2	B	Complete Seat	1 pc
3	C	Right Front Leg	1 pc
4	D	Left Front Leg	1 pc
5	E	Middle Front Leg	1 pc
6	F	Right Stretcher	1 pc
7	G	Left Stretcher	1 pc
8	H	Center Stretcher	1 pc
9	I	Front Stretcher	2 pcs
10	J	Floor glide	6 pcs

STEP 1

- Carefully lay Chair Back flat on a smooth flat surface to prevent scratches.
- Affix Complete Seat to Chair Back by inserting a Flat Washer (C), Lock Washer (B) with Short Bolt (F) into each of the hole on the back rail of the seat, and Long Bolt (D) with washes into each of 2 holes in the Complete Seat corners. (See Detail A & B).
- Tighten screws with provided Allen Key (G) by turning clockwise until secure.

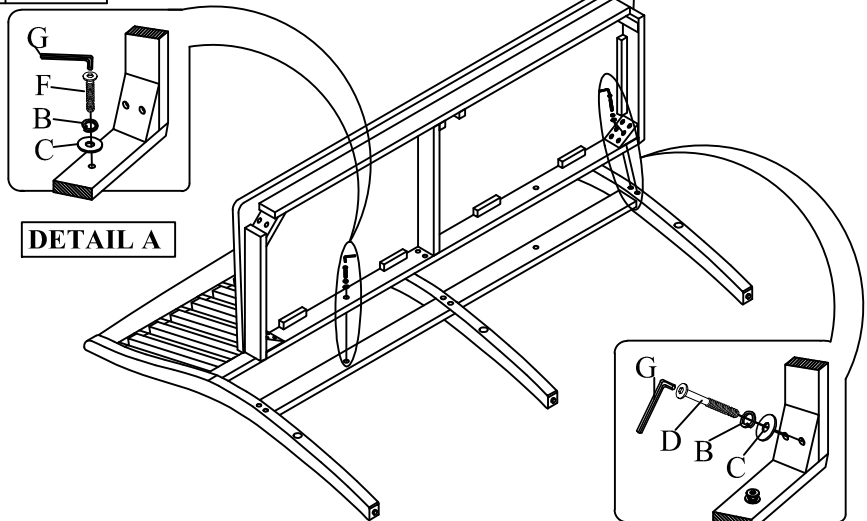

STEP 2

- Carefully turn chair upside down and attach Corner Front Legs to the front corner of the Complete Seat. (Keeping in mind of the right and left leg) with a Flat Washer (C), Lock Washer (B) and Nut (A). (See detail C). Keep Bolt loose at this point. Insert right stretcher and left side stretcher between the Front and Back Legs.
- Position the Middle stretcher into the Back Middle Leg. Position the Middle Front Leg into place and two front stretcher between the corner Front Legs and the Middle Front Leg. Secure the Middle Leg with a Flat Washer (C), Lock Washer (B) and Medium Bolt (E) (See detail (D)). Keep bolts loose at this point.
- Fasten Stretchers to legs with Screws (I) using a Screwdriver (not provided).
- Tighten all bolts for the front legs .

