























# Assembly Instructions

Caution: You must read this before you proceed

## Case & Maintenance

 	Not for commercial use. For residential use only.
 	Furniture may scratch floors. We recommend using furniture pads to protect your floors.
 	Do not put hot items directly on furniture surface.
 	Do not clean furniture with harsh cleansers or polish.
 	Do not place furniture under direct sunlight.
 	Do not write on furniture near heating or cooling vents.
 	Do not write on furniture without a padded barrier to protect the surface.
 	Do not place furniture outside for indoor use only
 	Stains may be removed with mild soap solution and damp cloth.
 	Children should not climb or jump on the furniture.
 	Dust and pick-upspills using a clean, non-colored, lint-free cloth.

Please look in the box for hardware packs and legs.



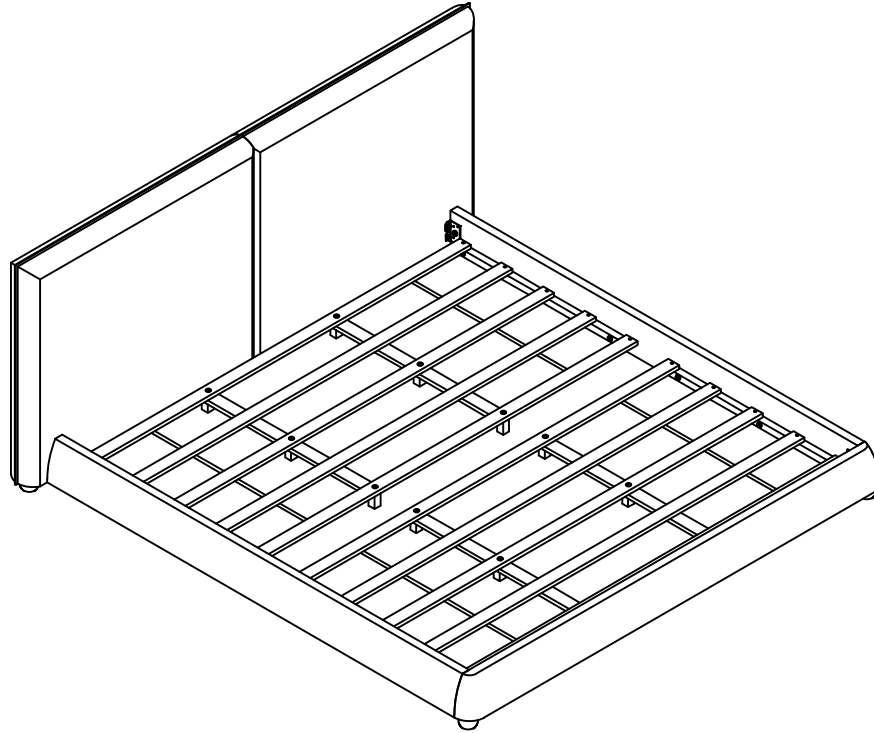

Sets often ship in multiple boxes and may arrive a day or two apart.

# King Bed

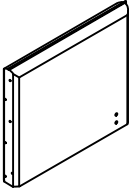
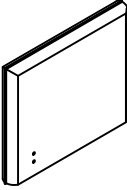
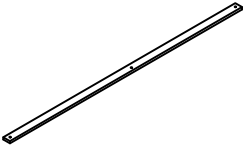

N757P420229

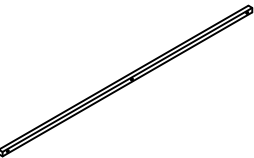
## Part List

①		Headboard(R)	1
②		Headboard(L)	1
⑥		Middle Support Bar	4
⑦		Center Support Leg	12
⑧		Support Rail	4
⑩		Bed Leg	6

Part List

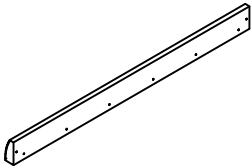
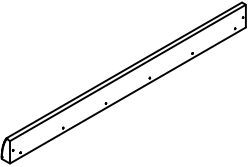
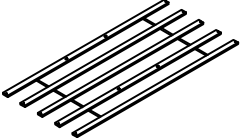
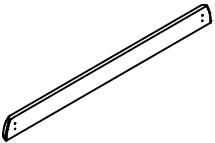

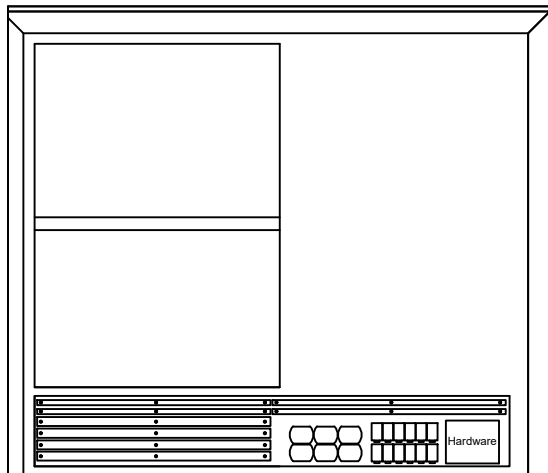





Label	Picture	Description	QTY
③		Side Rail(R)	1
④		Side Rail(L)	1
⑤		Slats	2
⑨		Footboard	1

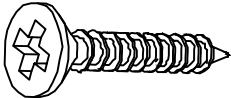
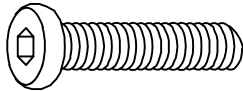
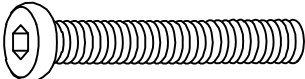

Noted: Middle Support Bar (6), Center Support Leg (7), Support Rail (8), Bed Leg(10) and Hardware package are packaged behind the Headboard(L) (2).

N757P420229



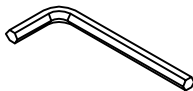



Hardware

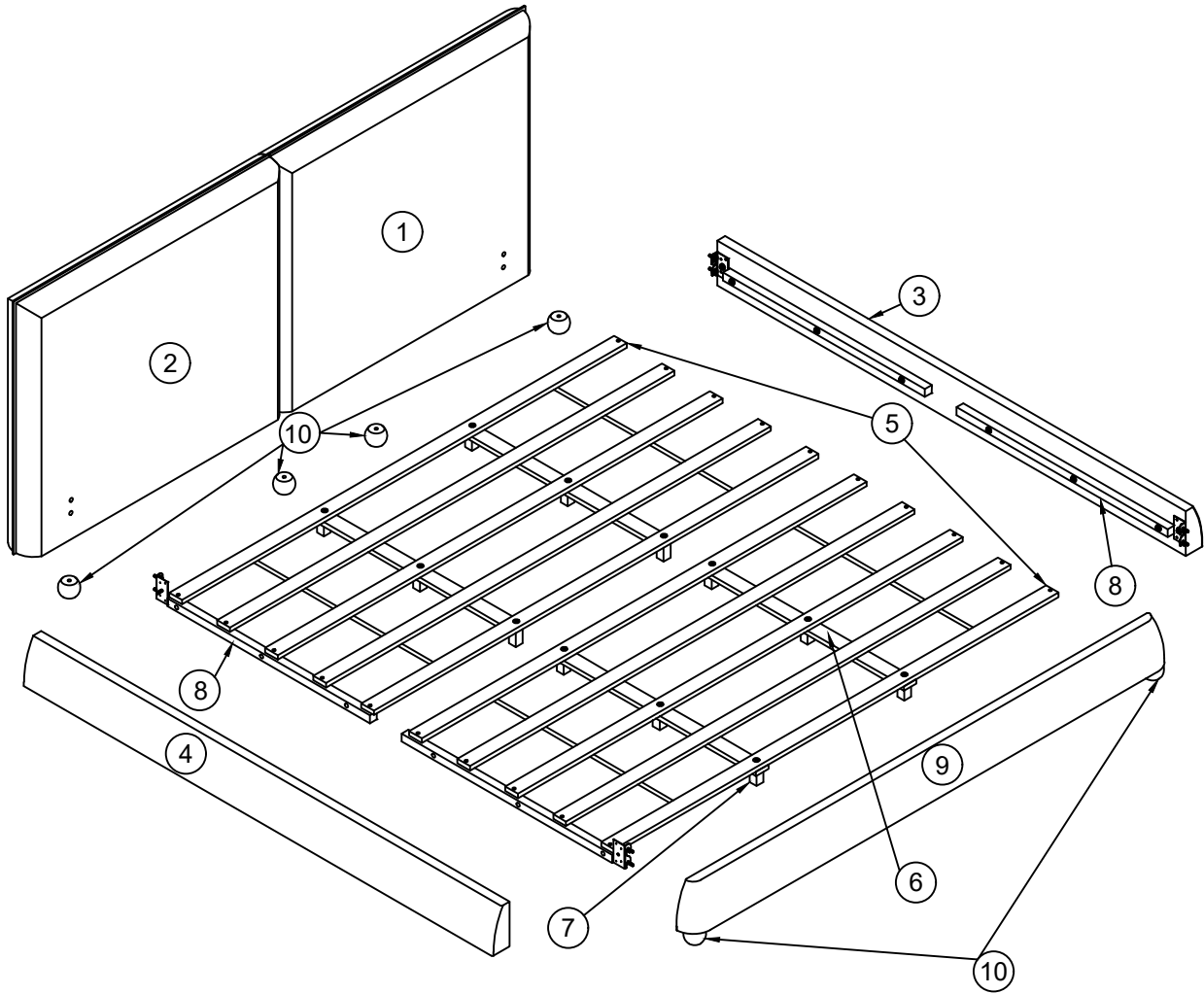

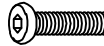

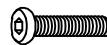
Label	Picture	Description	QTY
A		Screw(4x30mm)	36+1
B		Bolts(5/16"x30mm)	12+1
C		Bolts(5/16"x50mm)	24+1
D		Bolts(1/4"x50mm)	12+1
E		Lock washer(5/16")	36+1
F		Flat washer(5/16")	36+1
G		Lock washer(1/4")	12+1
H		Flat washer(1/4")	12+1
T		Metal pad(L)	2
K		Metal pad(R)	2
M		Allen Key (M4)	1+1

# Assembly Preparation

Before Beginning assembly:



A  x 36pcs+1	C  x 24pcs+1	E  x 36pcs+1	G  x 12pcs+1
B  x 12pcs+1	D  x 12pcs+1	F  x 36pcs+1	H  x 12pcs+1
			M  x 1pcs+1

-  Read the instructions cover to cover
-  Have 2 adults on hand for assembly
-  Do not assemble on flooring or carpet
-  Assemble on a clean, non-marring surface (packing foam)
-  Save all packaging until finished

# Assembly Steps

## OVERVIEW

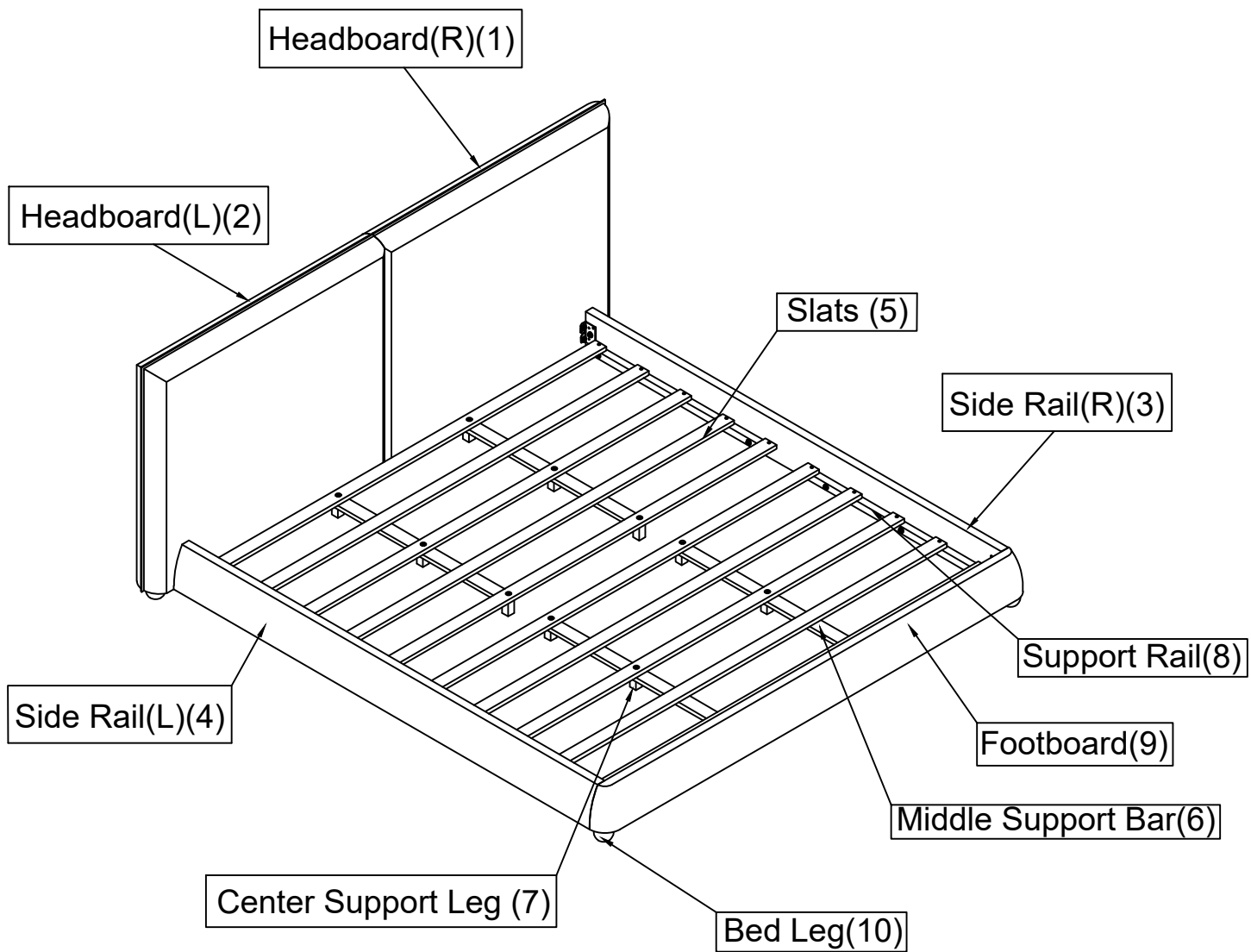

## FRONT FACING

This Bed have multiple parts and may require up to 30 minutes to assemble. To give you an overview of the Bed parts, the above picture is to help you put the various parts into perspective. Please read through the instructions below to familiarise yourself with the parts and steps before assembly.

Note: It is recommended that you have an adult partner to assist during the entire assembly process.

# Step 1

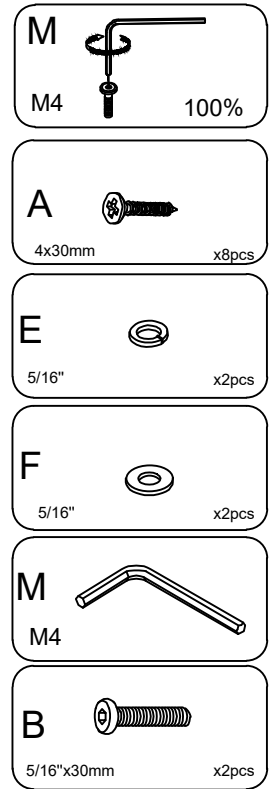
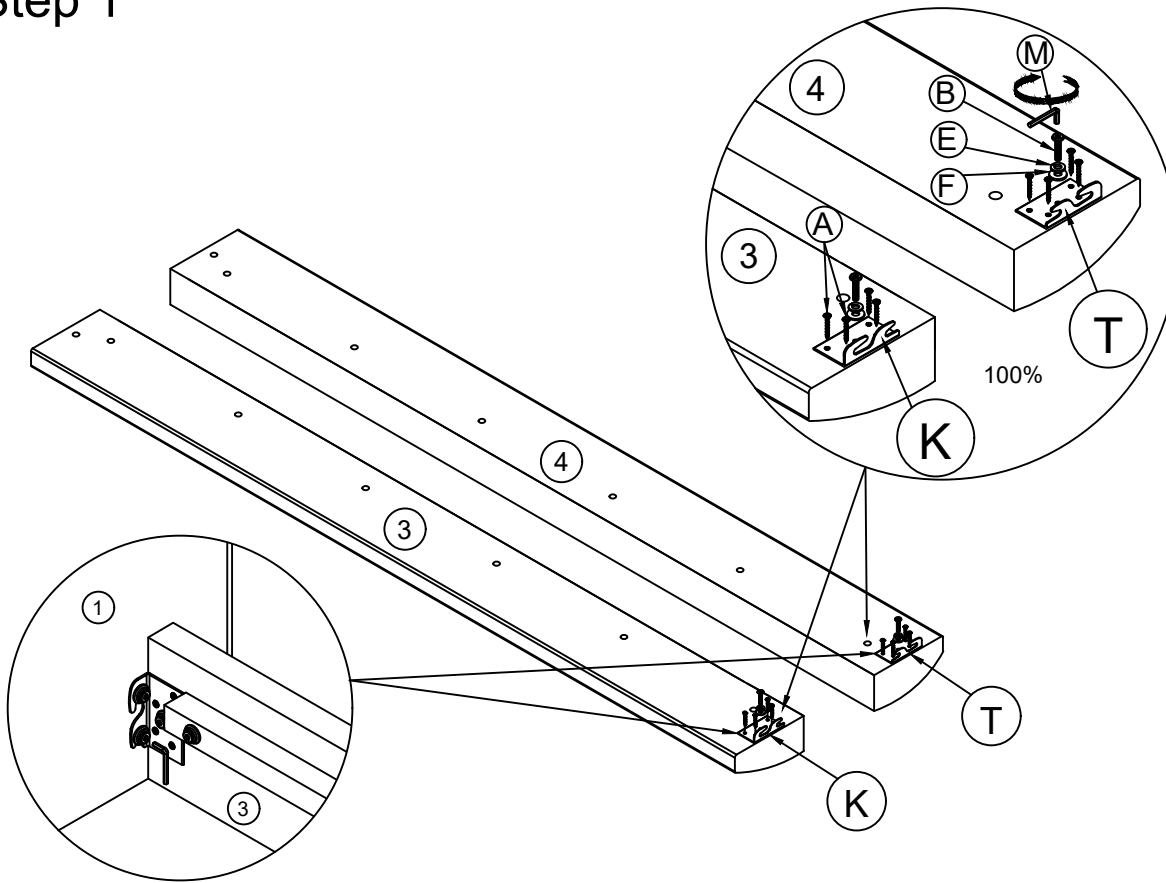

Attach the Metal pad (K) to the Side Rail (R) (3), attach the Metal pad (T) to the Side Rail (L) (4). By using the Bolts (B) and Flat Washer (F) with the Lock Washer (E) and Screw (A) to connect the Metal pad and the Side Rail  
 Note: The Metal pad hook is facing down and this place is connected to the Headboard(R) (1) and Headboard (L)(2).

# Step 2

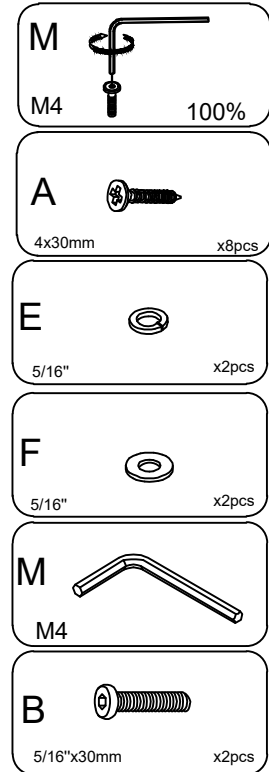
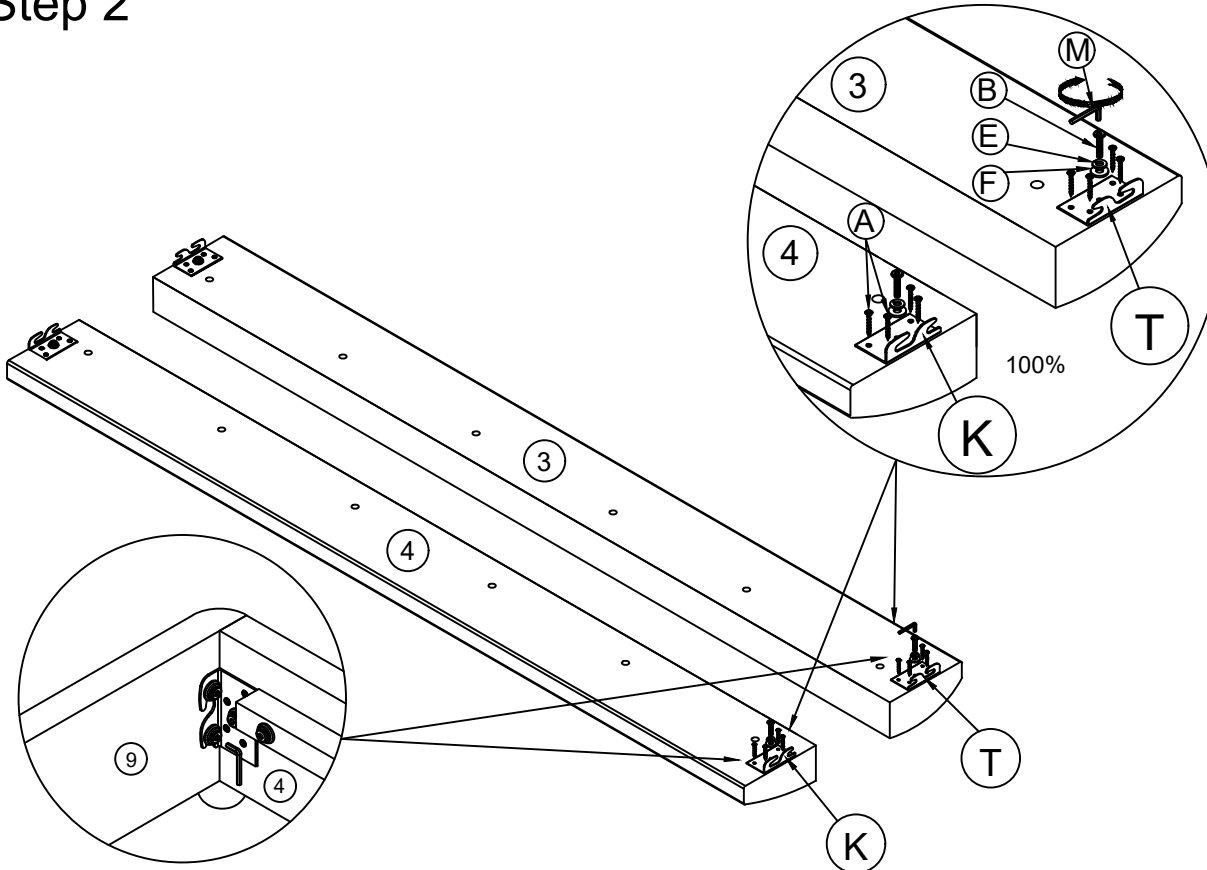

Use the Metal pad (T) to attach to the Side Rail (3), use the Metal pad (K) to attach the Side Rail (4).  
 By using the Screw (A) and the Bolts (B) with M4 Allen Wrench (M) to connect the Metal pad and the Side Rail  
 Note :The direction of the Metal Pad and this place is connected to the Footboard (9).

# Step 3

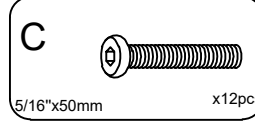
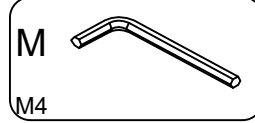
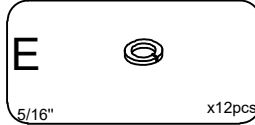
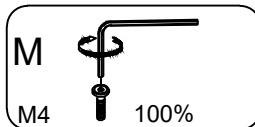
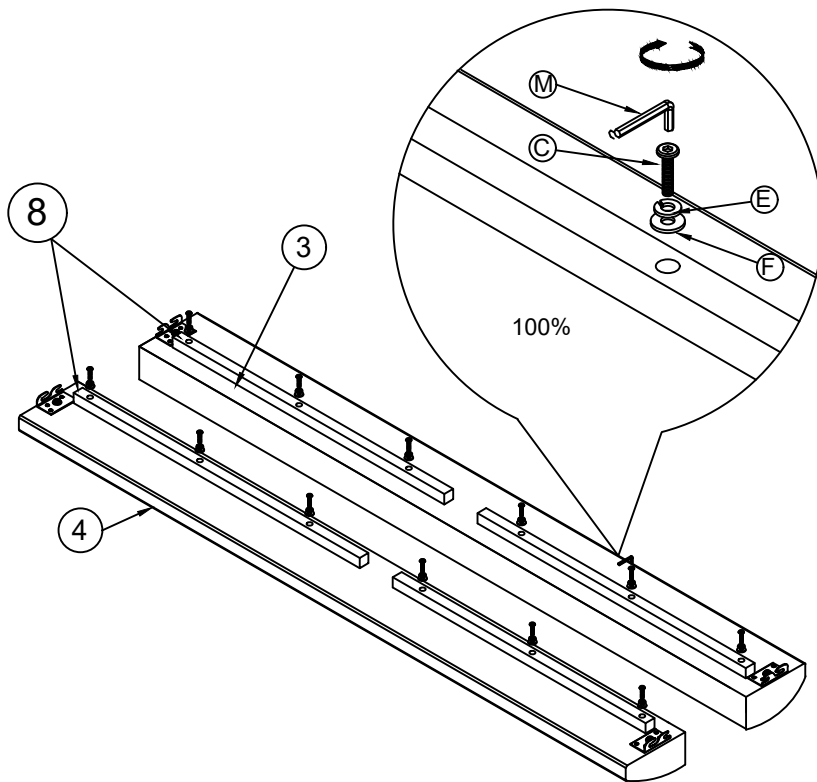

Attach the Support Rail (9) to the Side Rail (3) and the Side Rail (4). By using the Bolts (C), the Flat Washer (F) and the Lock Washer (E) with M4 Allen Key (M).

# Step 4

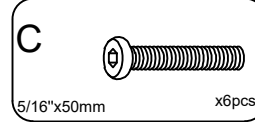
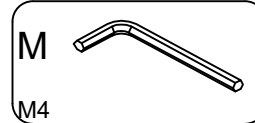
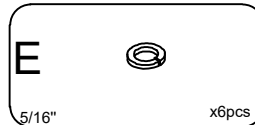
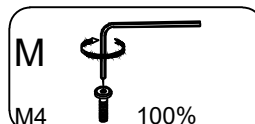
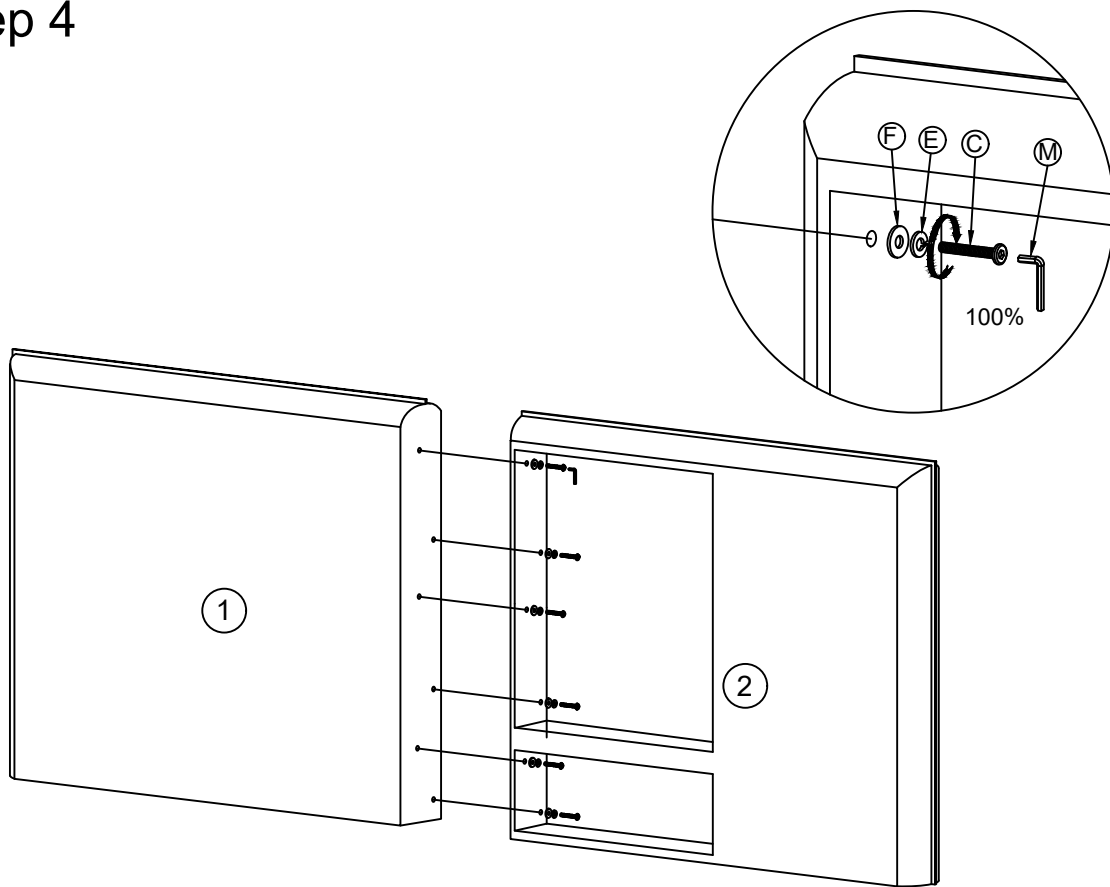

Use the Bolts (C), Lock washer (E) and Flat washer (F) to connect the Headboard (R) (1) and the Headboard (L) (2) then tighten with Allen Key (M).

# Step 5

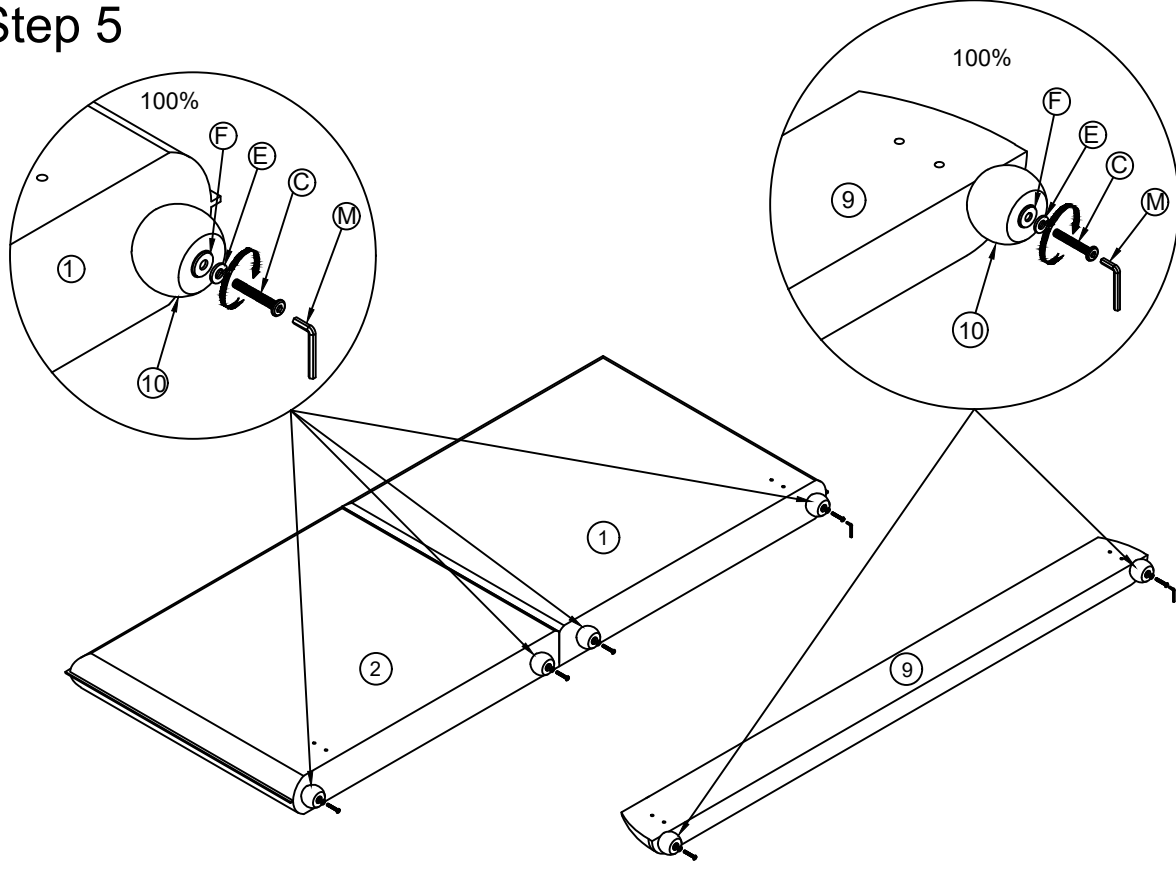

- M4 100%
- M4
- 5/16"x50mm x6pcs
- 5/16" x6pcs
- 5/16" x6pcs

Attach the Bed Legs(10) to the Headboard (R)(1), Headboard(L)(2) and the Footboard (9).  
By using the Bolts (C),the Flat Washer(F) and the Lock Washer(E) with M4 Allen Key (M)

# Step 6

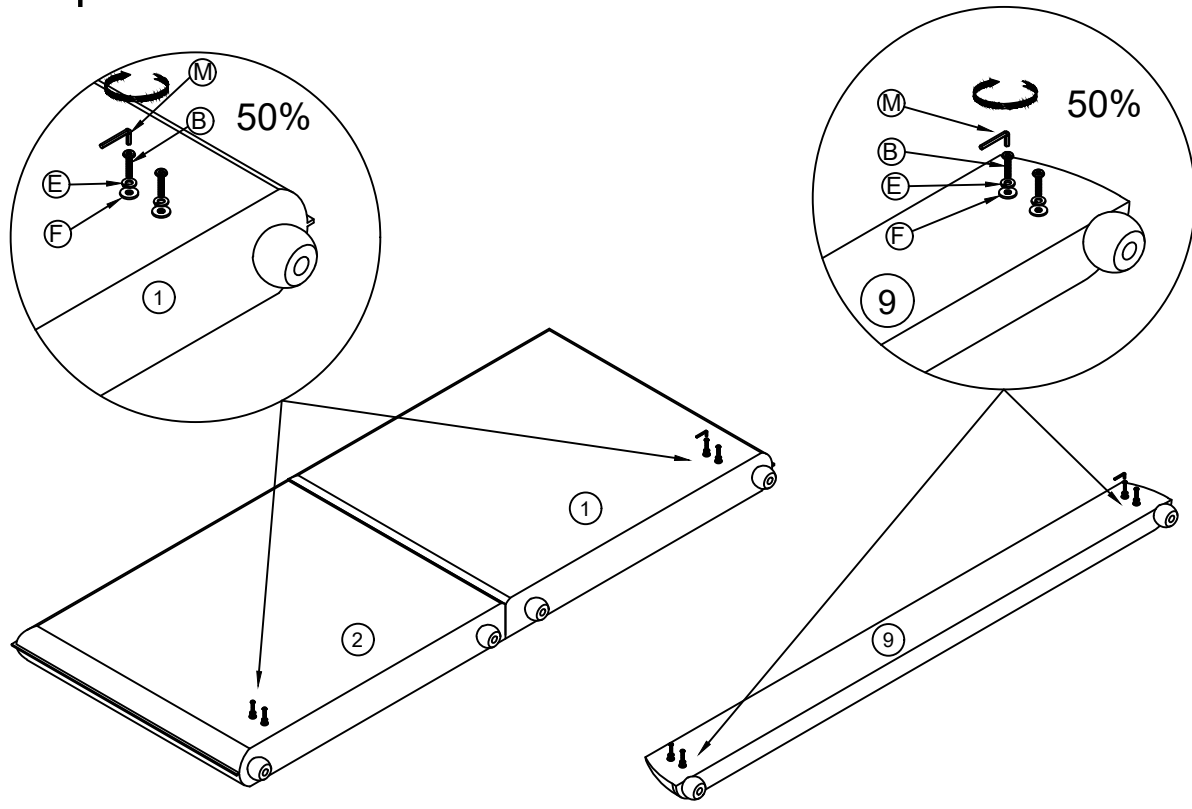

- M4 80%
- M4
- 5/16"x30mm x8pcs
- 5/16" x8pcs
- 5/16" x8pcs

Use Bolts (B) and Lock Washer (E) with Flat Washer (F). Then attach 1/2 Bolts (B) to the Headboard(R)(1), Headboard(L)(2) and Footboard (9).

# Step 7

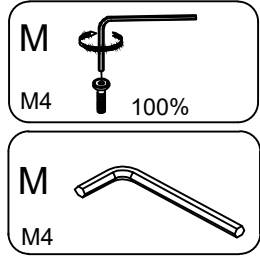
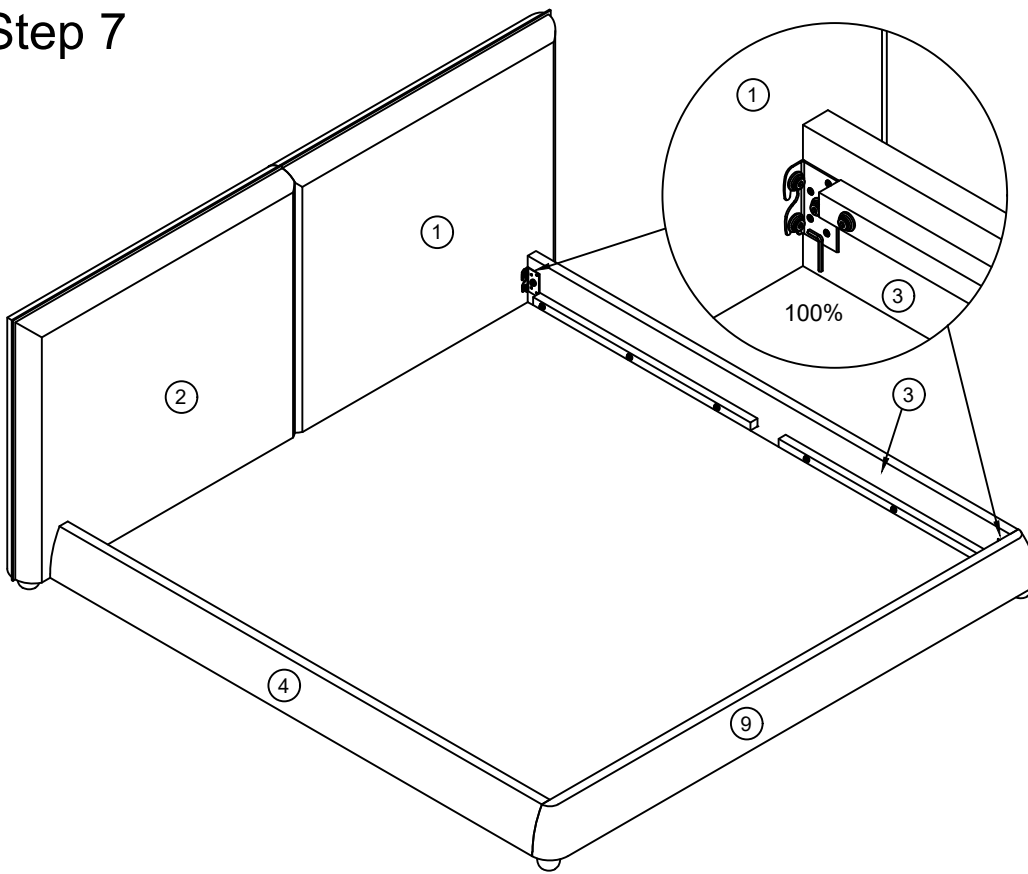

Attach the Side Rail (3) to the Headboard(R)(1) and the Side Rail (4) to the Headboard(L)(2), by using M4 Allen Key (M) to tighten the Bolts (B). Then attach the Footboard (9) to the Side Rail (3) and the Side Rail (4) by using M4 Allen Key (M) to tighten the Bolts (B). (Note: the direction of the Metal pad is down)

# Step 8

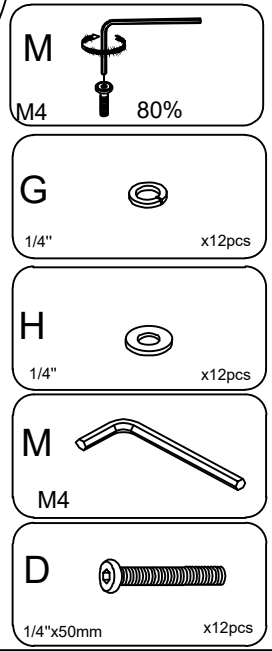
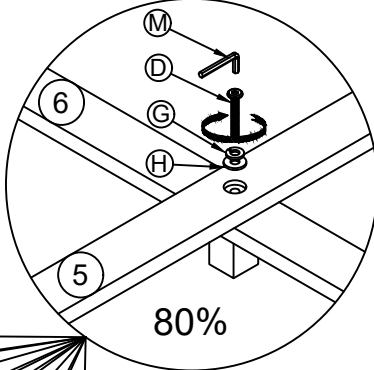
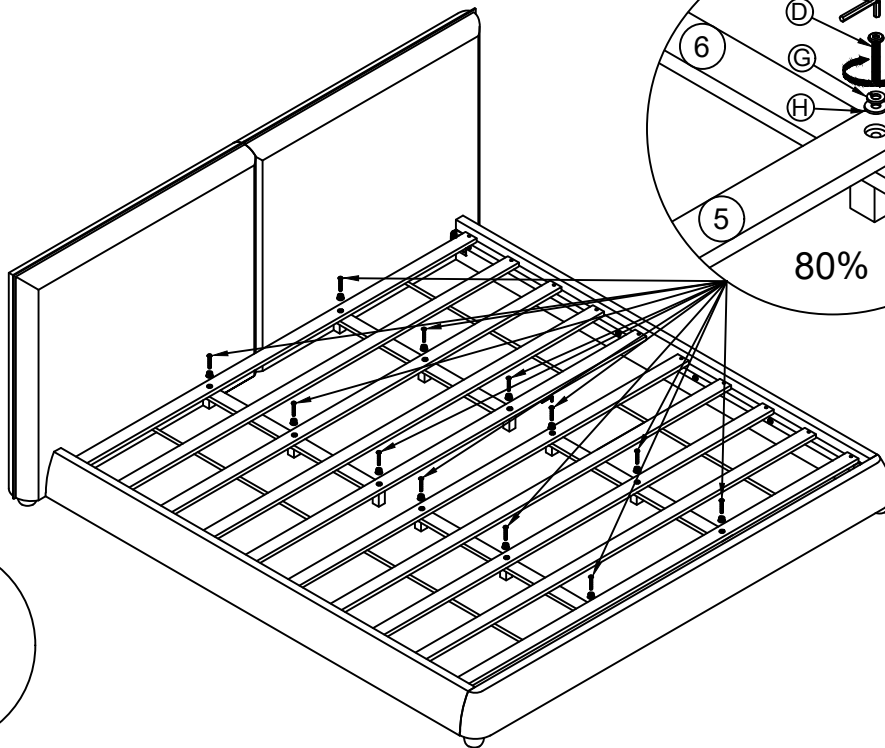

Align the assembly position on the Middle Support Bar (6) with the Center Support Leg (7) and the Slats (5) then attach them by using Bolts (D), Lock Washer (G) and Flat Washer (H) with M4 Allen Key (M).

## Step 9

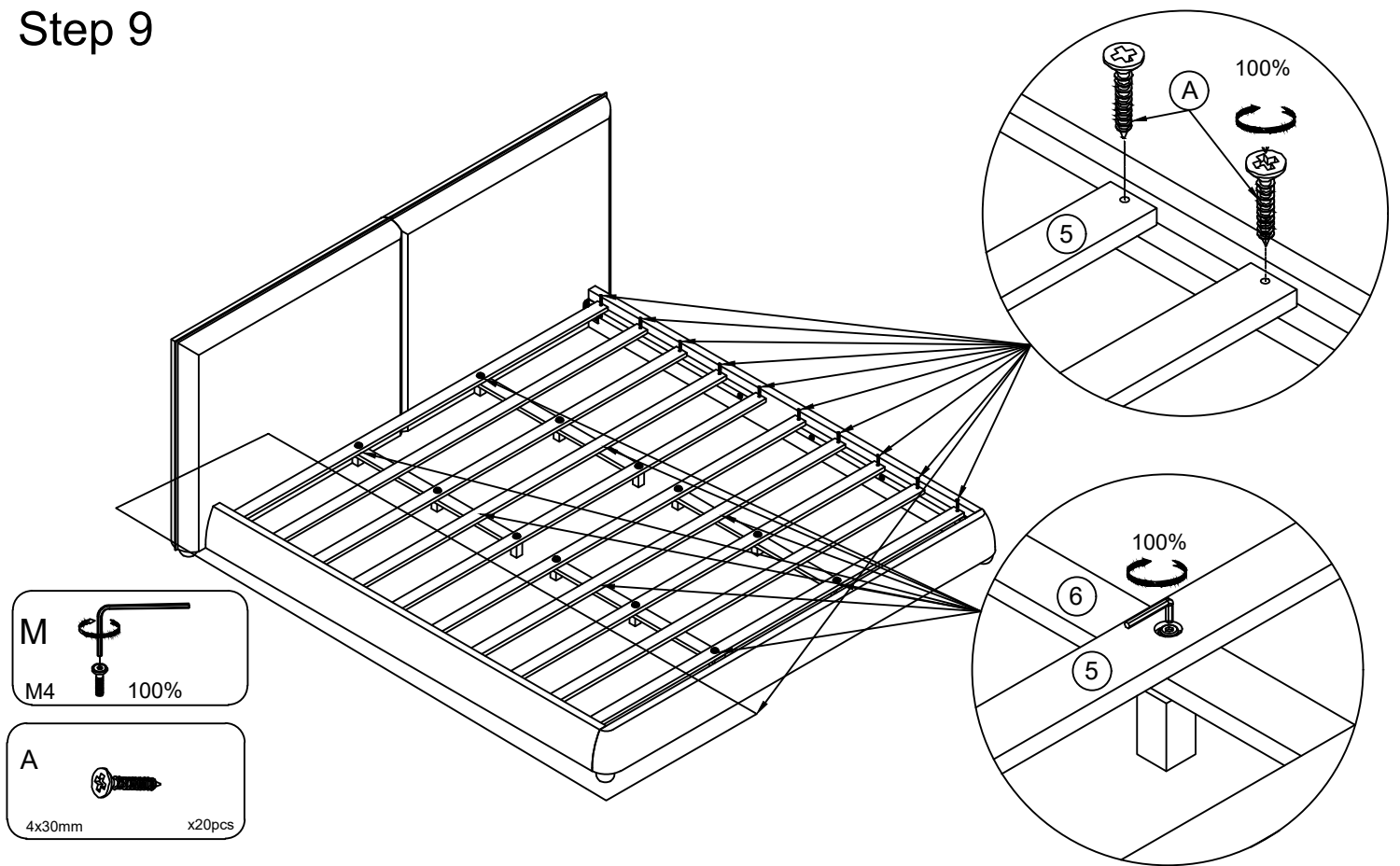

Assemble the Slats (5) to the bed Sides Rail (1) and (2). Use Screw (A).  
Finally, use the M4 Allen Key (M) to tighten the Bolts (D) 100%.

## Finish

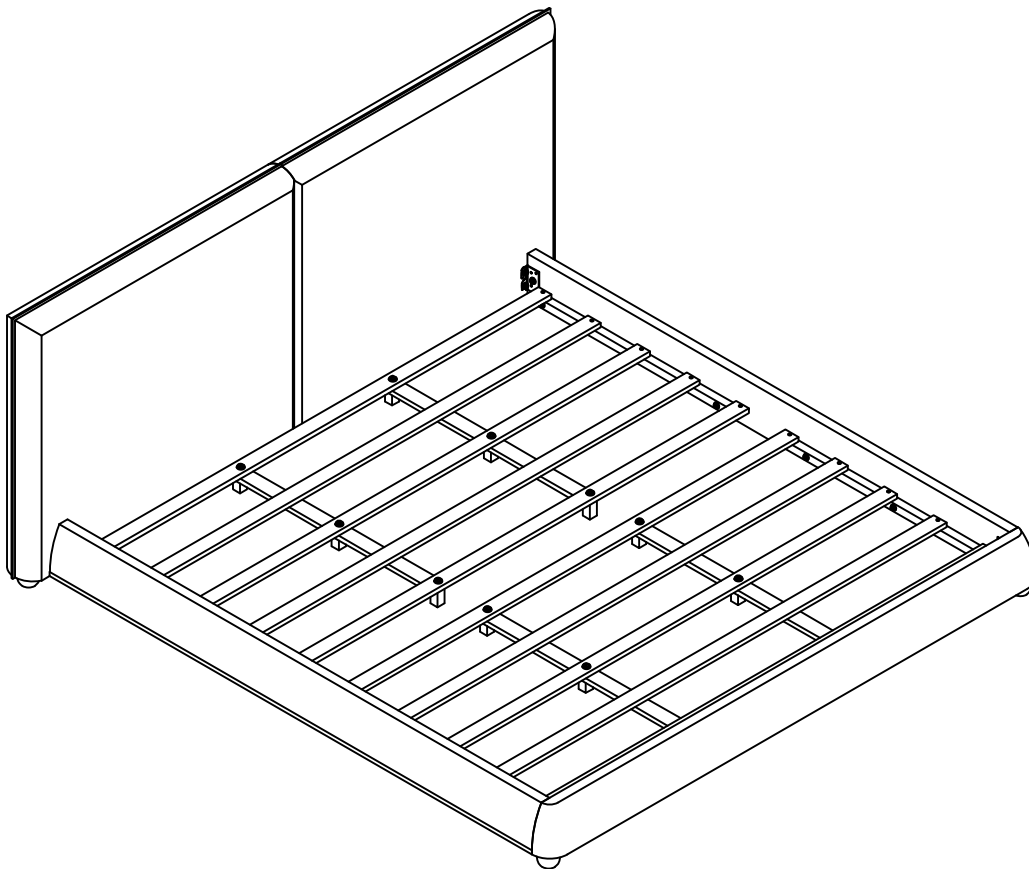

Thank you for your trust and preference in using our products.  
The product will bring you a peaceful sleep forever

## Finish

Place the Bed on a LEVEL SURFACE.

Inspect it and make sure all parts are adequately connected.

Don't push too hard,shake on the bed.

This would help to align all the parts at the joint areas.

CAUTION 1: When tightening these screws, tighten sequentially.

DO NOT tighten any screws fully and the towards the next one.

This would cause the frame to warp.

If there is still wobbles, loosen the screws and execute this same process.DO NOT tighten any screws fully and then towards the next one.

WARNING!! IF BED IS NOT STABLE, IT COULD LEAD TO DAMAGING THE PRODUCT.

Ensure all screws are fully locked into position.

After removing the pillow from the vacuum-sealed bag, it will take about 10 minutes to return to its normal shape.

The bed is ready to be used.

Caution 2: This bed can only be used on a flat,level surface.