

# 7 Pcs Sofa Set

## Instructions

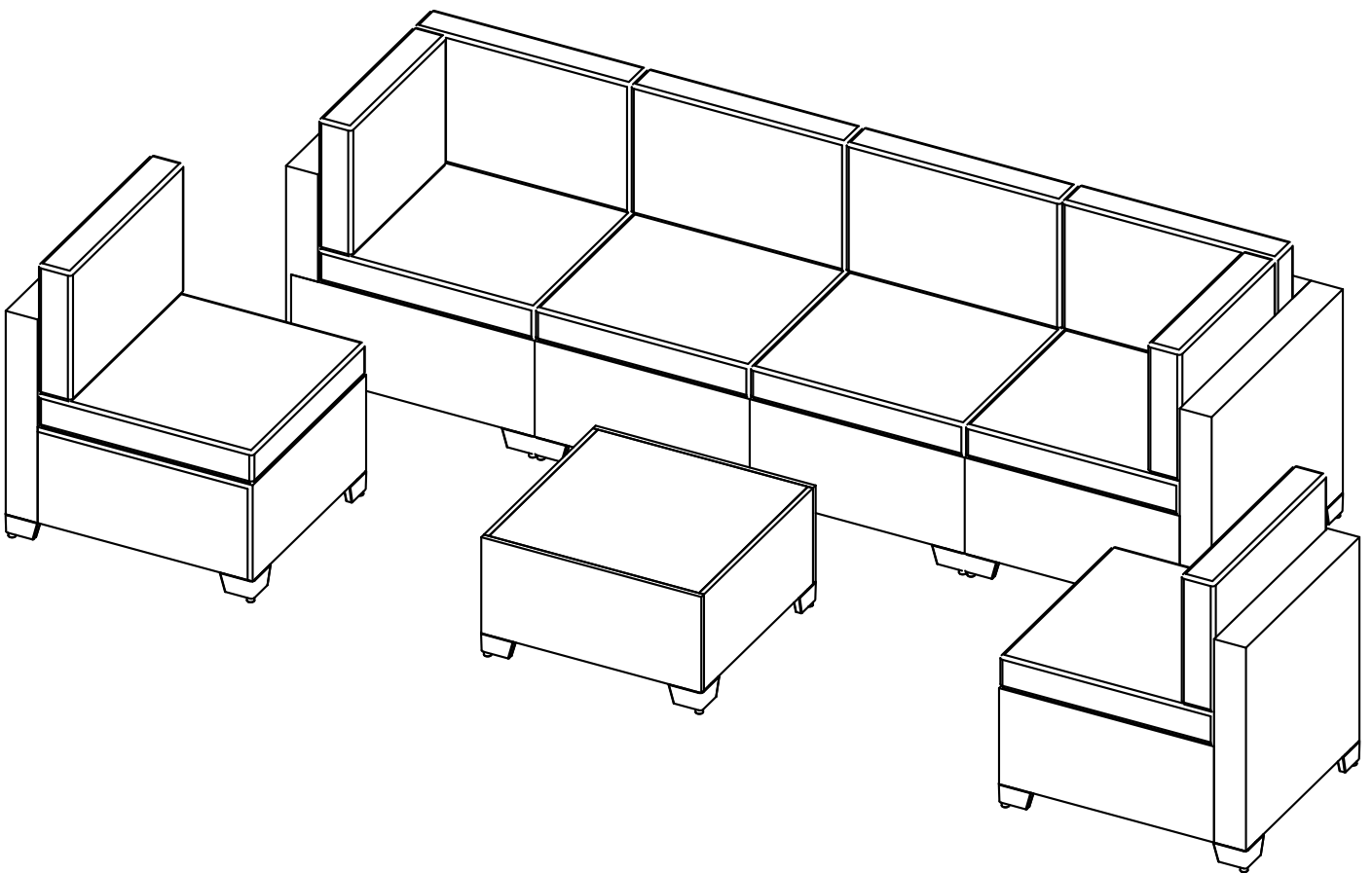

# IMPORTANT

This 7 pcs sofa's corner sofas are completely identical. Just rotate it 90 degrees to fit the combination.

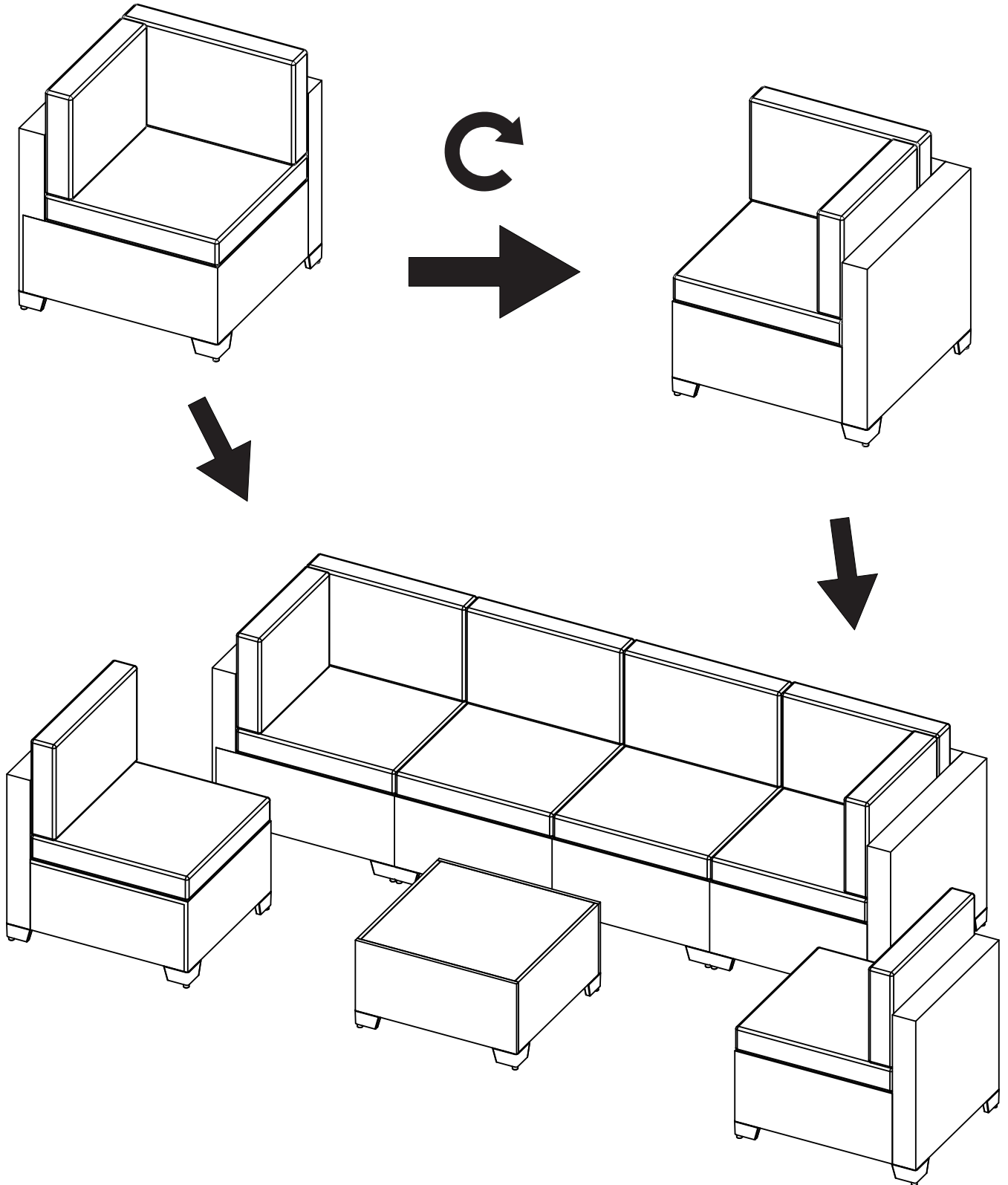

# Care & Instructions

Thank you for ordering the 7 pcs sofa set, here are some tips which may help you:

1. This 7 pcs sofa set comes in 3 boxes. If you only receive 1 box or 2 boxes, please do not worry. The others will arrive very soon.

2. Carton A contains 2 middle sofas plus 1 coffee table; Carton B contains 2 middle sofas; Carton C contains 2 corner sofas (The corner sofas are completely identical).

3. Amazon only allows us to upload 1 tracking number. If you want to know the others' tracking numbers, please contact us.

4. If any part is damaged or missing (please refer to packing list on page 6~11), please feel free to contact us. We will send you the replacement immediately.

5. In order to prolong the sofa set's service life, we suggest that you put all the cushions indoor on a rainy day.

6. We hope you can enjoy our product, if you have any other problem, please feel free to contact us.

## How To Cover Holes & Repair Broken Wicker



Step 1



Step 2



Step 3



Step 4

You can use two pieces PE wicker to cover the hole, and repeat the steps to cover all the holes. These PE wicker can also be used to repair the scratch or broken wicker.

# Catalog

Important.....	02
Care & Instructions.....	03
How to Cover Holes & Repair Broken Wicker.....	03
How to Assemble U-Shaped Connector.....	05
Parts List of Box A .....	06
Parts List of Box B.....	08
Parts List of Box C .....	10
How to Assemble Corner Sofa .....	12
How to Assemble Middle Sofa.. .....	14
How to Assemble Coffee Table.....	16
How to Accessory Replacement.....	19

# U-Shaped Connector

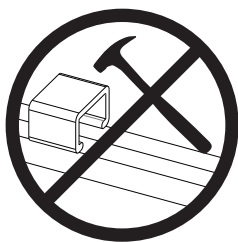
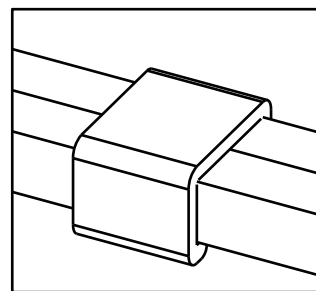
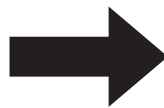
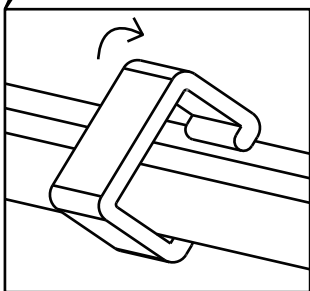
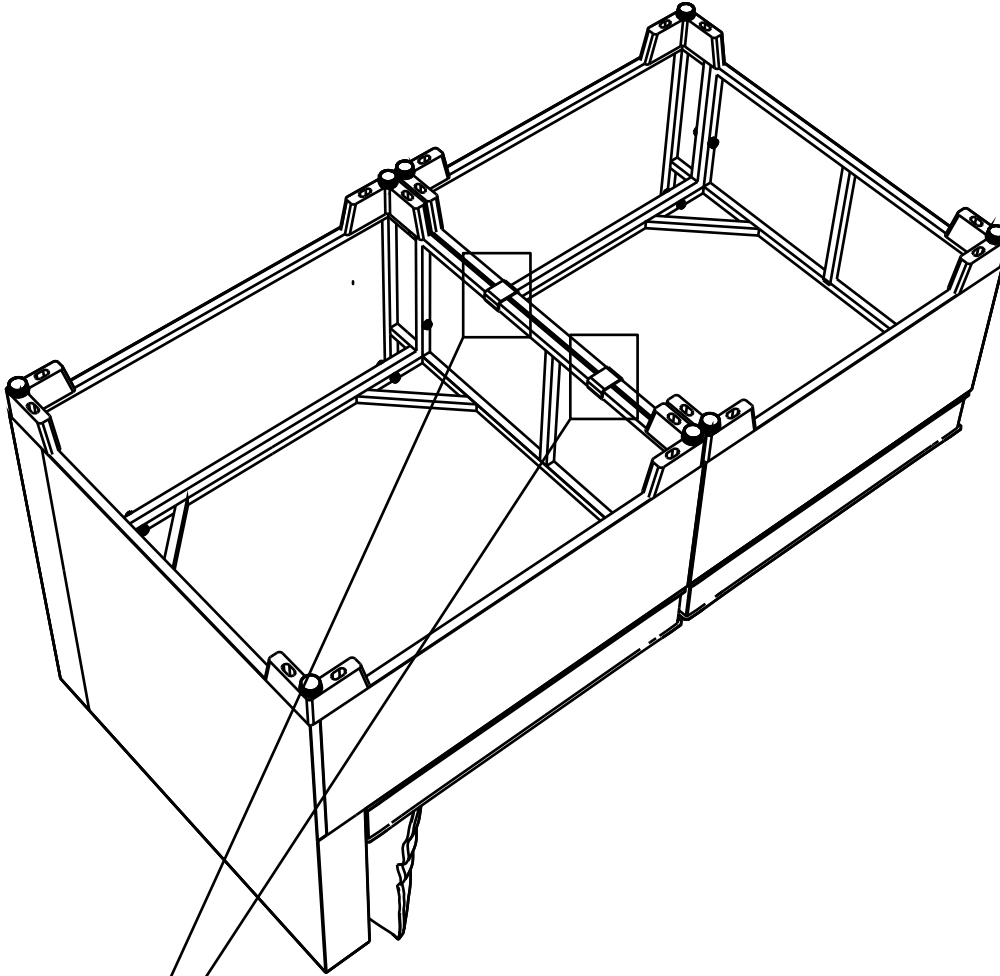





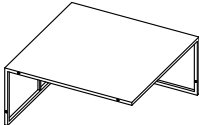
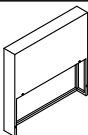
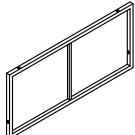
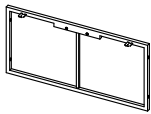
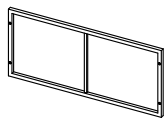
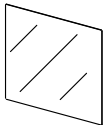
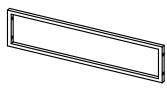
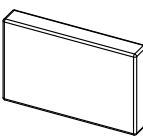
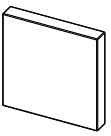
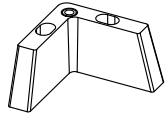
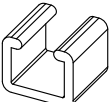













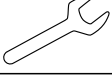

Notice:  
Do not use tools such as hammers;  
You can scald it with hot water to soften it.

# Packing List of Box A

Box	Img	Part Name	Label No.	Qty
Box A		Middle Sofa Seat Part	MST	2
		Middle Sofa Back Part	MBK	2
		Middle Sofa Side Part	MSD	2
		Coffee Table Short Side Part	CTS	2
		Coffee Table Long Side Part	CTL	2
		Coffee Table Glass Top	GLS	1
		Coffee Table Connector	CTC	1
		Long Back Cushion With Cover	LBCC	2
		Seat Cushion With Cover	SCC	2
		High L-Shaped Feet	O	12
		U-Shaped Connector	U	4
	—	Instructions	—	1
	—	Screw Set	SSA	1







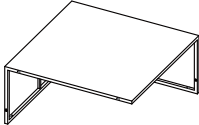
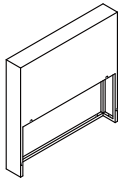
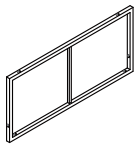
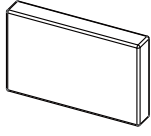
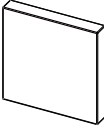
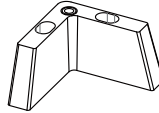
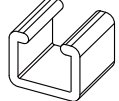





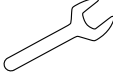

# Screw Set A

Product Name	Label No.	Img	Part Name	Qty
Middle Sofa's Screw × 2	S		Bolt M6×30	3
	Q		Bolt M6×45	4
	T		Bolt M6×60	8
	R		Washer Nut	12
	P		Adjustable Screws	4
	W		Spanner	1
	V		Wrench	1
Coffee Table's Screw × 1	S		Bolt M6×30	12
	Q		Bolt M6×45	8
	R		Washer Nut	8
	P		Adjustable Screws	4
	X		Glass Mat	5
	W		Spanner	1
	V		Wrench	1
Additional Screws-A	S		Bolt M6×30	2
	Q		Bolt M6×45	2
	T		Bolt M6×60	2
	R		Washer Nut	2
	P		Adjustable Screws	1
	Y		Restoration of rattan	1
	Z		velcro	1

# Packing List of Box B

Box	Img	Part Name	Label No.	Qty
Box B		Middle Sofa Seat Part	MST	2
		Middle Sofa Back Part	MBK	2
		Middle Sofa Side Part	MSD	2
		Long Back Cushion With Cover	LBCC	2
		Seat Cushion With Cover	SCC	2
		High L-Shaped Feet	O	8
		U-Shaped Connector	U	4
	—	Instructions	—	1
	—	Screw Set	SSB	1







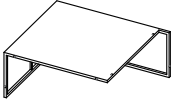
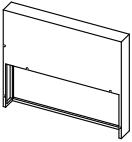
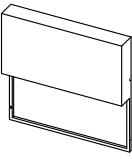
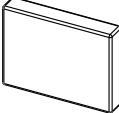
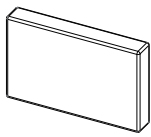
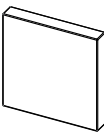
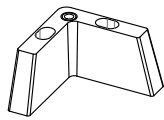
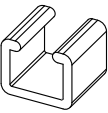





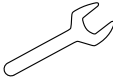

# Screw Set B

Product Name	Label No.	Img	Part Name	Qty
Middle Sofa's Screw × 2	S		Bolt M6×30	3
	Q		Bolt M6×45	4
	T		Bolt M6×60	8
	R		Washer Nut	12
	P		Adjustable Screws	4
	W		Spanner	1
	V		Wrench	1
Additional Screws-B	S		Bolt M6×30	2
	Q		Bolt M6×45	2
	T		Bolt M6×60	2
	R		Washer Nut	2
	P		Adjustable Screws	1
	Y		Restoration of rattan	1
	Z		velcro	1

# Packing List of Box C

Box	Img	Part Name	Label No.	Qty
Box C		Corner Sofa Seat Part	CST	2
		Corner Sofa Long Back Part	CLB	2
		Corner Sofa Short Back Part	CSB	2
		Short Back Cushion With Cover	SBCC	2
		Long Back Cushion With Cover	LBCC	2
		Seat Cushion With Cover	SCC	2
		High L-Shaped Feet	O	10
		U-Shaped Connector	U	4
	—	Instructions	—	1
	—	Screw Set	SSC	1

# Screw Set C

Product Name	Label No.	Img	Part Name	Qty
Corner Sofa's Screw × 2	S		Bolt M6×30	1
	Q		Bolt M6×45	7
	T		Bolt M6×60	8
	R		Washer Nut	15
	P		Adjustable Screws	4
	W		Spanner	1
	V		Wrench	1
Additional Screws-B	S		Bolt M6×30	2
	Q		Bolt M6×45	2
	T		Bolt M6×60	2
	R		Washer Nut	2
	P		Adjustable Screws	1
	Y		Restoration of rattan	1
	Z		velcro	1

# Corner Sofa



Do not use machine



Two Persons together



Need 25mins roughly

**Step 1: Assemble Long Back Part(CLB) And Seat Part(CST).**

**Tips: Do not tighten 100%.**

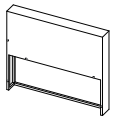
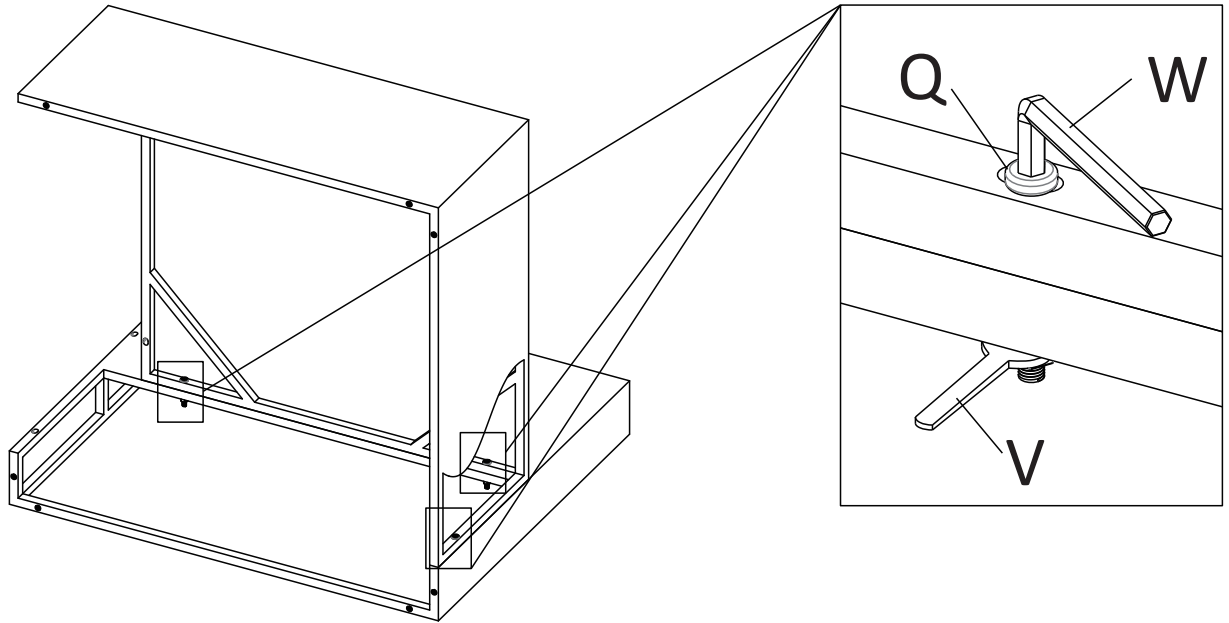

CLB x 1

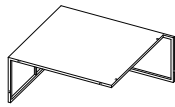

CST x 1



M6x45(Q) x 3



Washer Nut(R) x 3

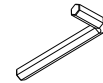

Spanner(W) x 1



Wrench(V) x 1

**Step 2: Assemble Short Back Part(CSB).**

**Tips: Screws 100% Tight This Step.**

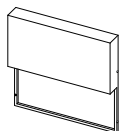
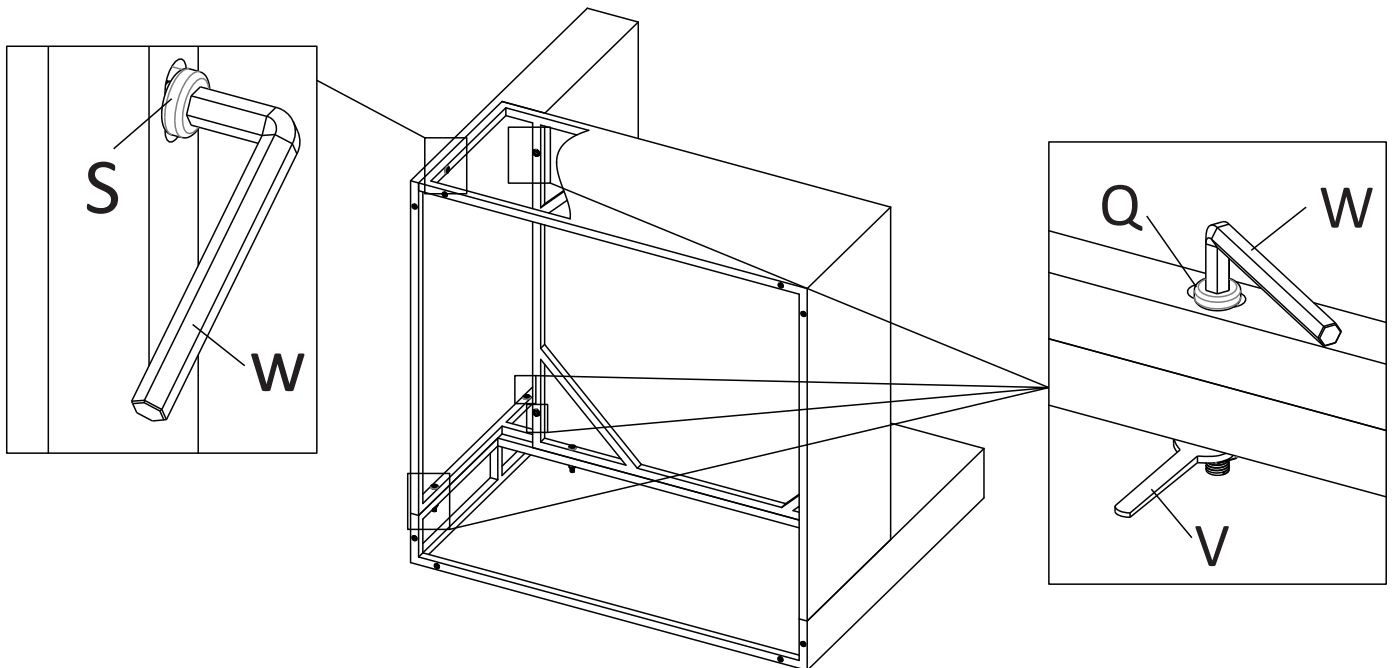

CSB x 1



M6x45(Q) x 4



Washer Nut(R) x 4



M6x30(S) x 1



Wrench(V) x 1

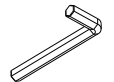

Spanner(W) x 1

# Corner Sofa



Do not use machine Two Persons together Need 25mins roughly

## Step 3: Assemble High L-Shaped Feet And Screw Feet.

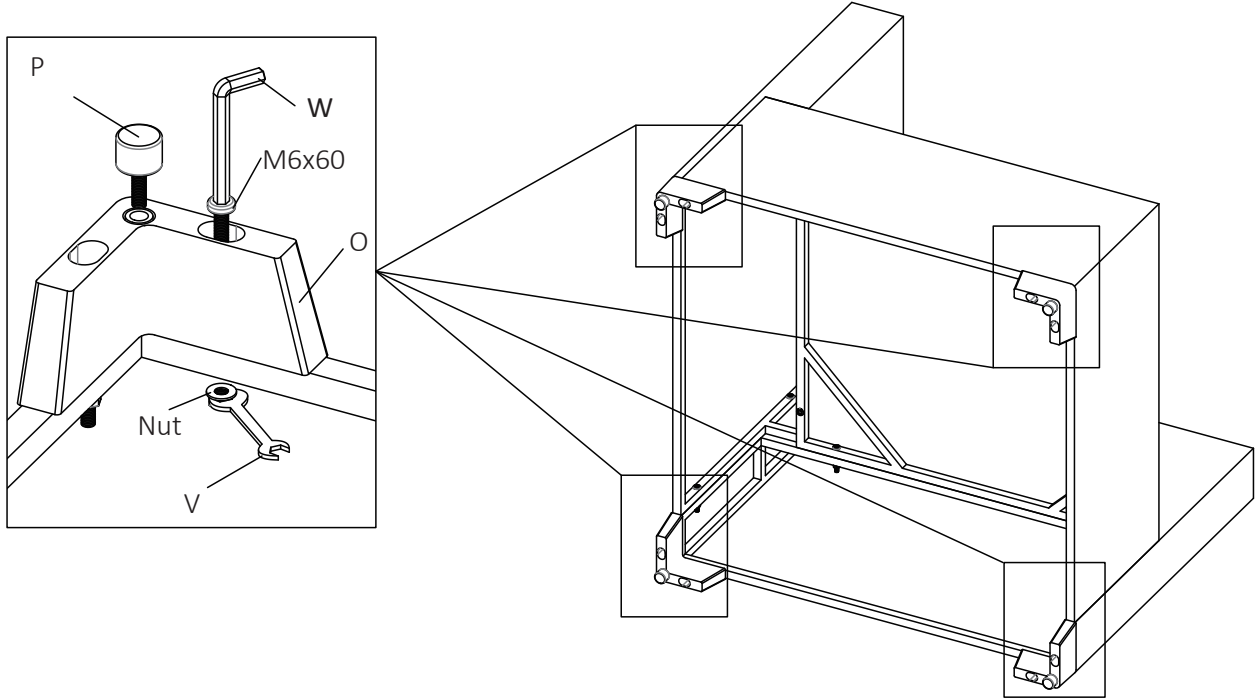

 <p>High L-Shaped Feet x 4</p>	 <p>Screw Feet(P) x 4</p>	 <p>M6x60 x 8</p>	 <p>Washer Nut(R) x 8</p>	 <p>Spanner(W) x 1</p>
--	---	--	--	---

## Step 4: Put the Seat Cushion and Back Cushion on.

Tips: The cushions can be fixed on the back of the sofa with ties. If you don't need the ties, you can cut them off.

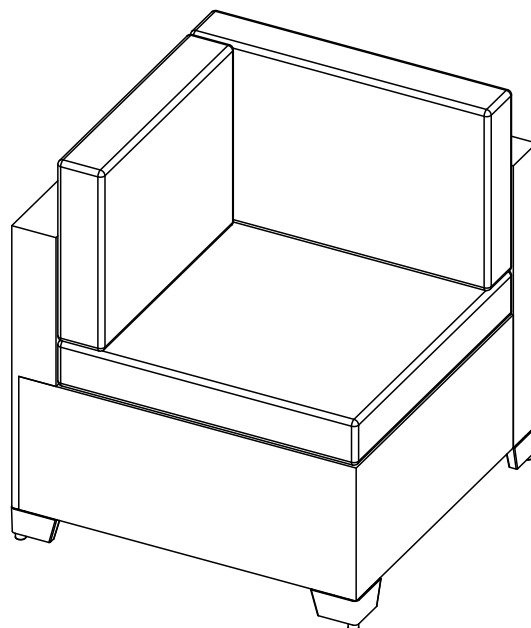

Tips:  
 Seat Cushion x 1  
 Long Back Cushion x 1  
 Short Back Cushion x 1

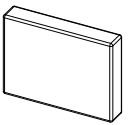
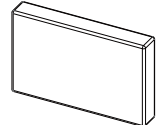
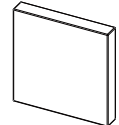
 <p>Short Back Cushion x 1</p>	 <p>Long Back Cushion x 1</p>	 <p>Seat Cushion x 1</p>
--	--	---

# Middle Sofa



Do not use machine



Two Persons together



Need 25mins roughly

## Step 1: Assemble Back Part(MBK) And Seat Part(MST).

Tips: Do not tighten 100%.

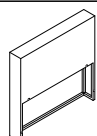
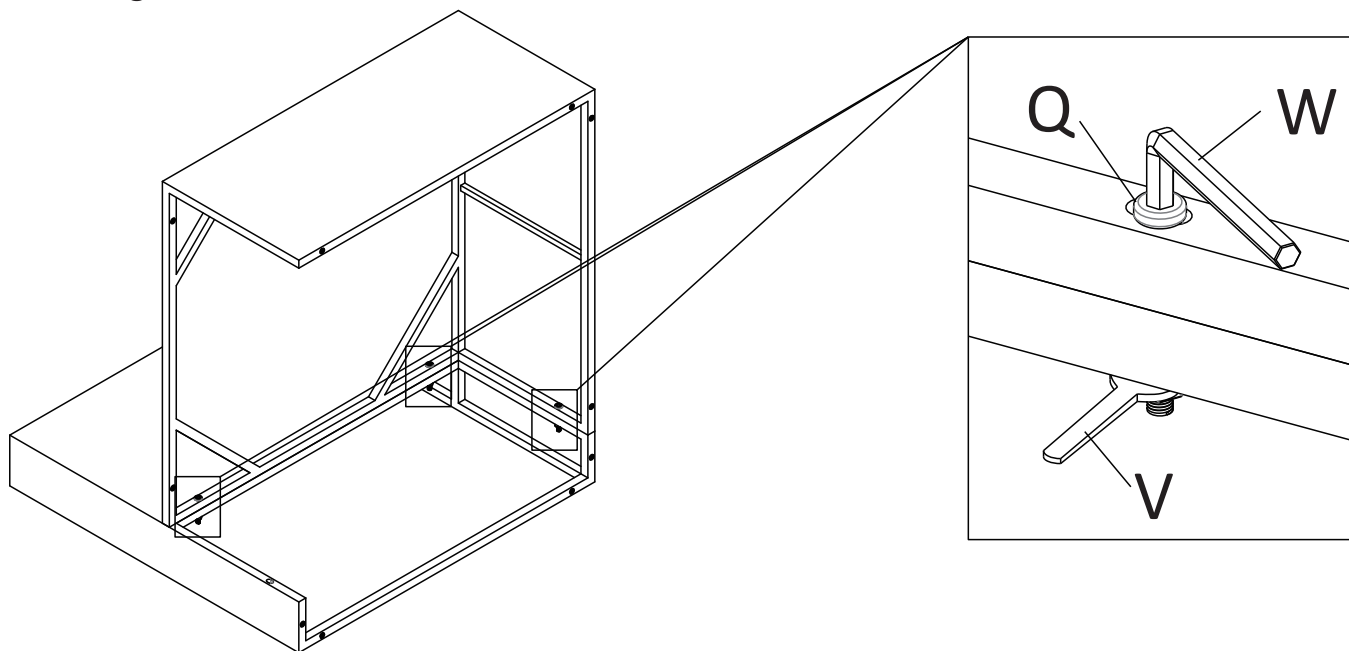

MBK x 1

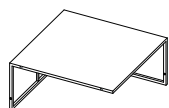

MST x 1

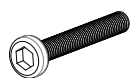

M6x45(Q) x 3



Washer Nut(R) x 3



Wrench(V) x 1

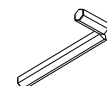

Spanner(W) x 1

## Step 2: Assemble Side Part(MSD).

Tips: Screws 100% Tight This Step.

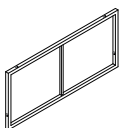
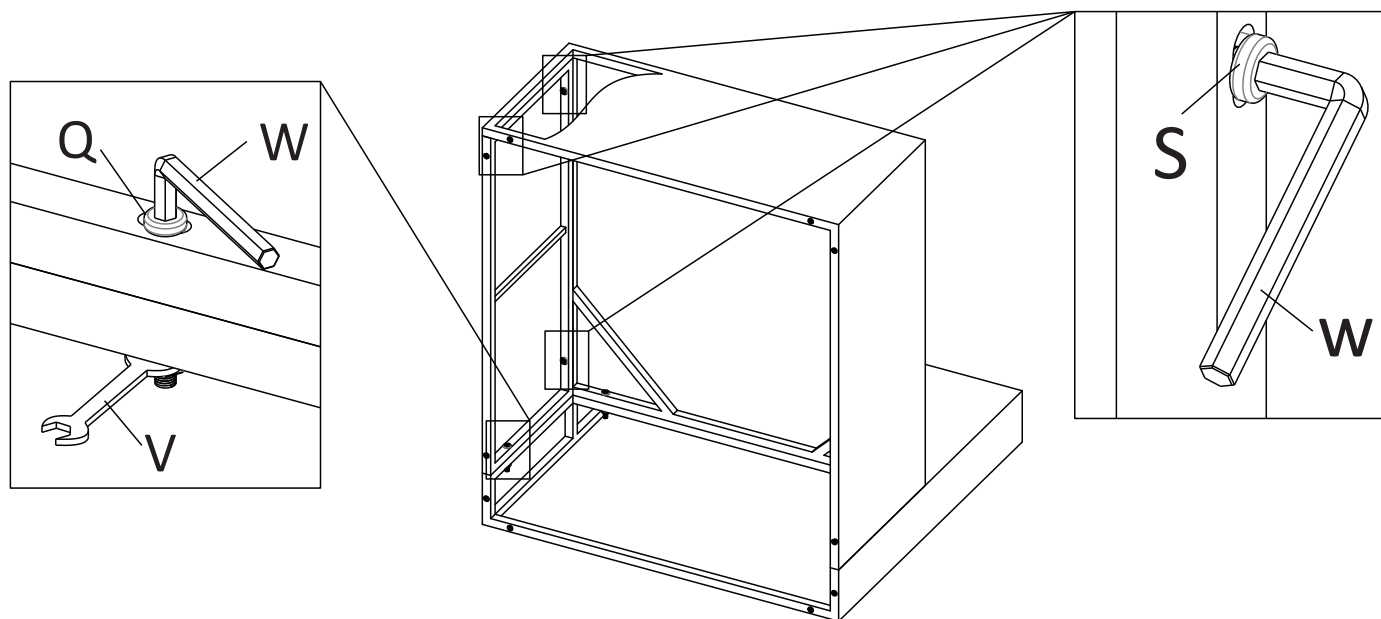

MSD x 1

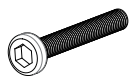

M6x45(Q) x 1



M6x30(S) x 3



Washer Nut(R) x 1



Wrench(V) x 1

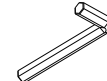

Spanner(W) x 1

# Middle Sofa



Do not use machine    Two Persons together    Need 25mins roughly

## Step 3: Assemble High L-Shaped Feet And Screw Feet.

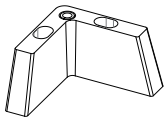
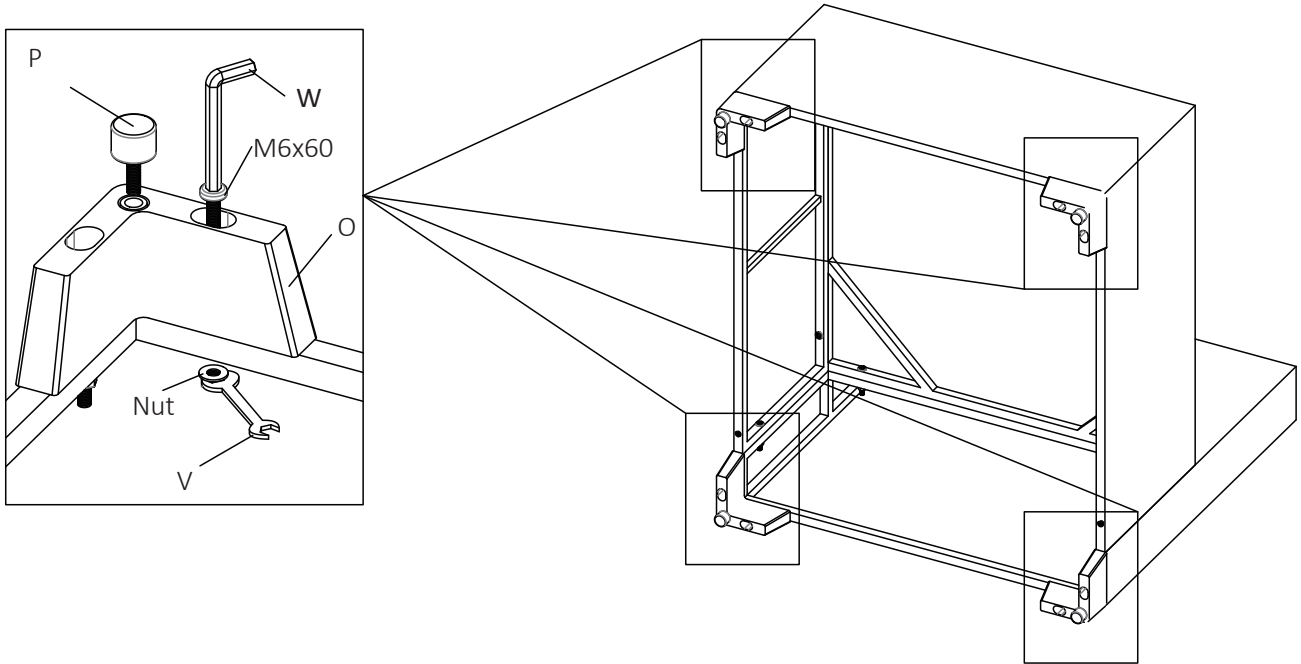

High L-Shaped Feet x 4

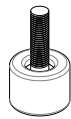

Screw Feet(P) x 4



M6x60 x 8



Washer Nut(R) x 8

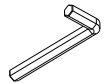

Spanner(W) x 1

## Step 4: Put the Seat Cushion and Back Cushion on.

Tips: The cushions can be fixed on the back of the sofa with ties. If you don't need the ties, you can cut them off.

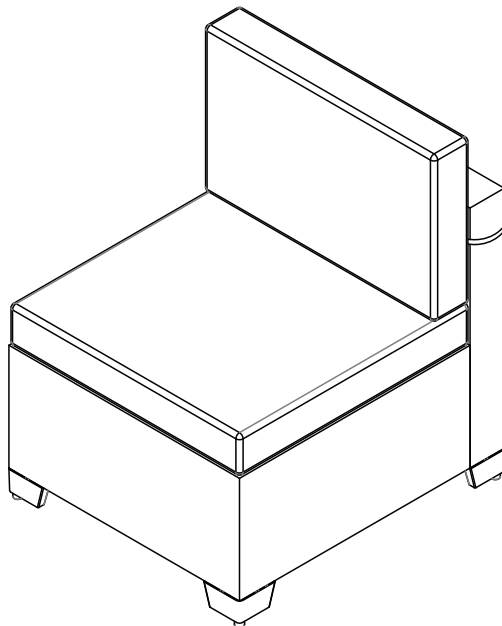

Tips:  
Seat Cushion x 1  
Long Back Cushion x 1

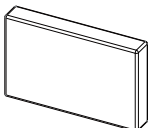

Long Back Cushion x 1

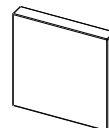

Seat Cushion x 1

# Coffee Table



Do not use machine



Two Persons together



Need 25mins roughly

## Step 1: Assemble CTL and CTS.

Tips: Do not tighten 100%.

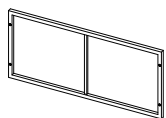
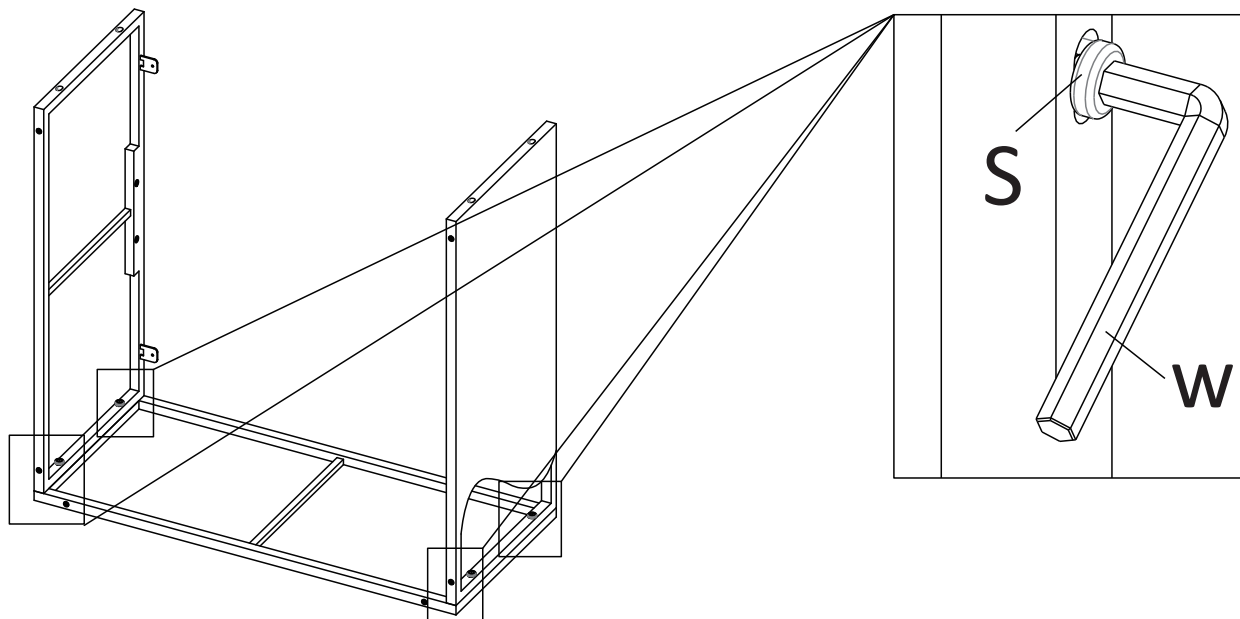

CTL x 1

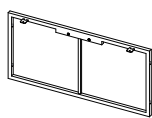

CTS x 2



M6x30(S) x 4

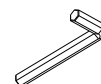

Spanner(W) x 1

## Step 2: Assemble CTC

Tips: Do not 100% tight.

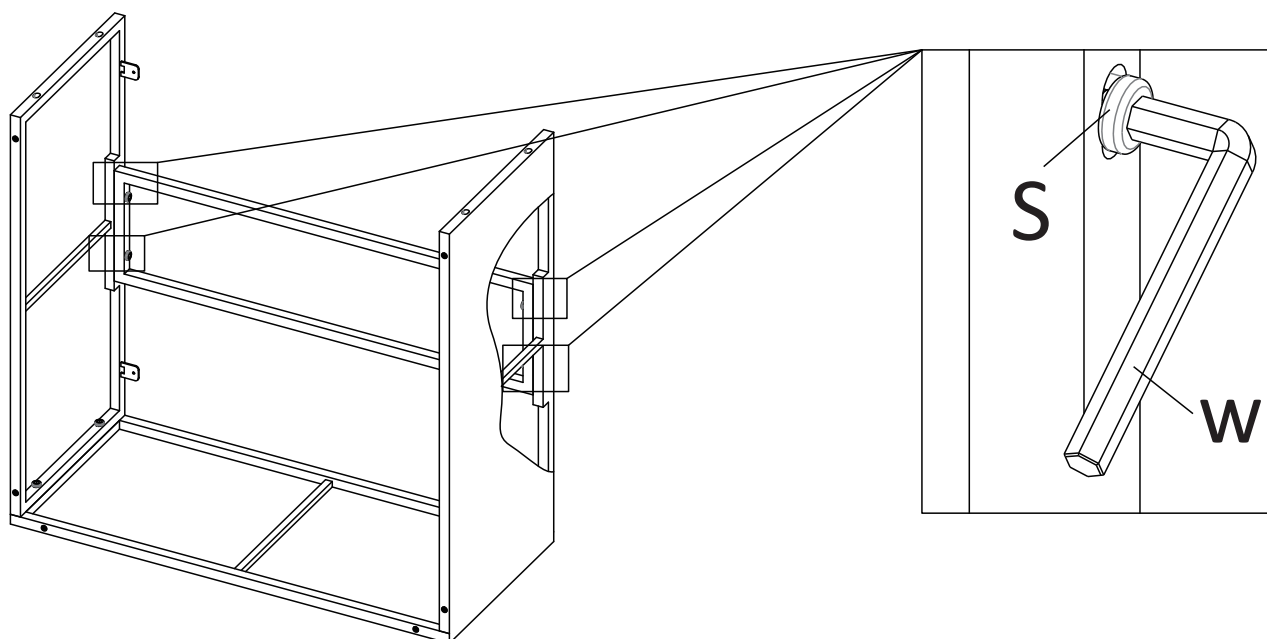

CTC x 1



M6x30(S) x 4



Spanner(W) x 1

# Coffee Table



Do not use machine    Two Persons together    Need 25mins roughly

## Step 3: Assemble CTL.

Tips: Screws 100% Tight This Step.

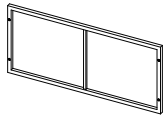
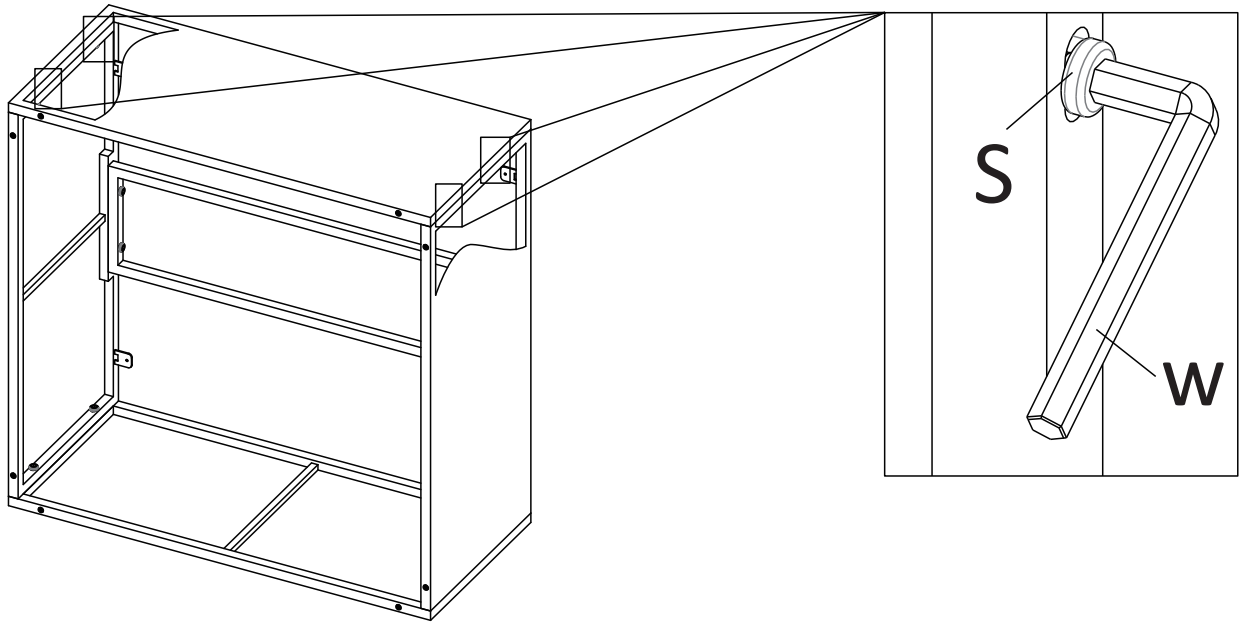

CTL x 1

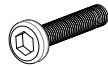

M6x30(S) x 4

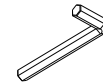

Spanner(W) x 1

## Step 4: Assemble High L-Shaped Feet.

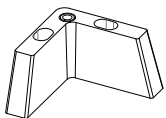
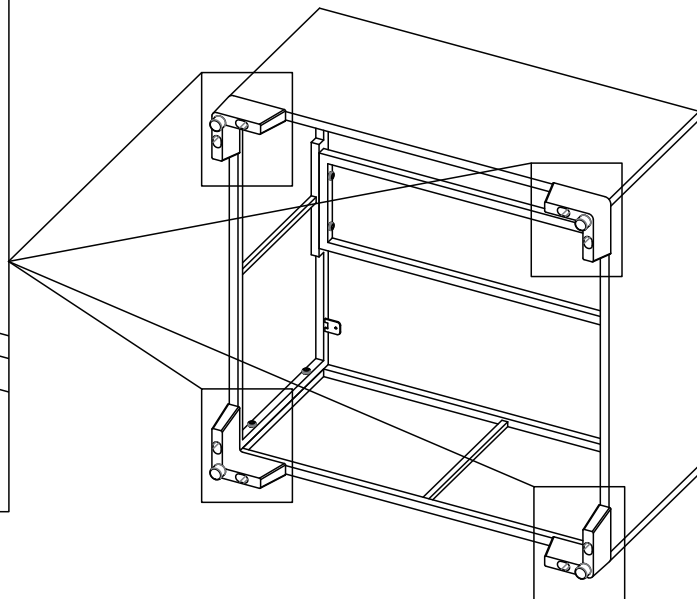
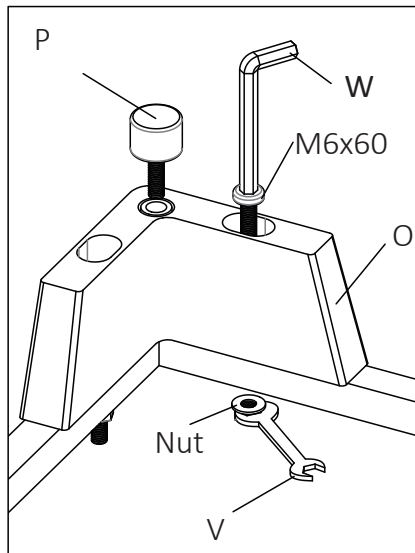

High L-Shaped Feet x 4

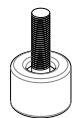

Screw Feet(P) x 4



M6x60 x 8



Washer Nut(R) x 8

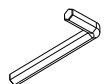

Spanner(W) x 1

# Coffee Table



Do not use machine



Two Persons together



Need 25mins roughly

## Step 5: Press in the Glass Pads.

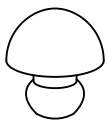
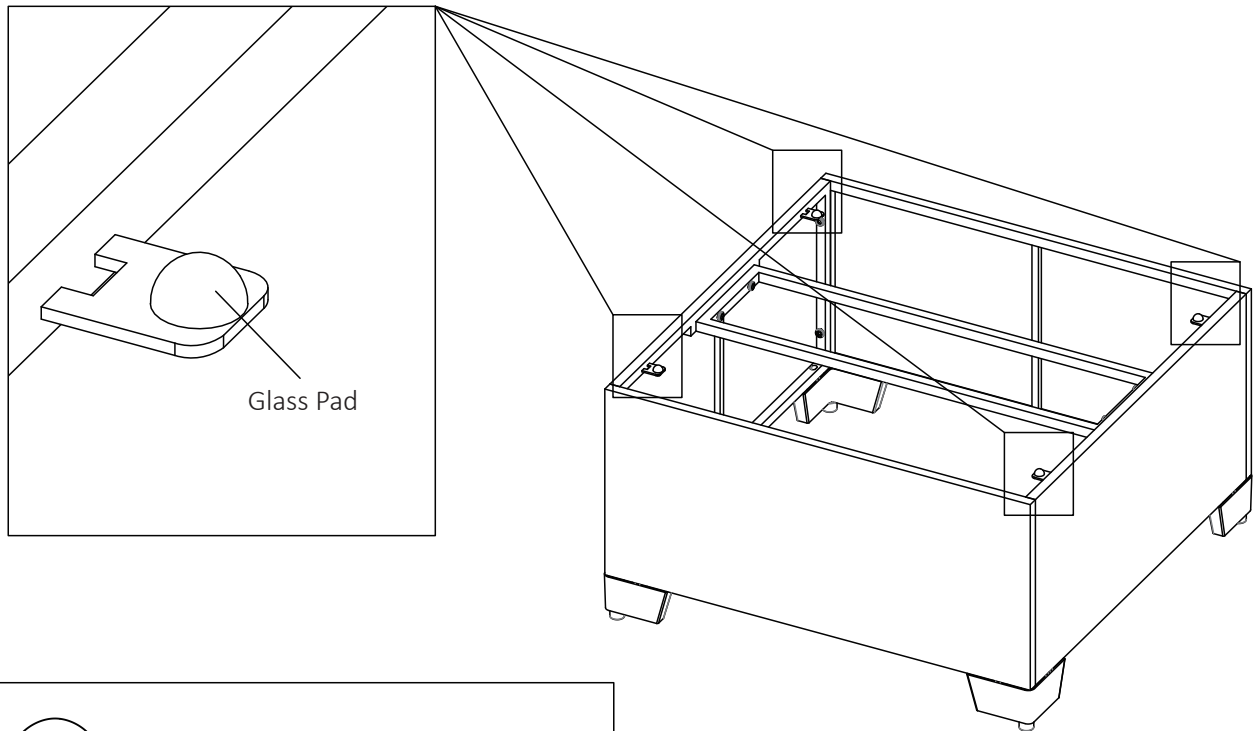

Glass Pad x 4

## Step 6: Put on the Glass Top

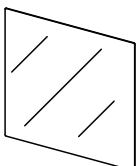
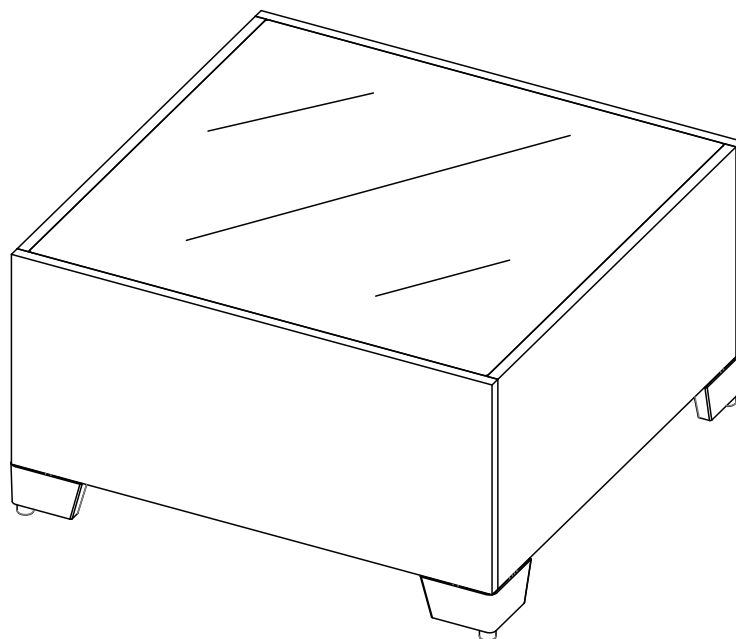

Glass Top x 1

# Accessory Replacement



Do not use machine



Two Persons together



Need 25mins roughly

Step 1: Tuck the prickly the out of the seam at the botiom of the sofa. Pull out the prickly the from the surface of the sofa to spread out and adjust to the right position.

