

Top View

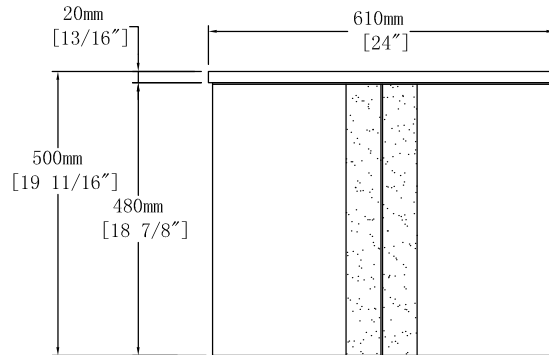

Front View

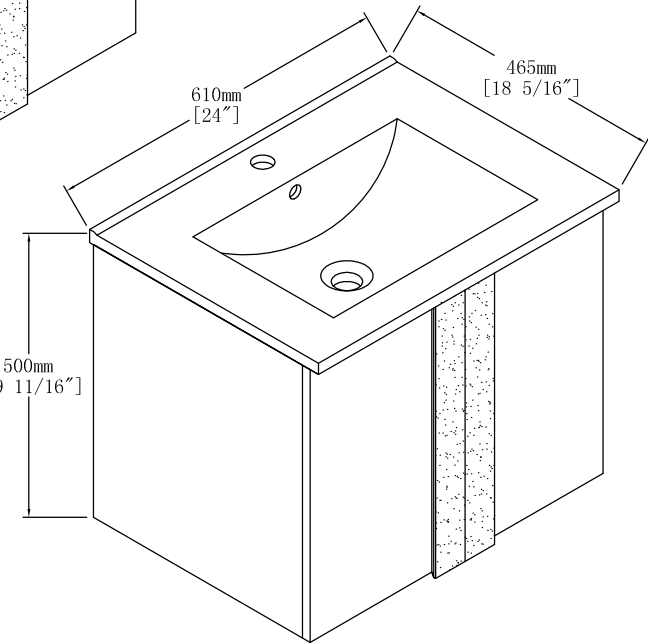
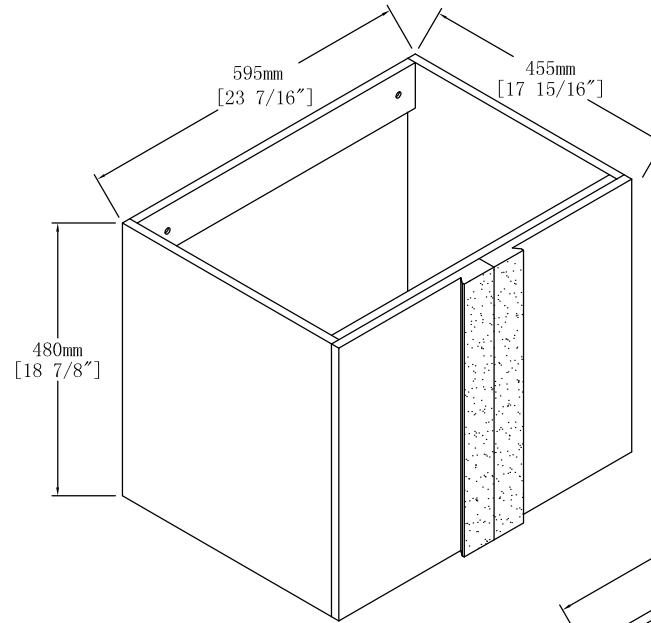
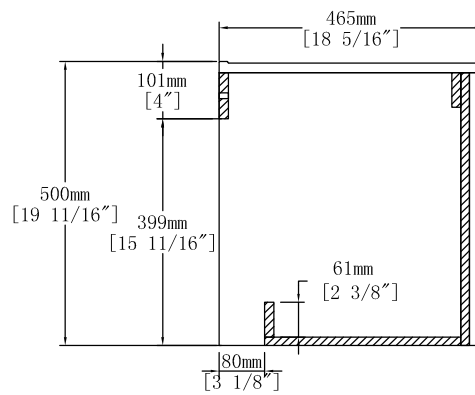

Side View

	Item NO.	UNOR VB 004 24	Version	V1
	Project		Date	2025-11-11