

FLUSHMOUNT

Assembly Instructions



CAUTION

- Inspect the wire insulation for any cuts, abrasions, or exposed copper that may have resulted during shipping. If there is a defect in the wire, do not attempt installation.
- Before starting installation of this fixture or removal of a previous fixture, disconnect the power by turning off the circuit breaker or by removing the fuse at the fuse box.

TOOLS REQUIRED



Ladder



Safety glasses



Electrical tape



Phillips screwdriver



Flat blade screwdriver



Pliers

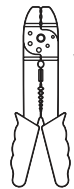

Wire strippers

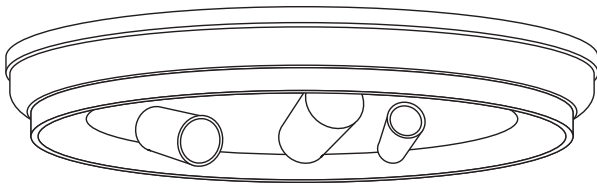

Fixture

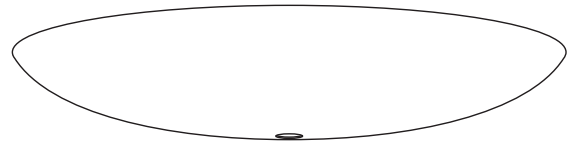

Shade



Mounting Unit

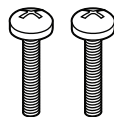

Mounting Screws

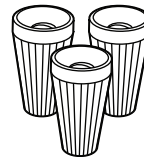

Wire Nuts



Finial

***PARTS SHOWN MAY DIFFER SLIGHTLY PER LIGHT FIXTURE**

FLUSHMOUNT

Assembly Instructions

STEP 1

Use the **mounting screws** to attach the **mounting unit** to the junction box

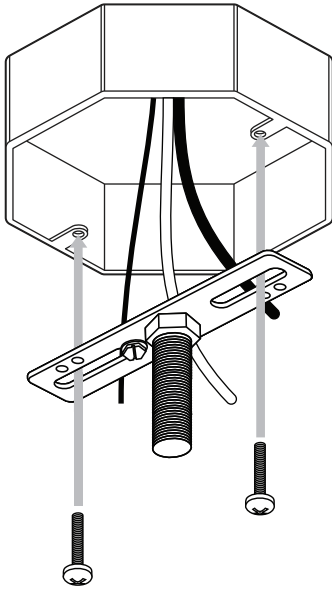

STEP 2

Make the electrical connection from the junction box to the **fixture**. Connect the ground wire to the **mounting unit** using the preinstalled green ground screw. Then, connect the positive, negative and ground wires with the supplied **wire nuts**. Secure with electrical tape

Connect Clear, Brown, Gold or Black Parallel Wire without tracer (round & smooth) or Black Fixture Wire to:

Black or Red Supply Wire or Insulated Wire (other than green) with copper conductor.

Connect Clear, Brown, Gold or Black *Parallel Wire with tracer (square & ridged) or White Fixture Wire to:

White Supply Wire or Insulated Wire (other than green) with silver conductor

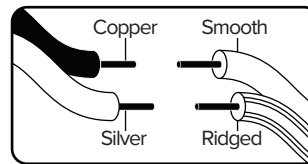
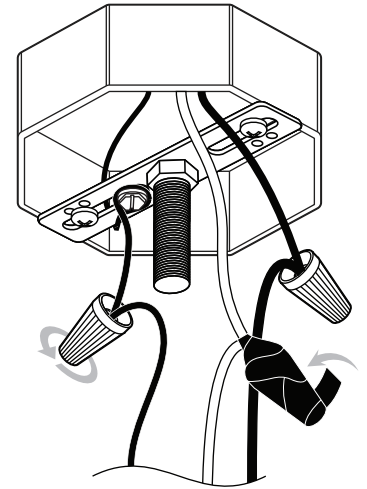

STEP 3

Install bulbs (not included). Place the **fixture** and **shade** over the **mounting unit** and secure the assembly with the **finial**.

