

Components

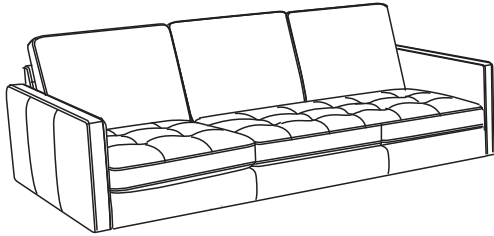

A
1X



B
6X

Assembly

1

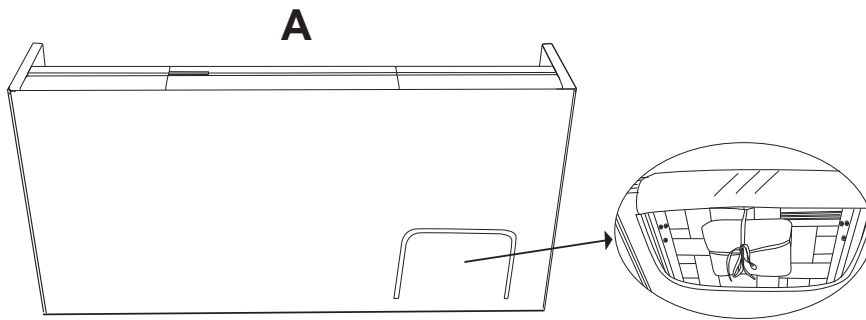

2

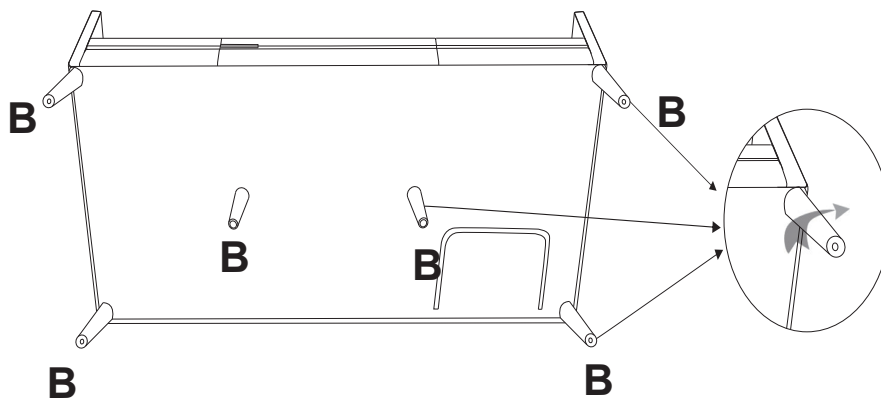

3

