

Assembly Instruction

Tabletop Fire Pit

ITEM #: CA-F1863
MODEL#: F180063-A1

ITEM #: CA-F1862
MODEL#: F180056-A1



ANS Z21.97 • CSA 2.41-2017
Outdoor Decorative Gas Appliances

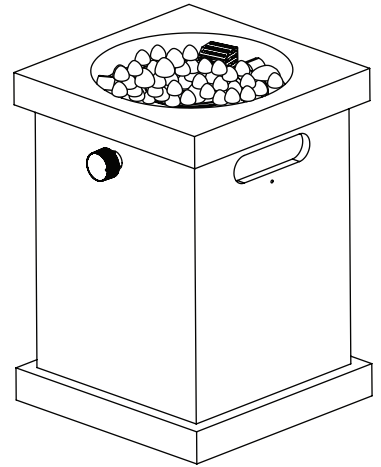
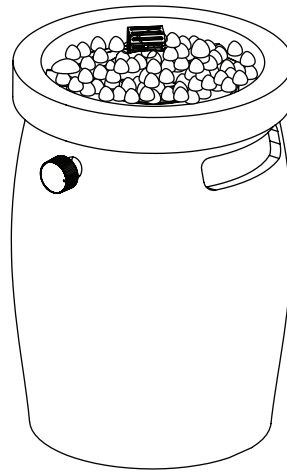

Maximum inlet supply pressure: 13 inch w.c. (3.24 kPa)
Minimum inlet supply pressure: 8 inch w.c. (1.99 kPa)

INSTALLER: Leave this manual with the appliance.
CONSUMER: Retain this manual for future reference

⚠ WARNING: For Outdoor Use Only.
Installation and service must be performed by a qualified installer, service agency, or the gas supplier.

⚠ DANGER
FIRE OR EXPLOSION HAZARD

If you smell gas:

- Shut off gas to the appliance.
- Extinguish any open flame.
- If odor continues, leave the area immediately.
- After leaving the area, call your gas supplier or fire department.

Failure to follow these instructions could result in fire or explosion, which could cause property damage, personal injury, or death.

⚠ WARNING
Do not store or use gasoline, or other flammable vapors and liquids, in the vicinity of this or any other appliance.

An LP-cylinder not connected for use shall not be stored in the vicinity of this or any other appliance.

⚠ DANGER

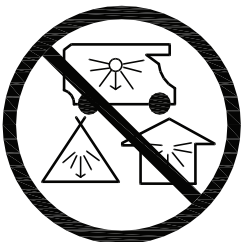

CARBON MONOXIDE HAZARD

This appliance can produce carbon monoxide which has no odor. Using it in an enclosed space can kill you.
Never use this appliance in an enclosed space such as a camper, tent, car or home.

⚠ WARNING:
If the information in this manual is not followed exactly, a fire or explosion may result causing property damage, personal injury, or loss of life.

IMPORTANT SAFETY INFORMATION

1. This appliance is for outdoor use only, and should NOT be used in a building, garage or any other enclosed area.
2. Do NOT operate, light or use this appliance within ten feet (3.05 m) of walls, structures or buildings.
3. For residential use only. This outdoor firepit is NOT for commercial use.
4. Do NOT use this outdoor firepit for indoor heating. TOXIC carbon monoxide fumes can accumulate and cause asphyxiation.
5. This outdoor firepit is safety certified for use in the United States and/or Canada only. Do NOT modify for use in any other location. Modification will result in a safety hazard and will void your warranty.
6. **Children and adults should be alerted to the hazards of high surface temperatures and should stay away to avoid burns or clothing ignition.**
7. **Young children should be carefully supervised when they are in the area of the appliance.**
8. **Clothing or other flammable materials should not be hung from the appliance or placed on or near the appliance.**
9. **Any guard or other protective device removed for servicing the appliance shall be replaced prior to operating the appliance.**
10. **Installation and repair should be done by a qualified service person. The appliance should be inspected before use and at least annually by a qualified service person. More frequent cleaning may be required as necessary. It is imperative that the control compartment, burners, and circulating air passageways of the appliance are kept clean.**
11. **CAUTION:** The propane gas pressure regulator provided with this appliance must be used. This regulator is set for an outlet pressure of 11 inches water column.
12. Apartment dwellers: Check with management to learn the requirements and fire codes for using a liquid propane (LP) gas outdoor firepit in your apartment complex. If allowed, use outside on the ground floor with a ten foot (3.05 m) clearance from any structure. Do NOT use on or under balconies.
13. This outdoor firepit, from the factory, is for use with LP gas only. The conversion to or attempted use of natural gas in this outdoor firepit is dangerous, may cause bodily harm and will void your warranty.
14. LP gas characteristics:
 - a. LP gas is flammable and hazardous if handled improperly. Become aware of the characteristics before using any LP gas product.
 - b. LP gas is explosive under pressure, heavier than air, and settles/pools in low areas.
 - c. LP gas in its natural state has no odor. For your safety, an odorant is added that smells like rotten cabbage.
 - d. Contact with LP gas can cause freeze burns to skin.
15. LP gas cylinder needed to operate. Only cylinders marked "propane" may be used.
 - a. The LP gas cylinder must be constructed and marked in accordance with the U.S. Department of Transportation (D.O.T.) Specifications for LP-Gas Cylinders, or the Standard for Cylinders, Spheres and Tubes for the Transportation of Dangerous Goods and Commission, CAN/CSA-B339 as applicable.
 - b. LP gas cylinder must be arranged for vapor withdrawal.
 - c. Never use an LP gas cylinder with a damaged body, valve, collar or footing.
 - d. Dented or rusted LP gas cylinders may be hazardous and should be checked by your LP gas supplier prior to use.
 - e. The LP gas cylinder should not be dropped or handled roughly.
 - f. Cylinders must be stored outdoors, out of the reach of children, and must not be stored in a building, garage or any other enclosed area. Your LP gas cylinder must never be stored where temperatures can reach over 125°F.
 - g. Do NOT insert any tool or foreign object into the valve outlet or safety relief valve. You may damage the valve and cause a leak. Leaking propane may result in explosion, fire, severe personal injury or death.
 - h. Never keep an LP gas cylinder in a hot car or trunk. Heat will cause the gas pressure to increase, which may open the relief valve and allow gas to escape.
 - i. Do NOT store a spare LP gas cylinder under or near this appliance.

IMPORTANT SAFETY INFORMATION

- j. A fire causing serious injury or damage to property may occur if the above is not followed exactly.
- 16. Your outdoor firepit has been checked at all factory connections for leaks. Recheck all connections as described in the “Operating Instructions” section, as shipping can loosen connections.
- 17. Check for leaks even if your unit was assembled for you by someone else.
- 18. Do NOT operate if a gas leak is present. Gas leaks may cause a fire or explosion.
- 19. You must follow all instructions in the “Checking for Leaks” section before operating. To prevent a fire or explosion when testing for a leak:
 - a. Always perform a leak test before lighting this outdoor firepit and each time the cylinder is connected for use.
 - b. No smoking. Do NOT use or permit sources of ignition in the area while conducting a leak test.
 - c. Conduct the leak test outdoors in a well-ventilated area.
 - d. Do NOT use matches, lighters or a flame to check for leaks.
 - e. The use of alcohol, prescription or non-prescription drugs may impair the consumer’s ability to properly assemble or safely operate the appliance.
 - f. Strong odors, colds, sinus congestion, etc. may prevent the detection of propane. Use caution and common sense when testing for leaks.
 - g. Do NOT use this outdoor firepit until any and all leaks are corrected.
If you are unable to stop a leak, disconnect the LP gas supply. Call a gas appliance serviceman or your local LP gas supplier.
- 20. Do NOT store or use gasoline or other flammable liquids or vapors within 25 feet (7.62 m) of this appliance.
- 21. Do NOT use in an explosive atmosphere. Keep outdoor firepit area clear and free from combustible materials, gasoline and other flammable vapors and liquids.
- 22. This outdoor firepit is NOT to be operated by children.
- 23. This outdoor firepit is NOT to be used in or on boats or recreational vehicles.
- 24. Do NOT connect to a remote gas supply.
- 25. Never attempt to attach this outdoor firepit to the self-contained LP gas system of a camper trailer, motor home or house.
- 26. Always use in accordance with all applicable local, state and national codes. Contact your local fire department for details on outdoor burning. When using this outdoor firepit, exercise the same precautions you would with any open fire.
- 27. Do NOT use this outdoor firepit without reading the entire Owner’s Manual.
- 28. Do NOT burn solid fuels such as: wood, charcoal briquettes, lump charcoal, manufactured logs, driftwood, trash, leaves, paper, cardboard, plywood, painted/stained/pressure treated wood in this outdoor firepit.
- 29. It is essential to keep the outdoor firepit’s valve compartment, burners, and circulating air passages clean. Inspect outdoor firepit before each use.
- 30. Do NOT use this outdoor firepit until it is COMPLETELY assembled and all parts are securely fastened and tightened.
- 31. Do NOT use this outdoor firepit near automobiles, trucks, vans or recreational vehicles.
- 32. Do NOT use this outdoor firepit under any overhang or near any unprotected combustible constructions. Avoid using near or under overhanging trees and shrubs.
- 33. Do NOT use this outdoor firepit for cooking.
- 34. Do NOT use this appliance if any part has been under water. Immediately call a qualified service technician to inspect the appliance and to replace any part or control system and any gas control which has been under water.
- 35. Do NOT wear flammable or loose clothing when operating this outdoor firepit.
- 36. Do NOT use in windy conditions.
- 37. Never lean over this outdoor firepit when lighting or when in use.
- 38. Do NOT use this outdoor firepit unless burner is securely in place.
- 39. Keep all electrical cords away from this outdoor firepit during use.

IMPORTANT SAFETY INFORMATION

40. Certain areas of this outdoor firepit when in use will become too hot to touch. To avoid burns, do NOT touch hot surfaces until the unit has completely cooled, unless you are wearing protective gear (such as insulated pot holders or heat-resistant gloves/mittens).
41. Do NOT leave a lit outdoor firepit unattended, especially around children and pets.
42. Do NOT hang or place clothing or other flammable material on or near this appliance.
43. If applicable, protective cover must be removed when burner is in operation.
44. Do NOT attempt to move outdoor firepit when in use. Allow the outdoor firepit to cool before moving or storing.
45. This outdoor firepit should be thoroughly cleaned and inspected on a regular basis. Inspect the burner before each use of the appliance. If there is evidence of burner damage, the burner must be replaced prior to the appliance being operated. Use only the burner specified by Xiamen Ecotop Industrial Co.,Ltd.
46. This outdoor firepit should be inspected at least annually by a qualified service person. Depending on amount of use, more frequent cleaning may be required. Do NOT operate until all parts have been repaired or replaced.
47. Use only the regulator assembly provided. Use only the replacement regulator assembly specified by Use only the burner provided. Use only the replacement burner specified by Xiamen Ecotop Industrial Co.,Ltd.
48. Use only Xiamen Ecotop Industrial Co.,Ltd. factory-authorized parts. The use of any part that is not factory authorized can be dangerous and will void your warranty.
49. Do NOT operate this appliance without reading "Operating Instructions" in this manual.
50. Storage of this outdoor firepit indoors is permissible only if the cylinder is disconnected, removed from the outdoor firepit and properly stored outdoors.
51. Do NOT attempt to disconnect the gas regulator from the cylinder or any gas fitting while the outdoor firepit is in use.
52. The propane gas supply cylinder must be disconnected when this appliance is not in use.
53. The pressure regulator is set for 11 inches of water column.
54. The maximum inlet gas pressure for this outdoor firepit is 11 inches of water column.
55. Before pressure testing, close LP gas cylinder valve and disconnect gas regulator. The gas supply piping system must test at pressures equal to or less than 1/2 psi (3.5 kPa).
56. Do NOT sit or stand on the mantle or any part of this appliance.
57. Do NOT throw anything onto the fire when the unit is in operation.
58. Fire logs, glass and lava rock are very hot. Keep children or pets at a safe distance from this appliance.
59. The opening of the cylinder collar should face toward the door side for easy access.
60. Do NOT store any combustible materials in the base enclosure.
61. Use protective gloves when assembling this product.
62. Do NOT force parts together as this can result in personal injury or damage to the product.
63. Death, serious injury or damage to property may occur if the above is not followed exactly.

PACKAGE CONTENTS

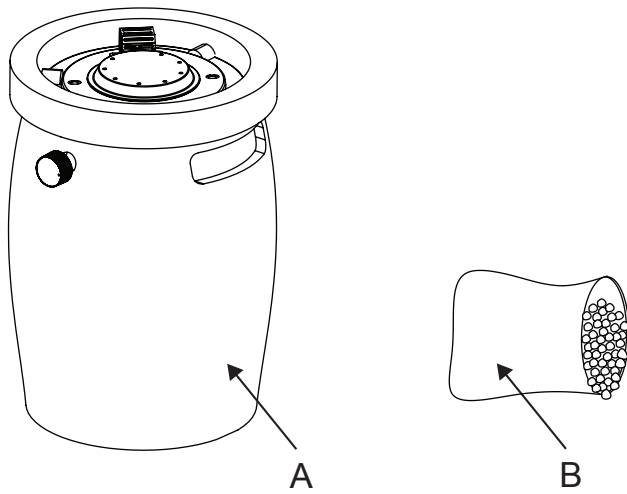

PART#	DESCRIPTION	QUANTITY
A	Fire pit body	1
B	Lava rock (1.1 lbs)	1 bag

ASSEMBLY INSTRUCTIONS

1. Carefully unpack all parts from the box, compare parts with package content listed above, make sure all parts are present before beginning assembly of product. If any part is missing or damaged, do not attempt to assemble the product. Contact customer service for replacement parts.
2. Check that the control knob is turned to the "OFF" position before starting any assembly (See Figure 1).

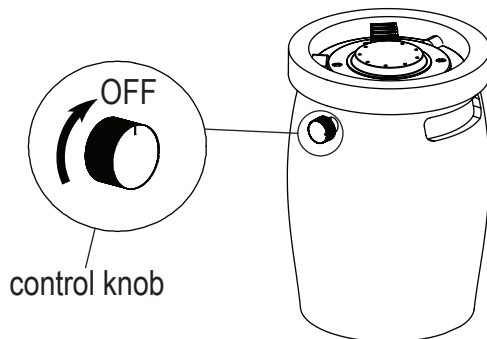

Figure 1

3. Installing LP Gas Cylinder
This firepit is designed to operate with a 1 lb. / 16.4 oz. propane gas cylinder (DOT 39 Cylinder) (See Figure 2). **DO NOT ATTEMPT TO REFILL ANY 1 lb. (16.4 oz.) PROPANE GAS CYLINDERS!**

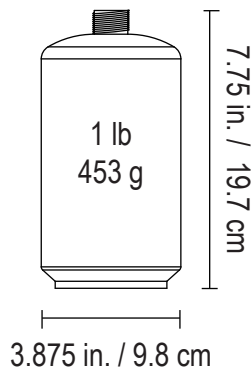

Figure 2

4. Connecting propane cylinder (See Figure 3)

Only cylinders marked “propane” may be used.

NOTE: Some 1 lb cylinders may form frost when near empty.

- (1). Before connecting, be sure there is no debris caught in the head of the burner or burner or burner ports.
- (2). Make sure the control knob is in the “ OFF” position.
- (3). Lubricate the threads of the regulator with petroleum jelly. Line up threads on the propane cylinder with regulator.
- (5). Insert the propane cylinder.
- (6). Rotate the propane cylinder clockwise until they fit snugly together. **HAND TIGHTEN ONLY**. Be careful not to crossthread when screwing in cylinder.
- (7). Perform leak test per “Checking for Leaks” section.

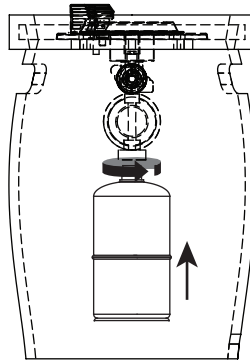

Figure 3

5. Disconnecting propane cylinder (See Figure 4)

- (1). Turn the control knob to the “ OFF” position .
- (2). Rotate propane cylinder counterclockwise until it is loose.
- (3). Remove the propane cylinder.
- (4). Store the propane cylinder in a proper location.
- (5). Place the protective cap cover on the propane cylinder and store the cylinder outdoors in a well ventilated area out of direct sunlight.

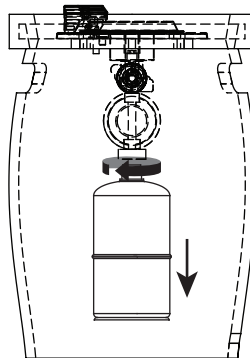

Figure 4

6. Place the lava rocks (B) into the fire pit body (A). Approx lava rock 1.1 lbs of lava rocks are needed (See Figure 5) .

NOTE: leave the pilot box uncovered by lava rock.

CAUTION: this fire pit is equipped with natural lava rock that may crackle or pop the first time it is used. Lava rock has been pre-heat treated. However, in rare cases on first time use, lava rock may pop or burst causing small pieces of hot rock to fly out of the fire pit. These hot pieces could strike somebody's face during the process of lighting the fire pit, stay away from the fire pit for the first 20 minutes after igniting.

⚠ WARNING

Keep children away during assembly, as this item contains lava rocks, which are small pieces and can be swallowed by children.

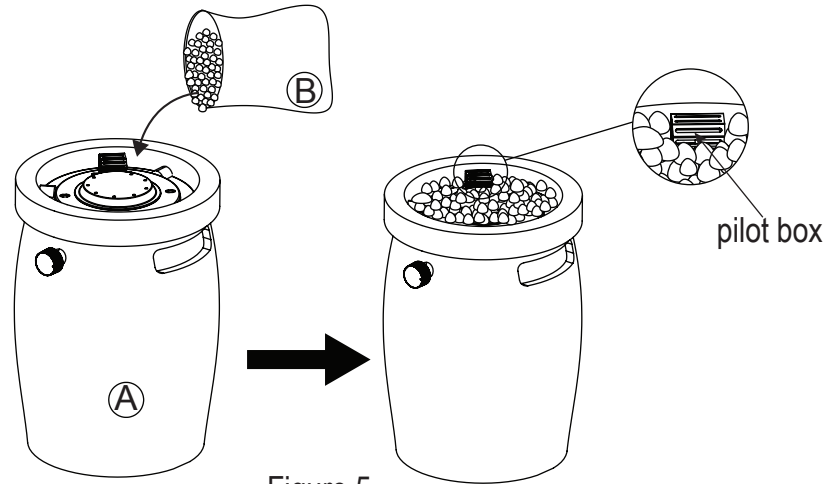

Figure 5

OPERATING INSTRUCTIONS

Checking for leaks

⚠ WARNING:

Before using this outdoor firepit, make sure you have read, understand and are following all information provided in the “Safety Information” section beginning on page 2 and 3. Failure to follow those instructions can cause death, serious injury or property damage.

Burner connections

1. Make sure the valve connections are securely fastened to the burner and the cylinder.
2. Visually check the connection between the burner/venturi tube and orifice.
3. Make sure the burner/venturi tube fits over the orifice.
4. Please refer to diagram for proper installation (See Figure 6).
5. If the burner/venturi tube does not rest flush to the orifice as shown, please contact us for assistance.

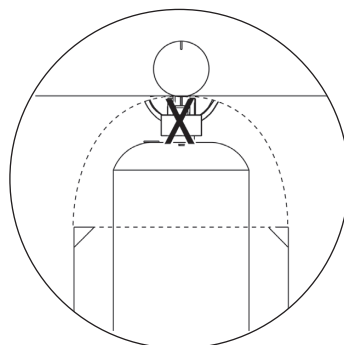

Figure 6

OPERATING INSTRUCTIONS

⚠ WARNING:

Failure to inspect this connection or follow these instructions could cause a fire or an explosion which can cause death, serious bodily injury or damage to property.

Cylinder/Gas line connection

1. Make 2-3 oz. of leak detection solution by mixing one part liquid dishwashing soap with three parts water.
2. Make sure regulator/control knob is in the “OFF” position as shown (See Figure 7).
3. Apply the leak detection check solution on the “X” location as shown (See Figure 6).
 - a. If any bubbles appear, remove the LP gas cylinder and reconnect, make sure the connection is secure.
 - b. If you continue to see bubbles after several attempts, remove the LP gas cylinder per “Disconnect LP Gas Cylinder” section and contact us for assistance.
 - c. If no bubbles appear after one minute, turn regulator/control knob to the “OFF” position, wipe away solution and proceed.

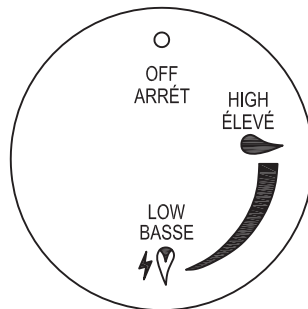

Figure 7

Lighting

⚠ CAUTION:

Do NOT obstruct the flow of combustion and ventilation air.

⚠ WARNING:

NEVER light the burner with a cover on the outdoor firepit.

⚠ CAUTION:

Keep outdoor gas appliance area clear and free from combustible materials, gasoline and other flammable vapors and liquids.

⚠ CAUTION:

Check and clean burner/venturi tubes for insects and insect nests. A clogged tube can lead to a fire.

1. Make sure all packagings have been removed from the outdoor firepit.
2. Check for obstructions of airflow to the burner Spiders, insects and webs can clog the burner/venturi tube. A clogged burner tube can lead to a fire.
3. Control knob must be in the “OFF” position.
4. Clear small area of lava rocks away from the igniter cover.
5. Connect propane cylinder per “Connecting Propane Cylinder” section.

6. Push and turn control panel counterclockwise to “High” position (See Figures 8).
7. Use a match or a lighter to light the fire bowl.
8. Adjust flame to desired height with the control knob.
9. After lighting, observe the burner flame. Make sure all burner ports are lit and flame height matches illustration (See Figures 9-11).

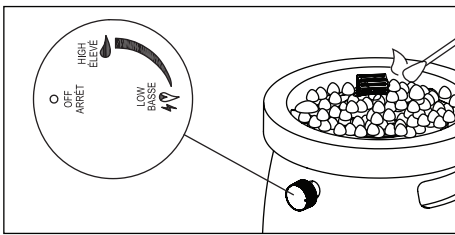

Figure 8

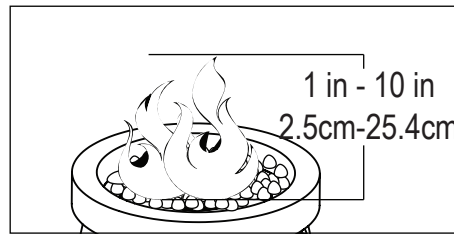
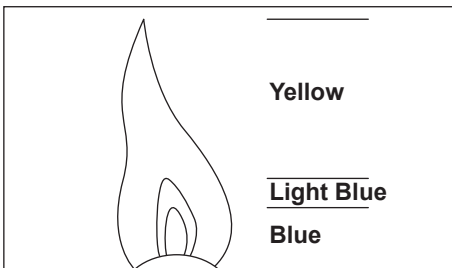
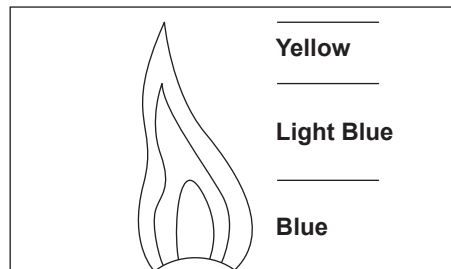

Figure 9



Bad

Figure 10



Good

Figure 11

⚠ CAUTION:
Disconnect propane cylinder when this appliance is not in use.

⚠ CAUTION:
If ignition does not occur in 5 seconds, turn control knob to “OFF” wait 5 minutes, fan with a newspaper or magazine, and repeat lighting procedure.

Turning off

1. Turn and push the control knob clockwise to the “OFF” position.
2. Disconnect propane cylinder per “Disconnecting propane cylinder” section. If ignition does NOT immediately take place in seconds, push and turn the control knob clockwise to “OFF” position. Wait 5 minutes and then repeat the lighting procedures as above.

NOTE: A “poof” sound is normal as the last of the LP gas is burned.

⚠ CAUTION:
Certain areas of this outdoor fire column when in use will become too hot to touch. To avoid burns, do not touch hot surfaces until the fire column has completely cooled down.

CARE AND MAINTENANCE

CAUTION:

1. All cleaning and maintenance should be done when outdoor firepit is cool and with the fuel supply disconnected.
2. Do NOT clean any outdoor firepit part in a self-cleaning oven. The extreme heat will damage the finish.
3. Do NOT enlarge valve orifices or burner ports when cleaning the valves or burners.

NOTES

1. This outdoor firepit should be thoroughly cleaned and inspected on a regular basis.
2. Abrasive cleaners will damage this product.
3. NEVER use oven cleaner to clean any part of this outdoor firepit.

Before Each Use:

1. Keep the outdoor firepit area clear and free from any combustible materials, gasoline, and other flammable vapors and liquids.
2. Do NOT obstruct the flow of the combustion of LP gas and the ventilation of air.
3. Keep the ventilation opening(s) of the LP gas cylinder area free and clear from debris.
4. Visually check the burner flames to make sure your outdoor firepit is working properly (See Figure 11).
5. See below for proper cleaning instructions.
6. Check all gas connections for leaks.
7. Check components for any signs of damage or rust.
8. Check for obstructions of airflow to the burner Spiders, insects and webs can clog the burner/venturi tube
A clogged burner/venturi tube can lead to a fire.
9. If damage to any component is detected, do NOT operate until repairs are completed.

Cleaning Surfaces

1. Wipe surfaces clean with mild dishwashing detergent or baking soda mixed with water.
2. For stubborn stains, use a citrus-based cleaner and a nylon scrubbing brush.
3. Rinse clean with water.
4. Allow to air dry.

Before Storing

1. Turn control knob to the "OFF" position.
Note: A "poof" sound is normal as the last of the gas is burned.
2. Disconnect LP gas cylinder per "Disconnecting LP Gas Cylinder" section.
3. Clean all surfaces.
4. Lightly coat the burner with cooking oil to prevent excess rusting.
5. If storing the outdoor firepit indoors, cover the outdoor firepit and store it in a cool dry location away from children and pets
6. If storing the outdoor firepit outdoors, cover the outdoor firepit with a cover for protection from the weather.

 **CAUTION: NEVER place a cover on hot outdoor firepit.**

WARRANTY

Firepits

Burner, steel fire pit bowl, all mechanical parts and fittings to control panel and burner assembly, and all fire pit tops that are not cast aluminum are warranted for a period of one (1) year from original date of purchase, against defects in material and or workmanship. Rust is not covered.

Frames

Frames are warranted to be free from defects in materials and workmanship for a period of one (1) year. Damage to frames or welds due to improper assembly or exposure to water and sub-freezing temperatures, is not covered. Breakage that is a result of product being dropped, acts of God, acts of war, etc. are not covered.

Finish

The finish is warranted against peeling, cracking, or blistering for a period of one (1) year provided the product has not been scratched or abraded. Scratches and chips resulting from normal wear and tear are not covered. Fading resulting from exposure to elements is not covered. Stains as a result of chemical spills and certain food items are not covered.

Table Tops

All table tops are warranted for a period of one (1) year from original date of purchase, against defects in material and or workmanship. Breakage, discoloration, staining, and or any other weather related issues are not covered.

Warranty Exclusions

Failure caused by unreasonable or abusive use. Firepits that were clearance items, display models or items purchased in an "as is" condition, freight damage, firepit damaged by acts of nature, vandalism, fire, abuse, lack of proper care and maintenance, or improper assembly; straps and normal fading or discoloration from exposure to elements, oils, spills, fluids or chemicals; Table top against breakage; hardware against corrosion or rusting; buckling or splitting of tubing resulting from exposure to water and freezing temperatures; glass table tops, purchased or replacement parts; plastics. Also excluded: loss of use of time and or inconvenience, money, travel, packaging or any other consequential or incidental damages. In no event shall Xiamen Ecotop Industrial Co., Ltd. responsibility exceed the value of the replacement product. Warranty is to the original purchaser when items are purchased from one of our authorized retailers and is not transferable. All warranty claims must be submitted with a dated register receipt within the warranty period. Should replacement of the warranted item be unavailable, Xiamen Ecotop Industrial Co., Ltd. reserves the right to substitute items of our choice similar in style, color and quality. For quality control purposes and verification, we reserve the right to request photographs of the damage item(s). The terms of this warranty are subject to change without notice.

Customer Service Before Return:

If part missing or damaged, or you need help with assembly, please do not hesitate to contact us.

Website: www.casainc.com

Contact Phone Number: 888-257-3857

Service Contact : service@casainc.com

