



IMPORTANT, RETAIN FOR FUTURE REFERENCE: READ CAREFULLY

# ASSEMBLY & INSTRUCTION MANUAL

# Garden Chairs

## **IMPORTANT, RETAIN FOR FUTURE REFERENCE: READ CAREFULLY**

**Only for domestic use**

### **Use tips:**

- \* Maximum Weight Capacity of Chair: 160 Kg
- \* Maximum Weight Capacity of Table: 30 Kg
- \* Put the chair stably on a flat floor.
- \* Mount the garden chairs in the shelter of the weather.
- \* Stay away from open flames.
- \* Don't hang anything in the structure.
- \* Avoid the overload at the anchors/structure.
- \* It is advised that don't stay on the chairs when there is a storm.
- \* Do not use in adverse weather condition and cover furniture when not in use.

### **Precautions before assembly:**

- \* Prepare a clean and dry mounting area.
- \* Verify that the product is not damaged.
- \* Check that none of the pieces are missing.

### **Maintenance:**

- \* Clean with a soft fabric.
- \* Regularly remove leaves and / or water collected on the canvas.
- \* Check the chair regularly.

### **Storage conditions:**

\* The fabric should be stored completely dry, in a clean and dry place to avoid the risks of mold.

### **Caution with the risks of pinching or cuts during assembly.**

**The manufacturer declines all responsibility in case of damages due to a bad installation or due to weather.**

# Chaises de jardin

## **IMPORTANT - CONSERVEZ CES INFORMATIONS POUR VOTRE CONSULTATION ULTÉRIEURE: LISEZ ATTENTIVEMENT**

**Seulement pour usage domestique**

### **Conseils:**

- \* Poids maximum admissible de la chaise: 160 Kg
- \* Poids maximal admissible de la table: 30 Kg
- \* Pour une performance optimale, veuillez le poser sur une surface plane.
- \* Installer la chaise sous l'auvent.
- \* Maintenez à l'écart de toute flamme nue.
- \* Évitez de suspendre des matériaux sur le meuble.
- \* Veuillez à ne pas dépasser les capacités de poids maximales.
- \* Il est conseillé de ne pas rester sur la chaise en cas d'orage.
- \* Ne pas utiliser dans des conditions météorologiques défavorables et couvrir les meubles lorsqu'ils ne sont pas utilisés.

### **Précautions avant l'assemblage:**

- \* Préparez une zone de montage propre et sèche.
- \* Vérifiez que le produit n'est pas endommagé.
- \* Vérifiez qu'aucun des morceaux ne manque.

### **Recommandations d'entretien:**

- \*Veuillez utiliser un chiffon doux pour essuyer la chaise.
- \*Veuillez nettoyer régulièrement l'eau stagnante du fauteuil
- \*Veuillez vérifier régulièrement la chaise pour éviter une structure lâche.

### **Conditions de stockage:**

- \*Lorsqu'ils ne sont pas utilisés, les meubles doivent être recouverts d'une housse appropriée.

**Veuillez faire attention à ne pas vous blesser lors de l'assemblage du produit.**

**Le fabricant n'est pas responsable des dommages causés par une mauvaise installation.**

**PARTS**

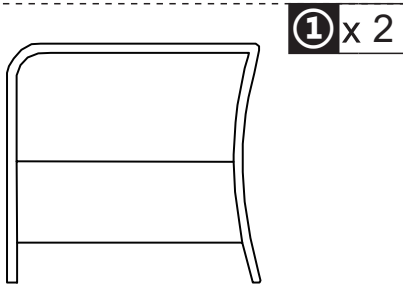

**1** x 2

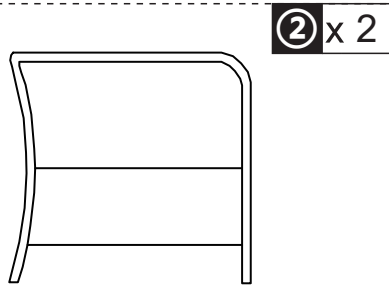

**2** x 2

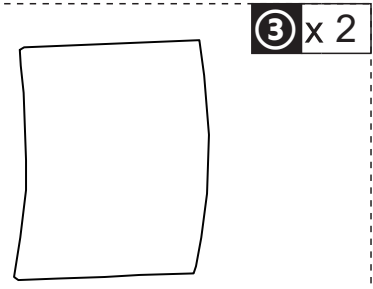

**3** x 2

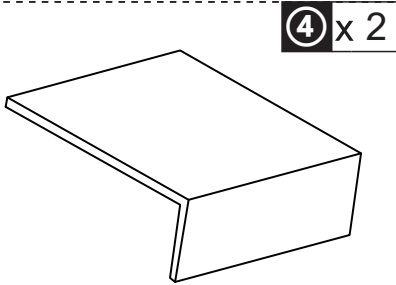

**4** x 2

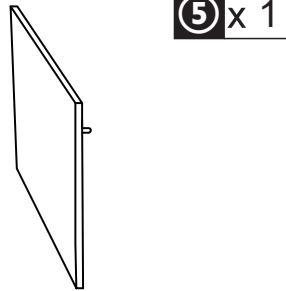

**5** x 1

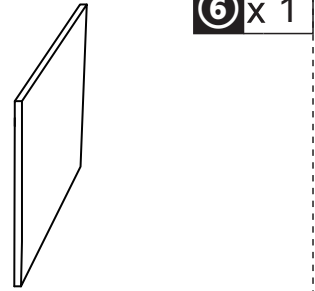

**6** x 1

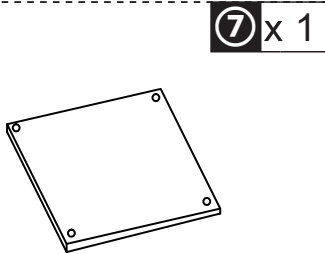

**7** x 1

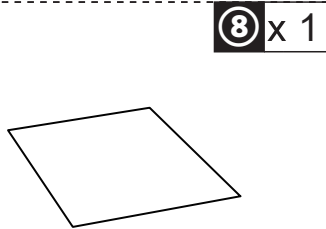

**8** x 1

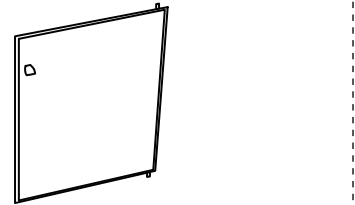

**9** x 1

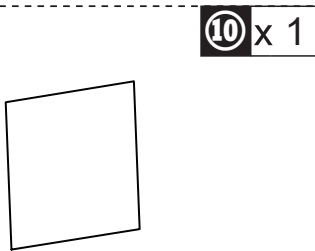

**10** x 1

**HARDWARE**

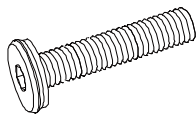

**A** x 22  
M6x40mm  
+2 (spare)

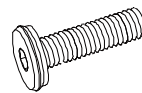

**B** x 12  
M6x35mm  
+1 (spare)



**C** x 34  
M6  
+3 (spare)



**D** x 2  
M6

01

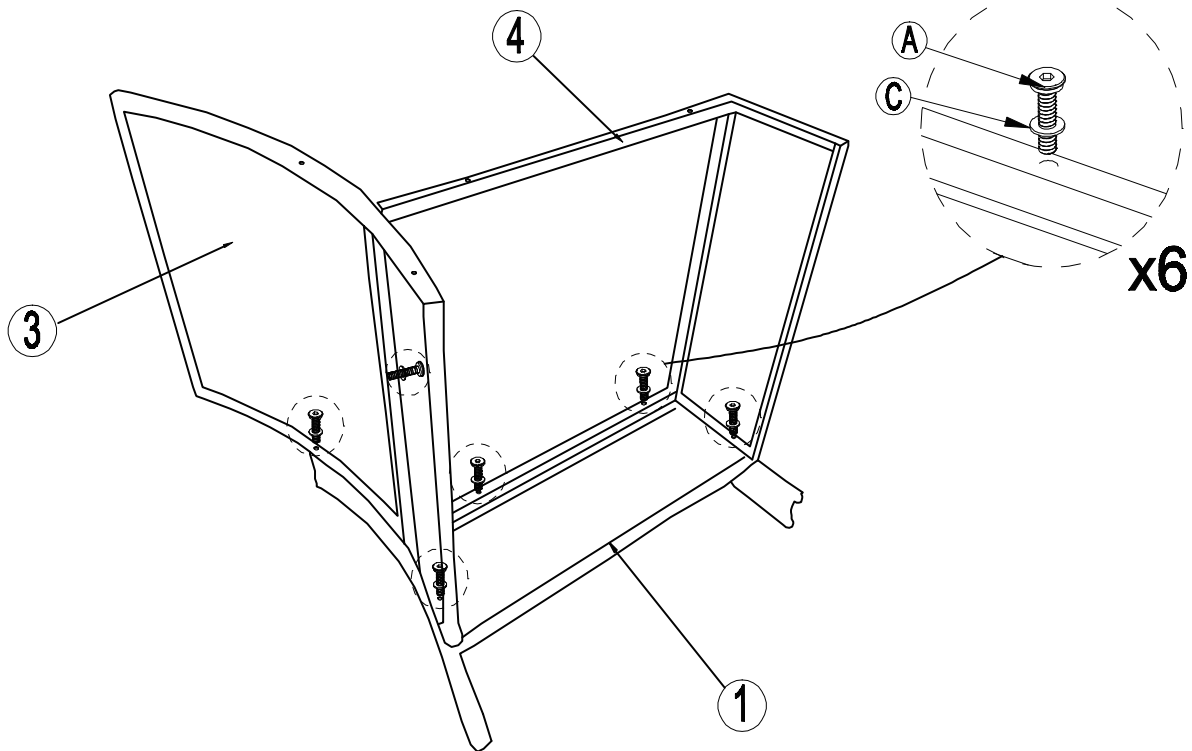

x2

02

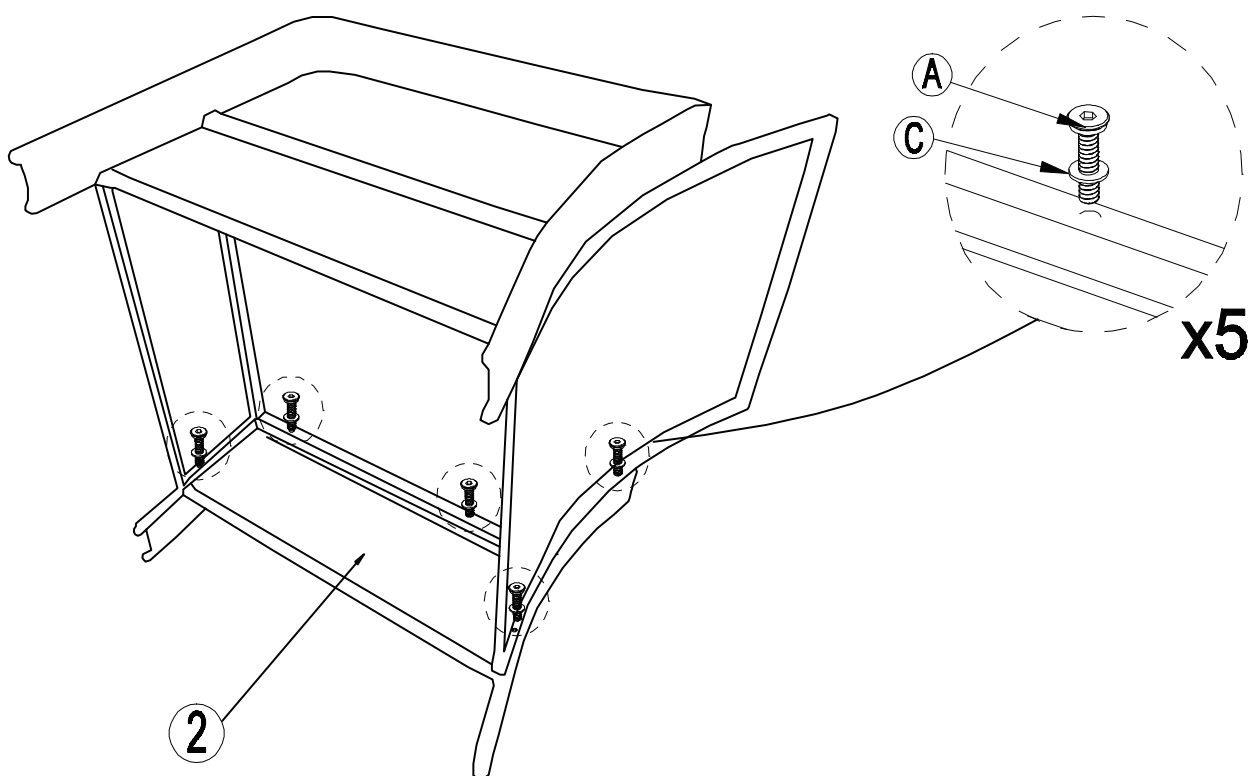

x2

