

---

# DESCRIPTION

## TV Chair With Footstool





This product is designed to seat people up to a maximum of 115kgs (18 stone)

Check and re-tighten parts/nuts & bolts every three months

For any missing/damaged parts, please contact your retailer.

Please retain these instructions for future reference and in case of any queries, please quote the following batch number to your retailer. (The batch number is also located on the underside of the seat pad or footstool pad)

**IMPORTANT:** Please read this manual carefully before beginning assembly of this product. Keep this manual for future reference.

## SAFETY INFORMATION

Identify all the parts and hardware.

Do not discard of the packaging until you have checked that you have all of the parts and hardware required. Hardware package may have spare parts.

**WARNING:** This item contains small parts which can be swallowed by children and pets. Keep children and pets away during assembly. To avoid danger of suffocation, always keep plastic bags away from children and pets.

We recommend that you assemble this unit on a carpeted floor to avoid scratches. We do not recommend the use of power tools for assembly as this could damage the unit. Only use manual tools.

Requires 2 people for ease of assembly.

## CARE and MAINTENANCE

Wipe regularly with clean water and a damp, clean, soft white cloth

General cleaning can be done as needed with a mild detergent and water solution. Always rinse with clean water and dry.

For heavy soiling, dampen a soft white cloth or soft bristle brush. Use care as scrubbing can damage the surface.

More difficult stains can be treated, but this should be occasional, not daily, cleaning.

ANY cleaning solution used must be removed with clean water and a clean white cloth. Cleaning residue left on the material can cause it to dry out and crack, or affect the color.

DO NOT use any cleaners with corrosive ingredients (lye, acids or ammonia).

## PRE-ASSEMBLY INFORMATION

### PARTS DESCRIPTION

**A**

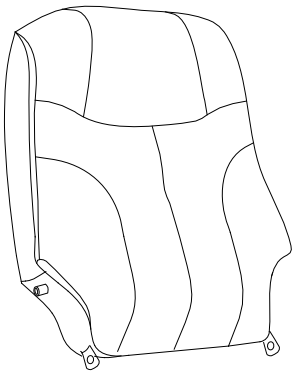

Seat Back  
Qty 1

**B**

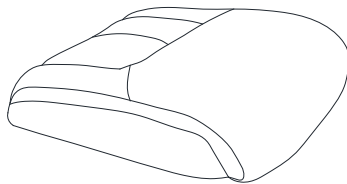

Seat pad  
Qty 1

**C**

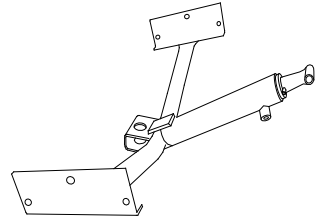

U-frame  
Qty 1

**D**

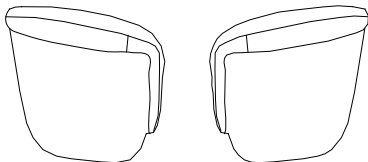

LHF & RHF Arm  
Qty 1 set

**E**

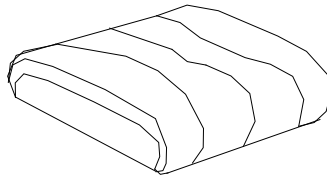

Footstool Pad  
Qty 1

**F**

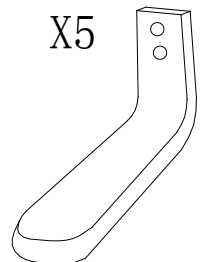

Chair Leg  
Qty 5

# PRE-ASSEMBLY INFORMATION

## PARTS DESCRIPTION

**G**

X4

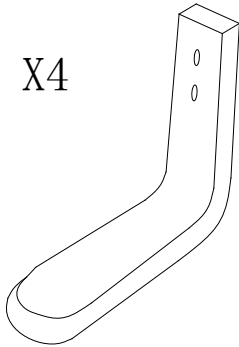

Footstool Leg  
Qty 4

**H**

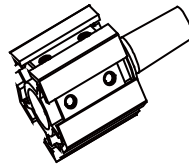

Chair Spindle  
Qty 1

**I**

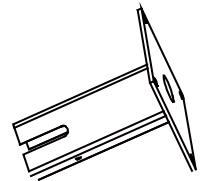

Footstool Spindle  
Qty 1

**J**



Footstool Plate  
Qty 4

**K**

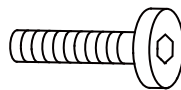

Screws  
Qty 18

**L**

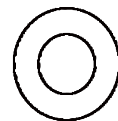

Washers  
Qty 18

## PRE-ASSEMBLY INFORMATION

### PARTS DESCRIPTION

M

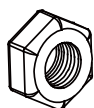

Nuts  
Qty 1

N

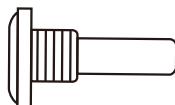

Bolt & Clip  
Qty 2

O

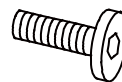

Screw  
Qty 6

P

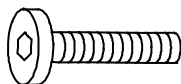

Screw  
Qty 4

Q

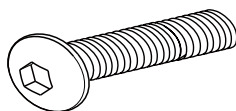

Screw  
Qty 2

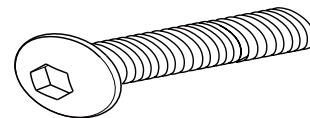

R



Spanner  
Qty 1

# PRE-ASSEMBLY INFORMATION

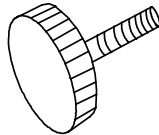
## PARTS DESCRIPTION

<p><b>S</b></p>  <p>Allen Key Qty 1</p>	<p><b>T</b></p>  <p>Recliner Handle Qty 1</p>	<p><b>U</b></p>  <p>Spanner Qty 1</p>
<p><b>V</b></p>  <p>Spanner Qty 8</p>		

# ASSEMBLY

## STEP 1

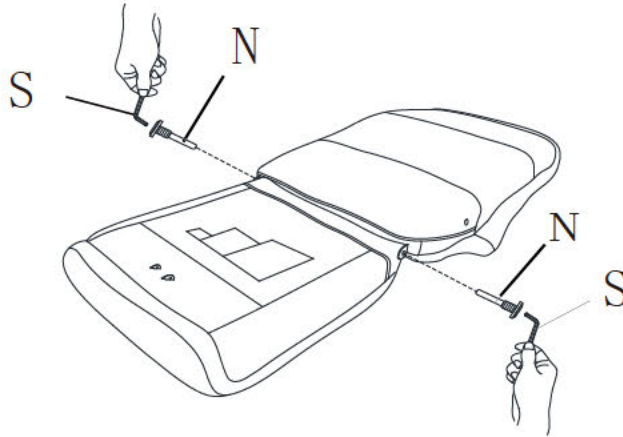

## STEP 2

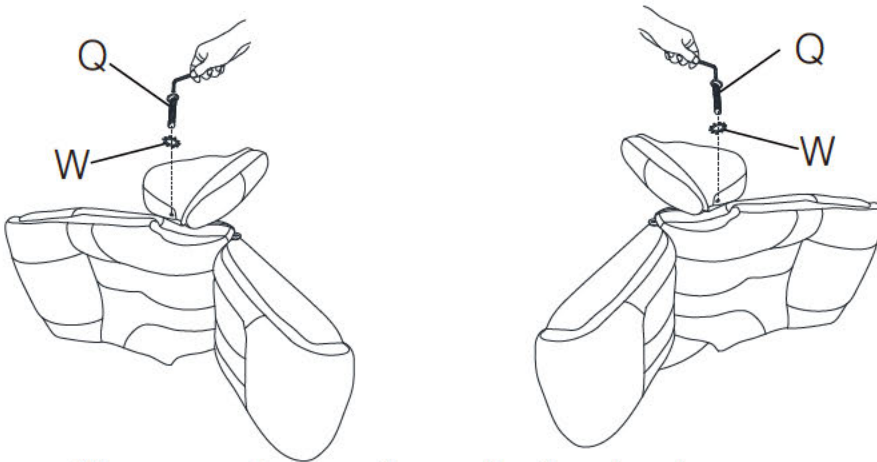

Place arm at an angle as displayed and partially fasten bolt.

---

## STEP 3

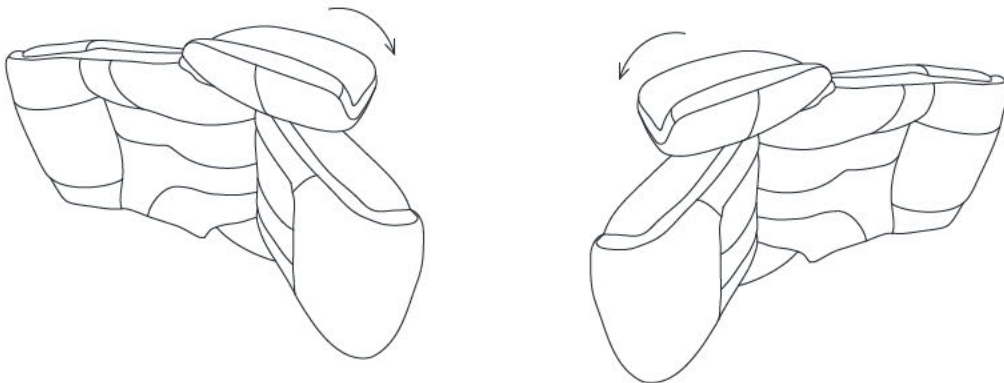

## ASSEMBLY

### STEP 4

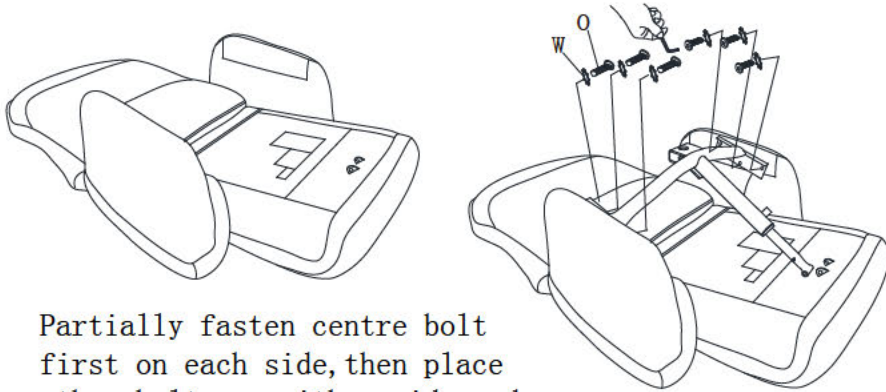

Partially fasten centre bolt first on each side, then place other bolts on either side and fully tighten.

### STEP 5

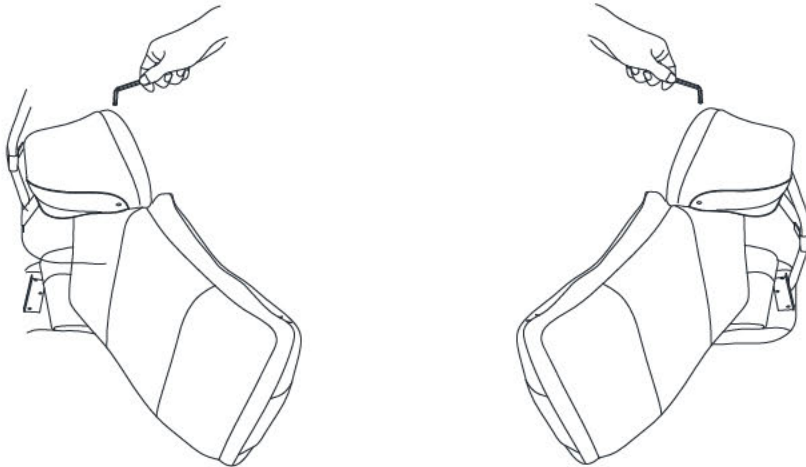

Fully tighten armrest bolts and close the zippers.

### STEP 6

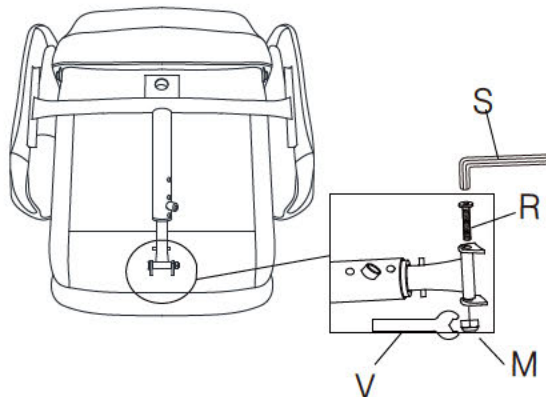

# ASSEMBLY

## STEP 7

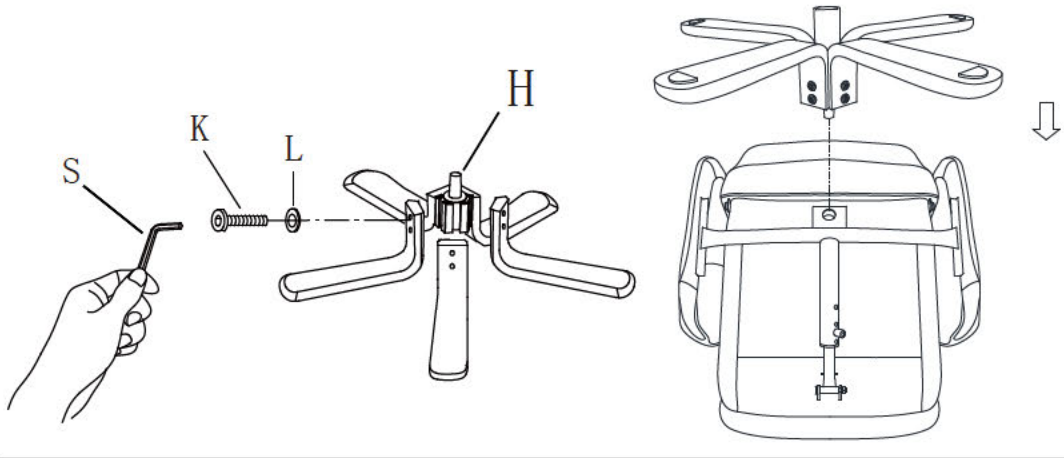

## STEP 8



## STEP 9

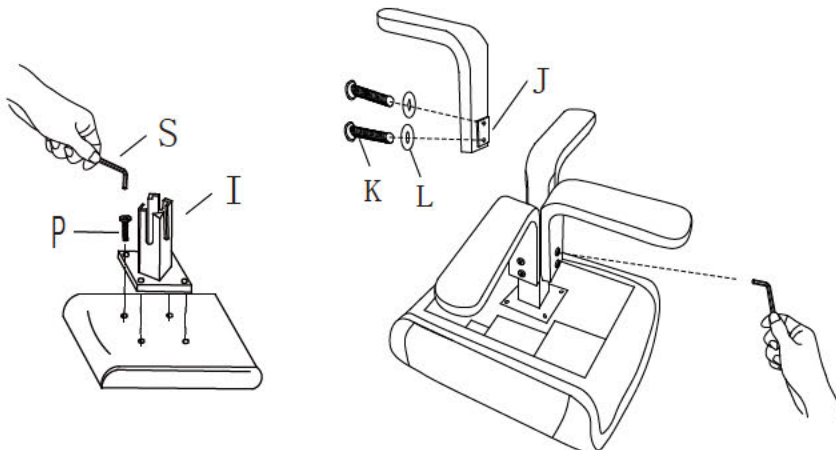

## WARRANTY

Thank you for purchasing a product from . These products have been made to demanding, high-quality standards and are guaranteed for domestic use against manufacturing faults for a period of 12 months from the date of purchase. This warranty does not affect your statutory rights.

We reserve the right to repair or replace the defective product, at its discretion.

This product is guaranteed for 12 months if used for normal purposes. Any warranty is invalid if the product has been overloaded or subject to neglect, improper use or an attempted repair by other than an authorized agent. Heavy-duty or daily professional/commercial usage are not guaranteed.

Due to continuous product improvement, we reserve the right to change the product specifications without prior notice.