

# ASSEMBLY INSTRUCTION

MODEL NUMBER:6-603Q

## NOTES:

Do not skip any step.

Do not fully tight screws until all the bed parts are assembled.









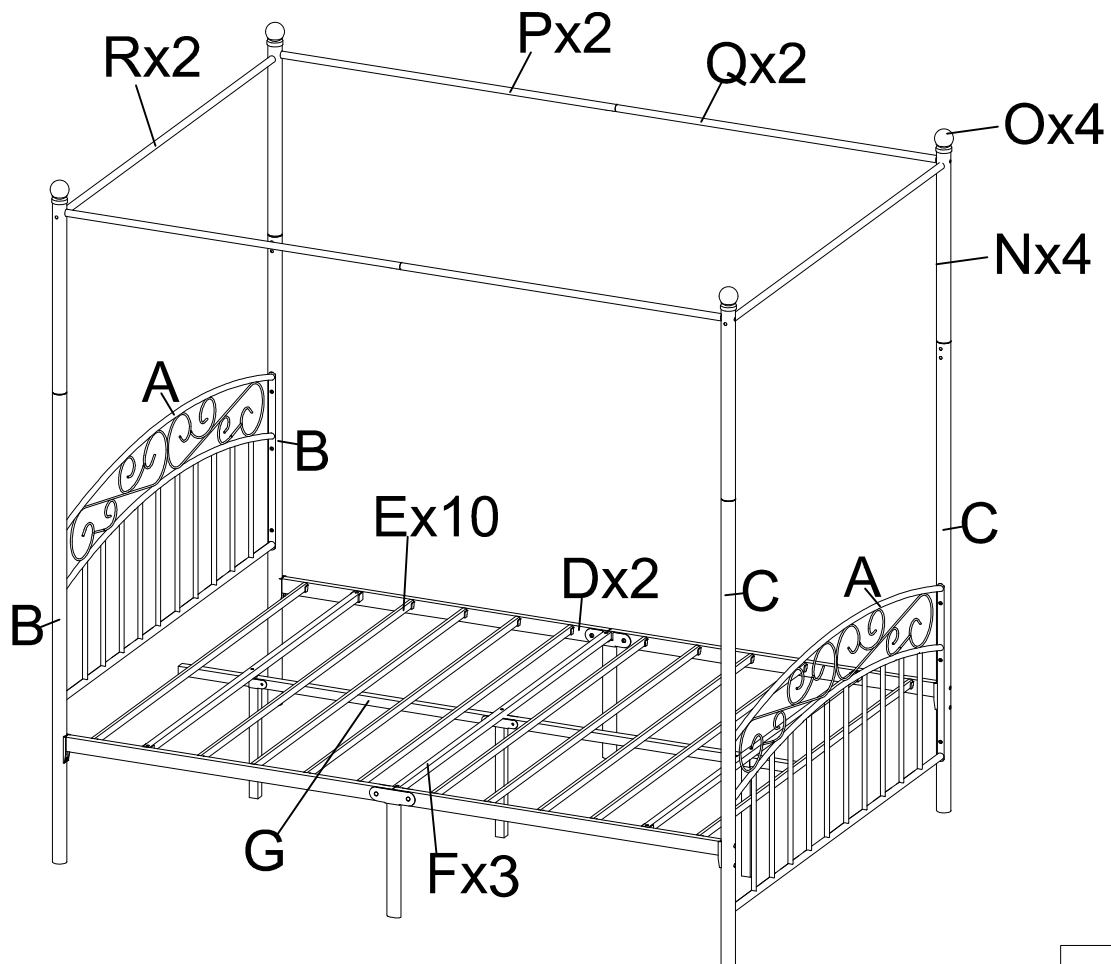

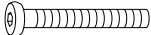
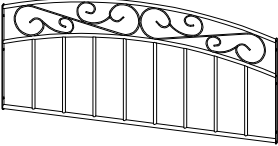
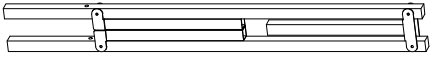

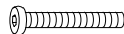
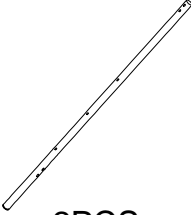



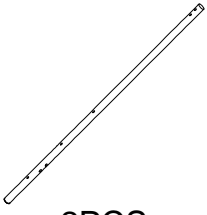
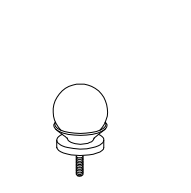

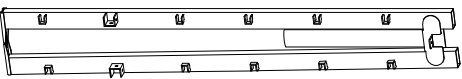
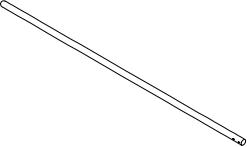
## WARNING:

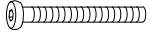
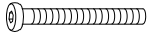
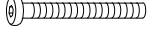
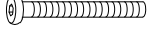

WARNIND FOR YOUNG CHILDREN-This product contains small components,please ensure that they are kept away from small children while assembling.

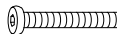
## Warranty Information:

We warranty this product to be free from defects in materials.This warranty covers one year from the date of original purchase.If u have an uer about bed ls contact our after -sale support email:



A	G	aa	 M8x55	4											
 2PCS	 1PC	bb	 M6x55	11											
B	N	cc	 M6x35	4											
 2PCS	 4PCS	dd	 M6x30	6											
C	O	ee	 M6x12	24											
 2PCS	 4PCS	ff		16											
D	P	gg		4											
 2PCS	 2PCS	hh		2											
E	Q	SPARE	ii		1										
 10PCS	 2PCS		aa		1										
F	R		bb		1										
 3PCS	 2PCS		cc		1										
			dd		1										
			ee		1										
			ff		1										
		gg		1											



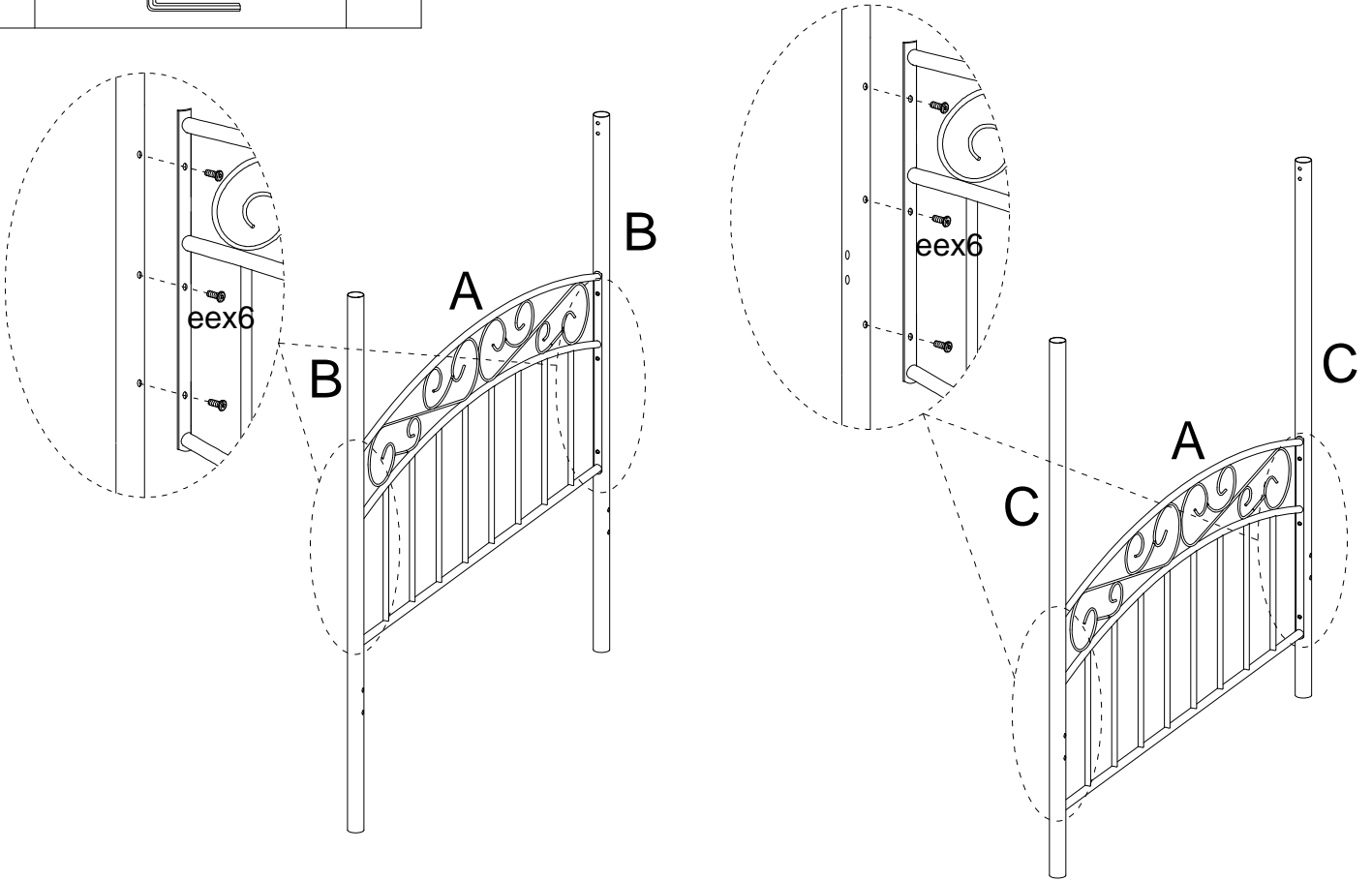

ee		M6x12	12
hh			1

Step 1

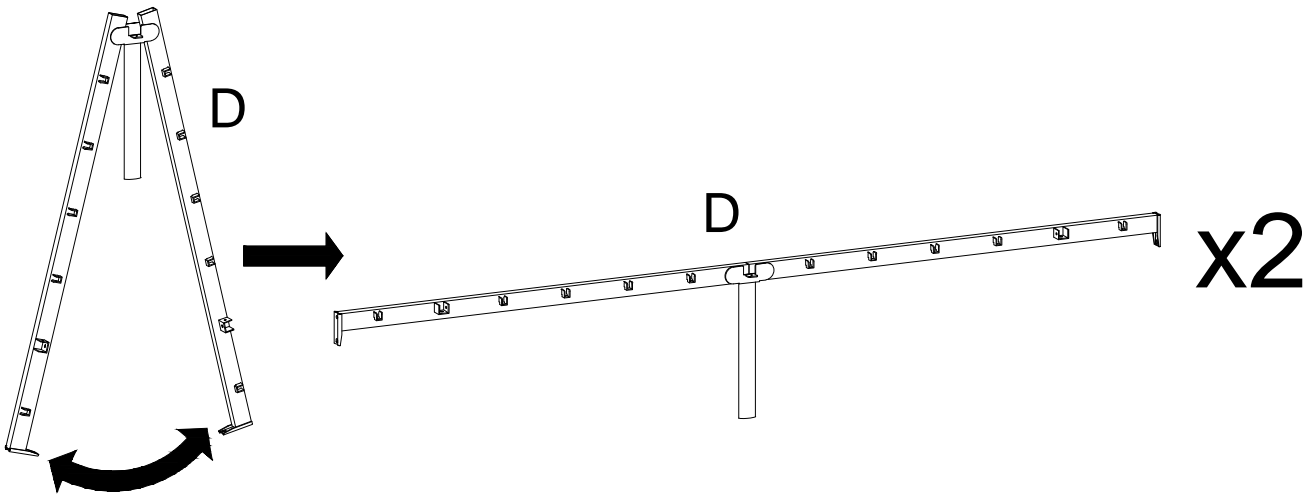

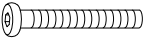

Step 2

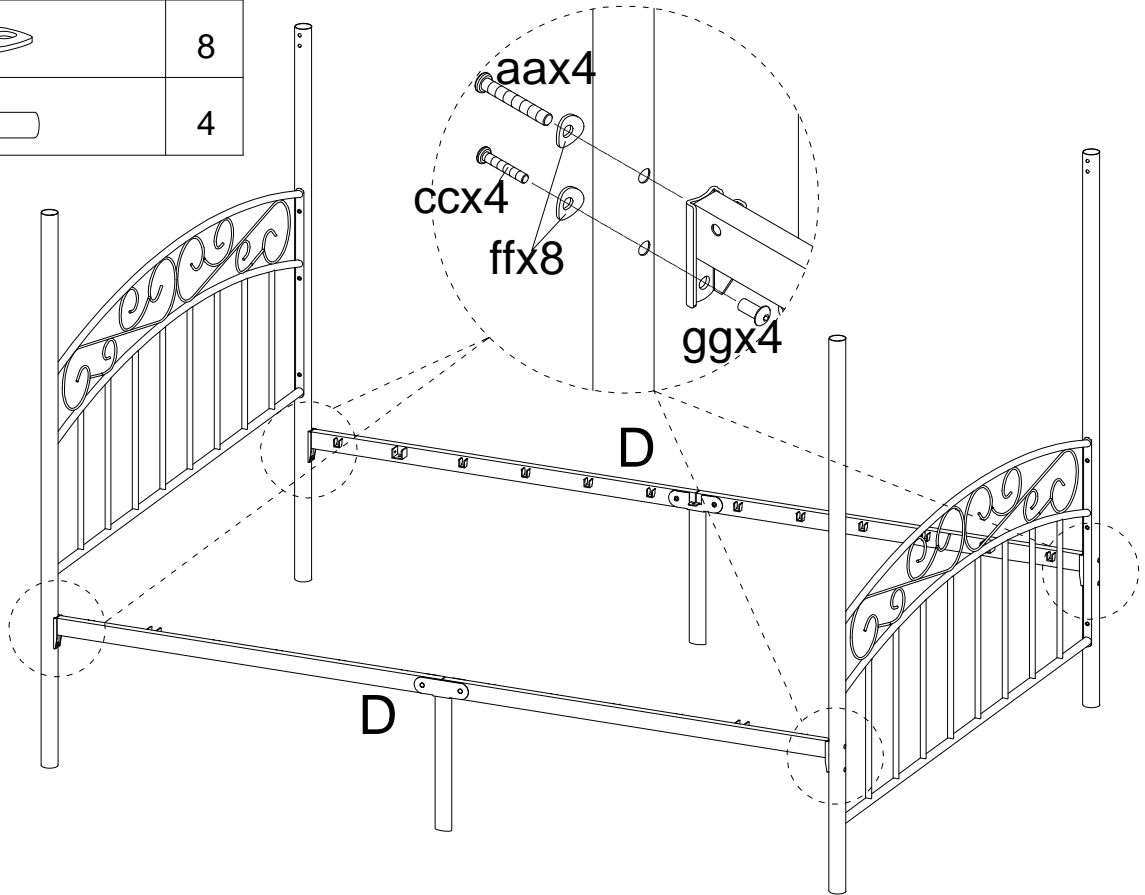

aa		M8x55	4	hh		2
cc		M6x35	4			
ff			8			
gg			4			

Step 3

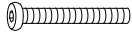

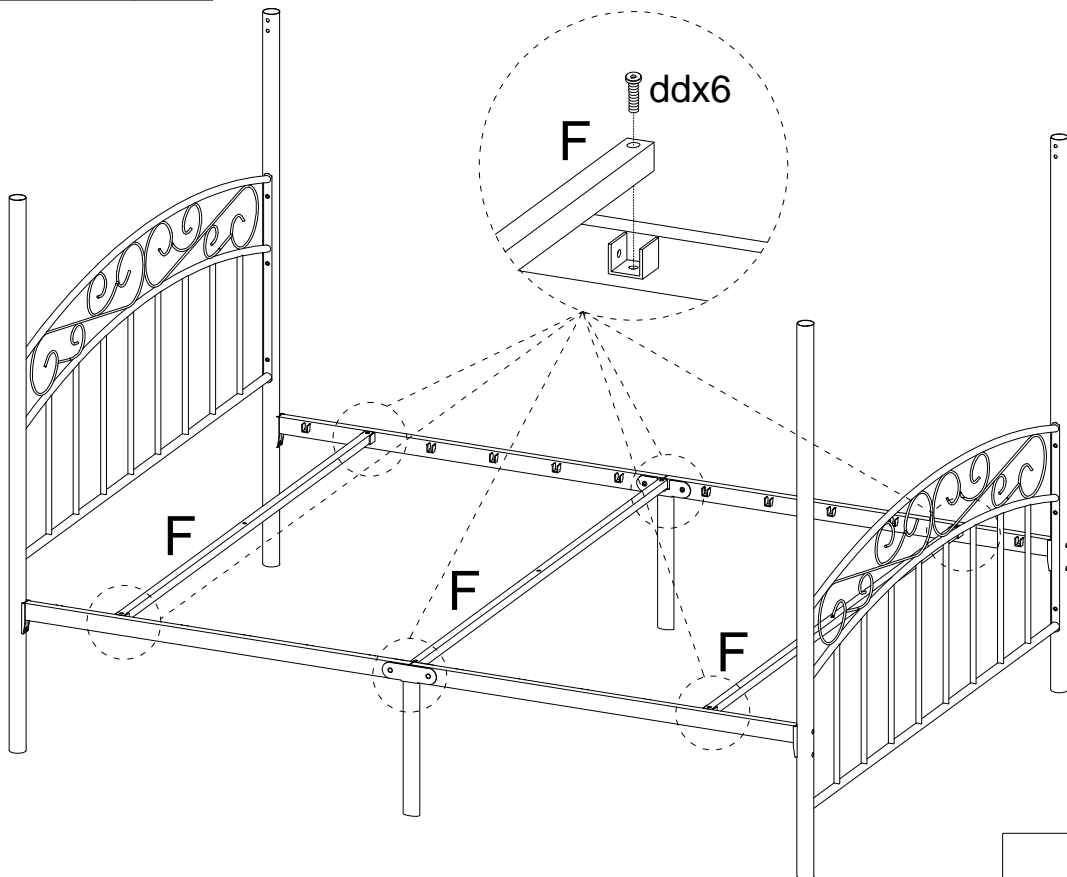

dd		M6x30	6			
hh			1			

Step 4

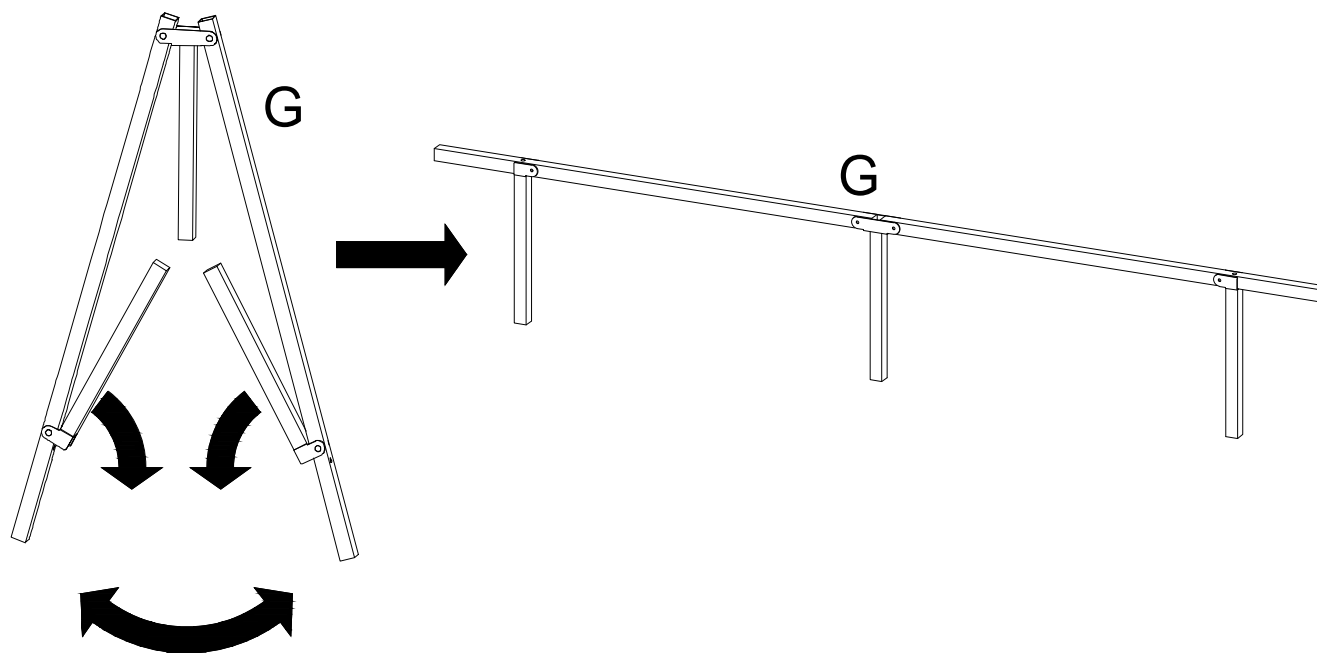



bb		M6x55	3
hh			1
ii			1

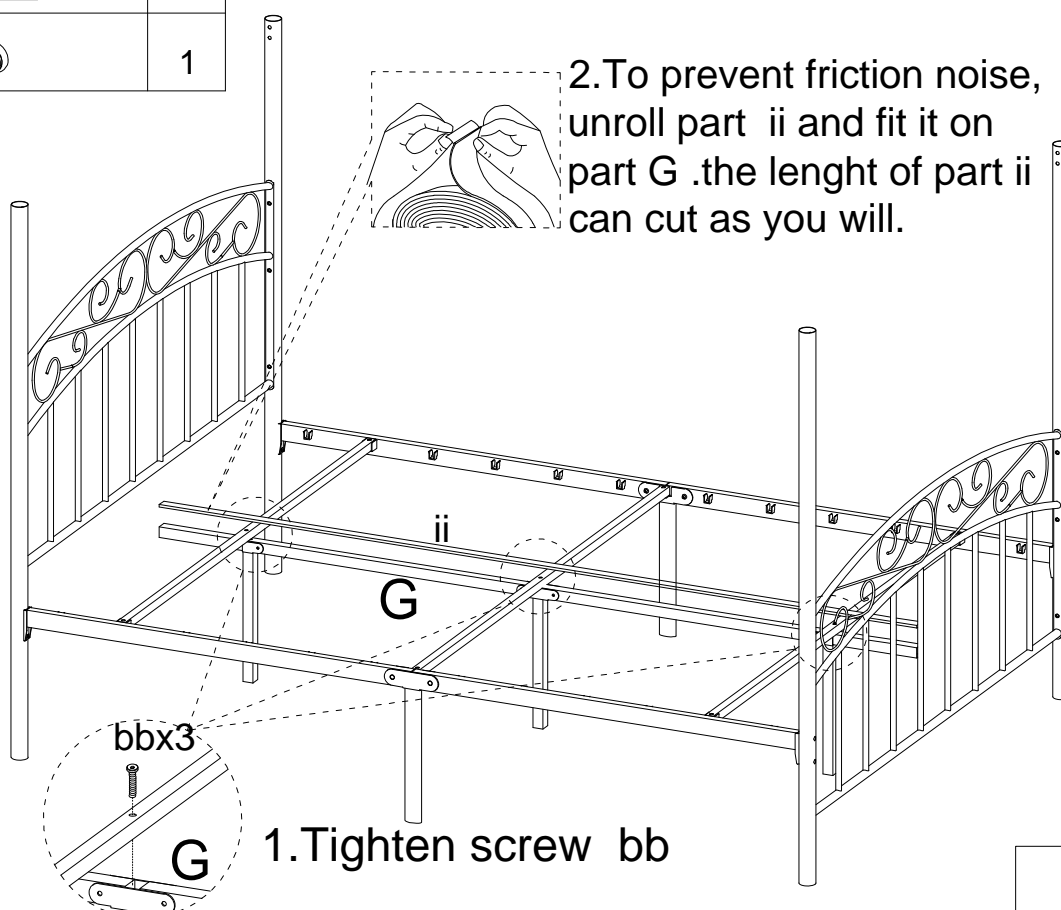



2.To prevent friction noise, unroll part ii and fit it on part G .the lenght of part ii can cut as you will.

1.Tighten screw bb

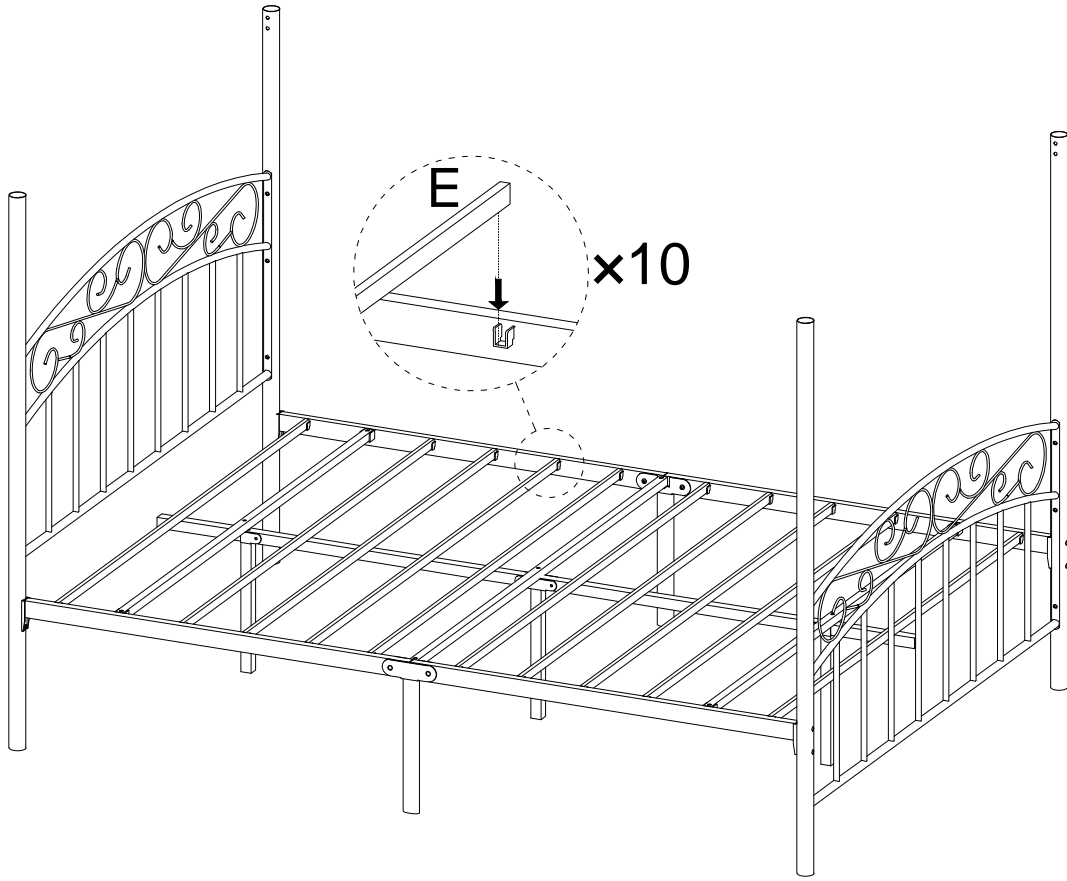



Step 7

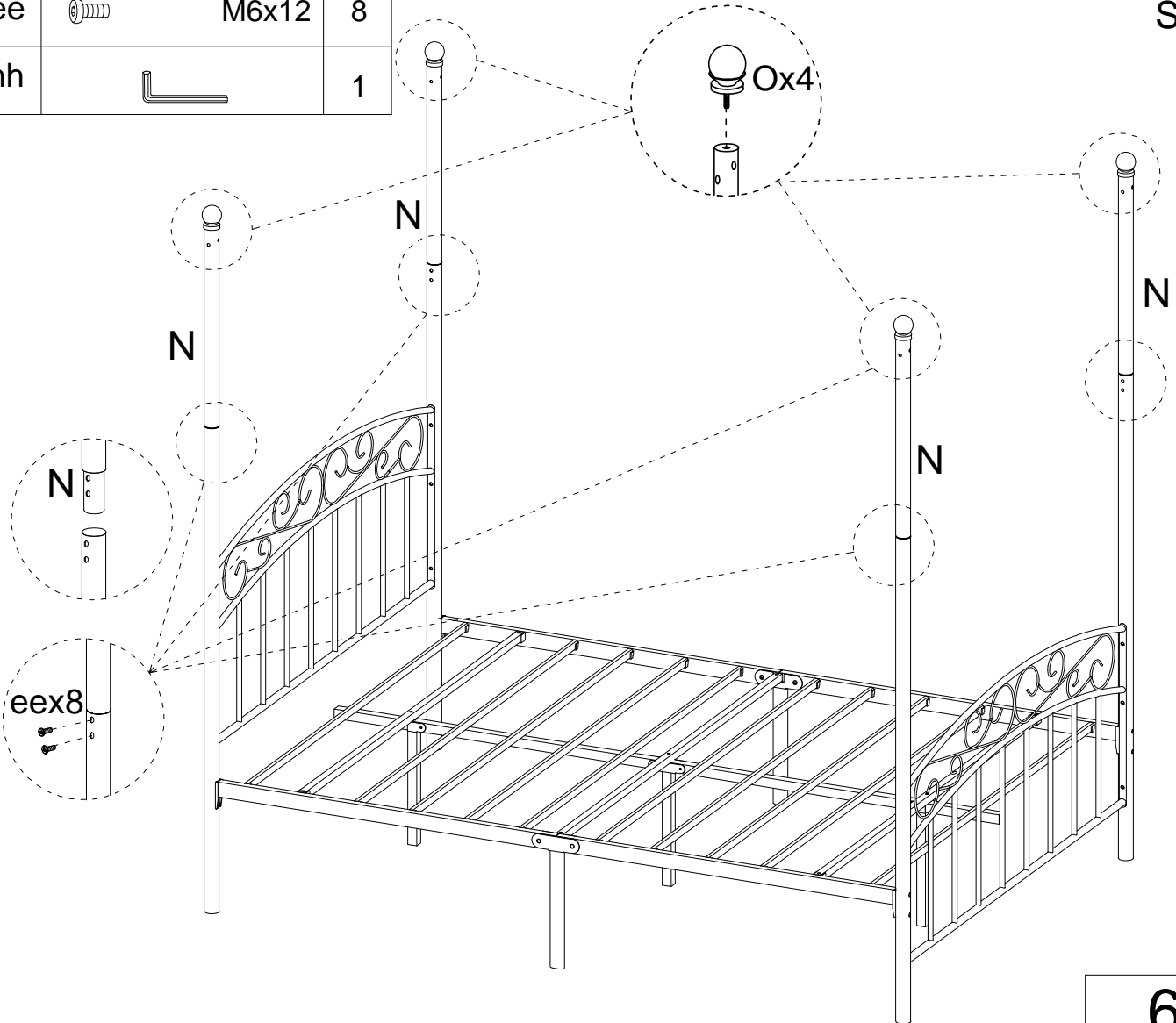

ee		M6x12	8
hh			1

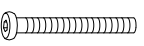
Step 8



bb		M6x55	8
ee		M6x12	4
hh			1
ff			8

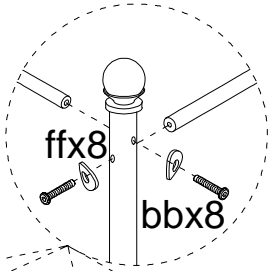
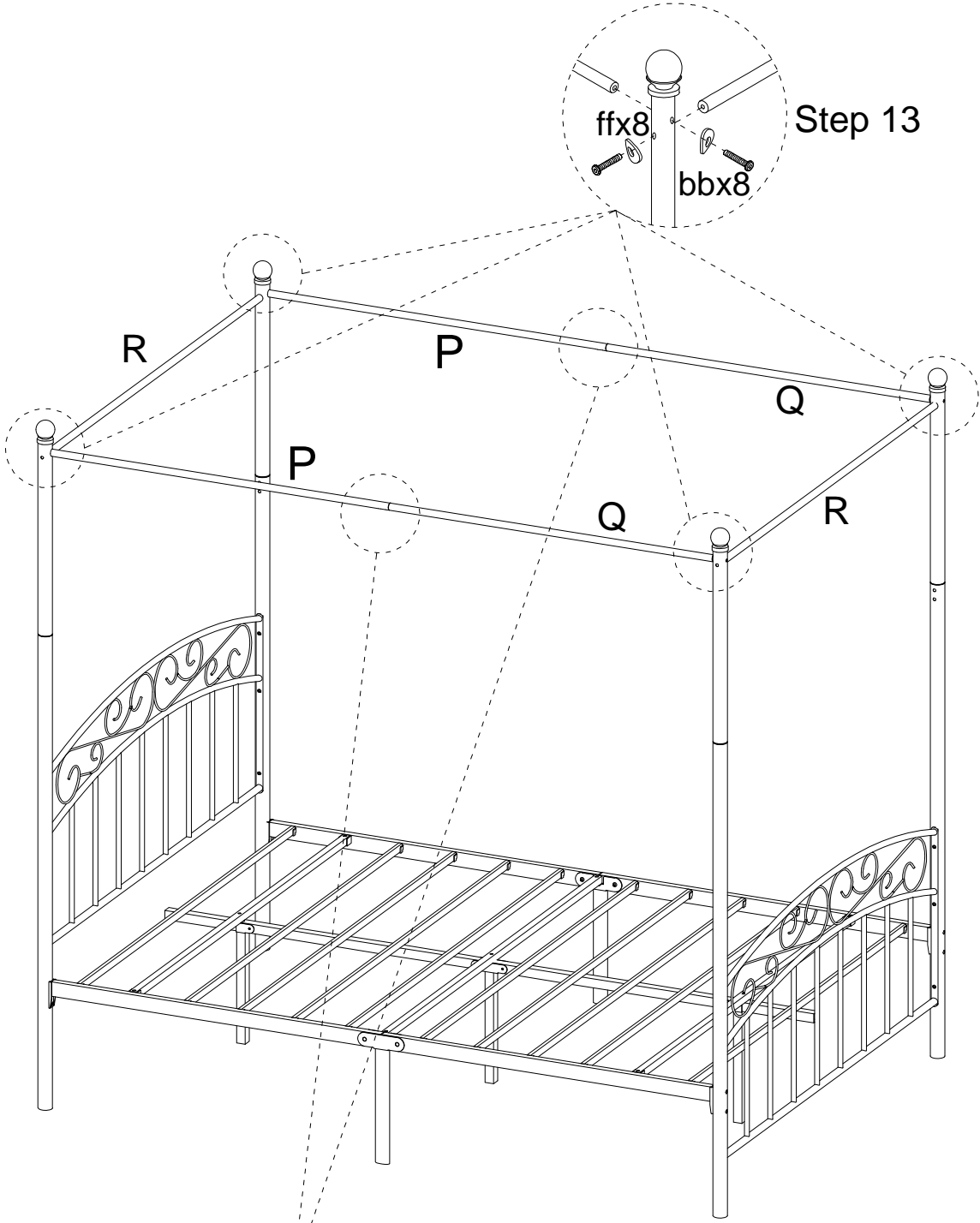

Step 13

Step 12

